



2014 **ROGUE**  
OWNER'S MANUAL

For your safety, read carefully and keep in this vehicle.

## FOREWORD

Welcome to the growing family of new NISSAN owners. This vehicle is delivered to you with confidence. It was produced using the latest techniques and strict quality control.

This manual was prepared to help you understand the operation and maintenance of your vehicle so that you may enjoy many miles (kilometers) of driving pleasure. Please read through this manual before operating your vehicle.

**A separate Warranty Information Booklet explains details about the warranties covering your vehicle. The “NISSAN Service and Maintenance Guide” explains details about maintaining and servicing your vehicle. Additionally, a separate Customer Care/Lemon Law Booklet (U.S. only) will explain how to resolve any concerns you may have with your vehicle, as well as clarify your rights under your state’s lemon law.**

Your NISSAN dealership knows your vehicle best. When you require any service or have any questions, they will be glad to assist you with the extensive resources available to them.

In addition to factory-installed options, your vehicle may also be equipped with additional accessories installed by NISSAN or by your NISSAN dealer prior to delivery. It is important that you familiarize yourself with all disclosures,

warnings, cautions and instructions concerning proper use of such accessories prior to operating the vehicle and/or accessory. See a NISSAN dealer for details concerning the particular accessories with which your vehicle is equipped.

## READ FIRST—THEN DRIVE SAFELY

Before driving your vehicle, please read this Owner’s Manual carefully. This will ensure familiarity with controls and maintenance requirements assisting you in the safe operation of your vehicle.

### WARNING

#### **IMPORTANT SAFETY INFORMATION REMINDERS FOR SAFETY!**

Follow these important driving rules to help ensure a safe and comfortable trip for you and your passengers!

- **NEVER** drive under the influence of alcohol or drugs.
- **ALWAYS** observe posted speed limits and never drive too fast for conditions.
- **ALWAYS** give your full attention to driving and avoid using vehicle features or taking other actions that could distract you.
- **ALWAYS** use your seat belts and appropriate child restraint systems. Preteen children should be seated in the rear seat.
- **ALWAYS** provide information about the proper use of vehicle safety features to all occupants of the vehicle.
- **ALWAYS** review this Owner’s Manual for important safety information.

## WHEN READING THE MANUAL

### ON-PAVEMENT AND OFF-ROAD DRIVING

**This vehicle will handle and maneuver differently from an ordinary passenger car because it has a higher center of gravity for off-road use. As with other vehicles with features of this type, failure to operate this vehicle correctly may result in loss of control or an accident.**

**Be sure to read “On-pavement and off-road driving precautions,” “Avoiding collision and rollover” and “Driving safety precautions” in the “Starting and driving” section of this manual.**

### MODIFICATION OF YOUR VEHICLE

**This vehicle should not be modified. Modification could affect its performance, safety or durability, and may even violate governmental regulations. In addition, damage or performance problems resulting from modifications may not be covered under NISSAN warranties.**

This manual includes information for all features and equipment available on this model. Features and equipment in your vehicle may vary depending on model, trim level, options selected, order, date of production, region or availability. Therefore, you may find information about features or equipment that are not included or installed on your vehicle.

All information, specifications and illustrations in this manual are those in effect at the time of printing. NISSAN reserves the right to change specifications, performance, design or component suppliers without notice and without obligation. From time to time, NISSAN may update or revise this manual to provide Owners with the most accurate information currently available. Please carefully read and retain with this manual all revision updates sent to you by NISSAN to ensure you have access to accurate and up-to-date information regarding your vehicle. Current versions of vehicle Owner's Manuals and any updates can also be found in the Owner section of the NISSAN website at <https://owners.nissanusa.com/nowners/navigation/manualsGuide>. If you have questions concerning any information in your Owner's Manual, contact NISSAN Consumer Affairs. See the NISSAN CUSTOMER CARE PROGRAM page in this Owner's Manual for contact information.

## IMPORTANT INFORMATION ABOUT THIS MANUAL

You will see various symbols in this manual. They are used in the following ways:

### WARNING

**This is used to indicate the presence of a hazard that could cause death or serious personal injury. To avoid or reduce the risk, the procedures must be followed precisely.**

### CAUTION

**This is used to indicate the presence of a hazard that could cause minor or moderate personal injury or damage to your vehicle. To avoid or reduce the risk, the procedures must be followed carefully.**

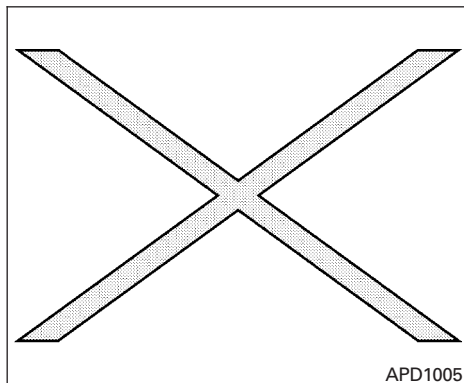

## CALIFORNIA PROPOSITION 65 WARNING

### WARNING

**Engine exhaust, some of its constituents, and certain vehicle components contain or emit chemicals known to the State of California to cause cancer and birth defects or other reproductive harm. In addition, certain fluids contained in vehicles and certain products of component wear contain or emit chemicals known to the State of California to cause cancer and birth defects or other reproductive harm.**

## CALIFORNIA PERCHLORATE ADVISORY

**Some vehicle parts, such as lithium batteries, may contain perchlorate material. The following advisory is provided: "Perchlorate Material – special handling may apply, See [www.dtsc.ca.gov/hazardouswaste/perchlorate/](http://www.dtsc.ca.gov/hazardouswaste/perchlorate/)".**

If you see this symbol, it means **"Do not do this"** or **"Do not let this happen."**



If you see a symbol similar to these in an illustration, it means the arrow points to the front of the vehicle.



Arrows in an illustration that are similar to these indicate movement or action.



Arrows in an illustration that are similar to these call attention to an item in the illustration.



BLUETOOTH® is a trademark owned by Bluetooth SIG, Inc. and licensed to Visteon and Bosch.

SiriusXM Satellite Radio requires subscription, sold separately. Not available in Alaska, Hawaii or Guam. For more information, visit [www.siriusxm.com](http://www.siriusxm.com).



© 2013 NISSAN NORTH AMERICA, INC.

All rights reserved. No part of this Owner's Manual may be reproduced or stored in a retrieval system, or transmitted in any form, or by any means, electronic, mechanical, photocopying, recording or otherwise, without the prior written permission of Nissan North America, Inc.

# NISSAN CUSTOMER CARE PROGRAM

## NISSAN CARES . . .

Both NISSAN and your NISSAN dealer are dedicated to serving all your automotive needs. Your satisfaction with your vehicle and your NISSAN dealer are our primary concerns. Your NISSAN dealer is always available to assist you with all your automobile sales and service needs.

However, if there is something that your NISSAN dealer cannot assist you with or you would like to provide NISSAN directly with comments or questions, please contact the NISSAN Consumer Affairs Department using our toll-free number:

**For U.S. customers**  
**1-800-NISSAN-1**  
**(1-800-647-7261)**

**For Canadian customers**  
**1-800-387-0122**

The Consumer Affairs Department will ask for the following information:

- Your name, address, and telephone number
- Vehicle identification number (attached to the top of the instrument panel on the driver's side)
- Date of purchase
- Current odometer reading
- Your NISSAN dealer's name
- Your comments or questions

OR

You can write to NISSAN with the information at:

**For U.S. customers**  
**Nissan North America, Inc.**  
**Consumer Affairs Department**  
**P.O. Box 685003**  
**Franklin, TN 37068-5003**  
**or via e-mail at:**  
**nnaconsumeraffairs@nissan-usa.com**

**For Canadian customers**  
**Nissan Canada Inc.**  
**5290 Orbitor Drive**  
**Mississauga, Ontario L4W 4Z5**  
**or via e-mail at:**  
**information.centre@nissancanada.com**

If you prefer, visit us at:  
**www.nissanusa.com** (for U.S. customers) or  
**www.nissan.ca** (for Canadian customers)

We appreciate your interest in NISSAN and thank you for buying a quality NISSAN vehicle.

# Table of Contents

<b>Illustrated table of contents</b>	<b>0</b>
<b>Safety—Seats, seat belts and supplemental restraint system</b>	<b>1</b>
<b>Instruments and controls</b>	<b>2</b>
<b>Pre-driving checks and adjustments</b>	<b>3</b>
<b>Monitor, climate, audio, phone and voice recognition systems</b>	<b>4</b>
<b>Starting and driving</b>	<b>5</b>
<b>In case of emergency</b>	<b>6</b>
<b>Appearance and care</b>	<b>7</b>
<b>Maintenance and do-it-yourself</b>	<b>8</b>
<b>Technical and consumer information</b>	<b>9</b>
<b>Index</b>	<b>10</b>



# 0 Illustrated table of contents

Air bags, seat belts and child restraints .....	0-2
Exterior front .....	0-3
Exterior rear .....	0-4
Passenger compartment .....	0-5

Instrument panel.....	0-6
Engine compartment check locations .....	0-8
Warning/indicator lights .....	0-9



## AIR BAGS, SEAT BELTS AND CHILD RESTRAINTS

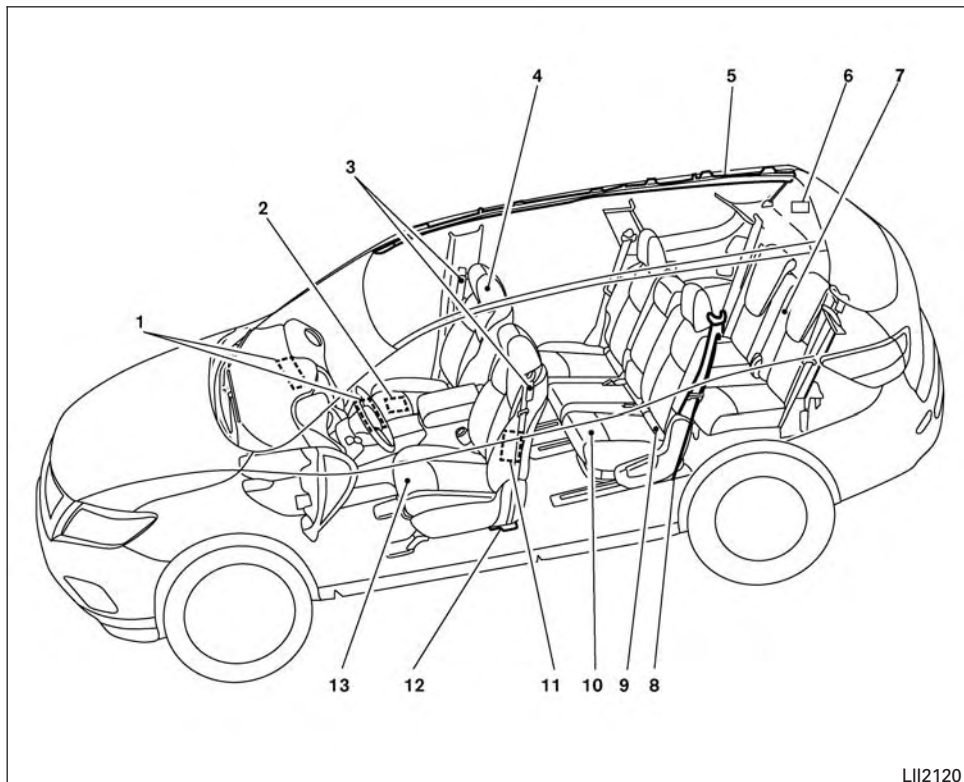

1. Supplemental front-impact air bags (P. 1-41)
2. Occupant classification sensor (weight sensor) (P. 1-56)
3. Seat belts (P. 1-13)
4. Head restraints/headrests (P. 1-6)
5. Roof-mounted curtain side-impact and rollover supplemental air bag (P. 1-41)
6. 2nd row center position top tether strap (located on ceiling) (P. 1-26 )
7. Folding 3rd row bench (if so equipped) (P. 1-12)
8. 2nd row outboard seat top tether strap anchor (located on bottom of seatback) (P. 1-37)
9. LATCH (Lower Anchors and Tethers for Children) (P. 1-24)
10. Folding 2nd row bench (P. 1-5)
11. Front seat-mounted side-impact supplemental air bag (P. 1-41)
12. Seat belt with pretensioner (P. 1-55)
13. Seats (1st row) (P. 1-2)

**See the page number indicated in parentheses for operating details.**

LII2120

## EXTERIOR FRONT

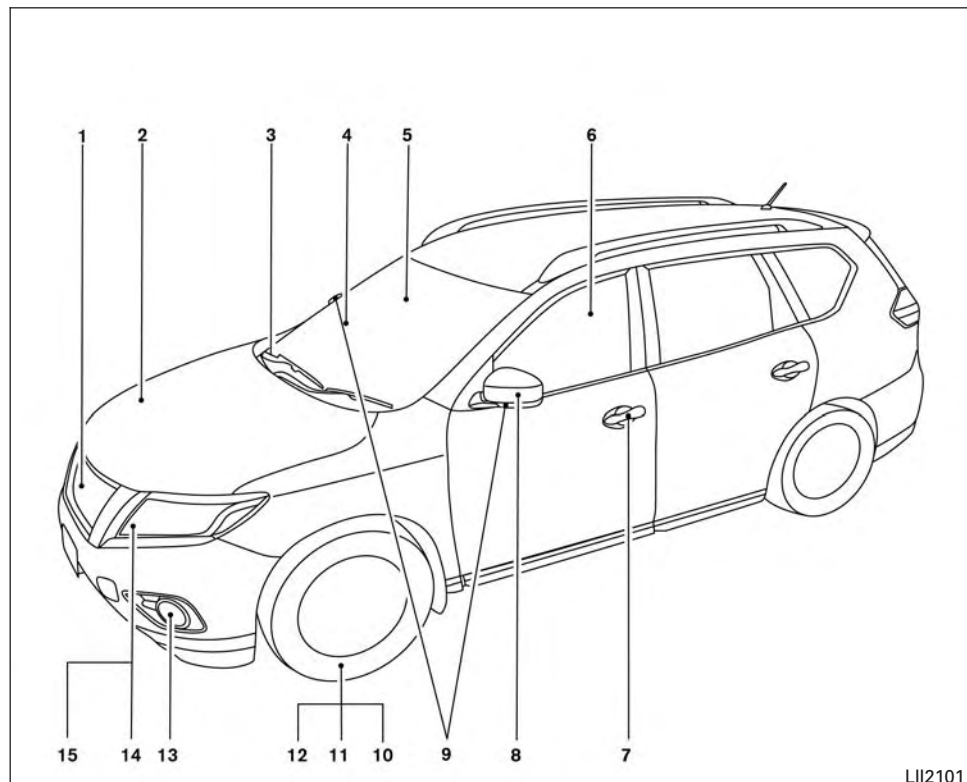

1. Front view camera (if so equipped) (P. 4-15)
2. Engine hood (P. 8-6)
3. Windshield wiper and washer switch, wiper blades (P. 2-32, 8-18)
4. Windshield-washer fluid (P. 8-18)
5. Windshield (P. 8-18)
6. Power windows (P. 2-50)
7. Door locks, NISSAN Intelligent Key® (if so equipped), NISSAN Jackknife key (if so equipped), keys (P. 3-5, 3-3, 3-2, 3-2)
8. Mirrors (P. 3-31)
9. Side view camera (if so equipped) (P. 4-15)
10. Tire pressure monitoring system (P. 8-32)
11. Flat tire (P. 6-3)
12. Tire chains (P. 8-40)
13. Fog light switch (if so equipped) (P. 2-38)
14. Replacing bulbs (P. 8-27)
15. Headlight and turn signal switch (P. 2-35)

**See the page number indicated in parentheses for operating details.**

LII2101

## EXTERIOR REAR

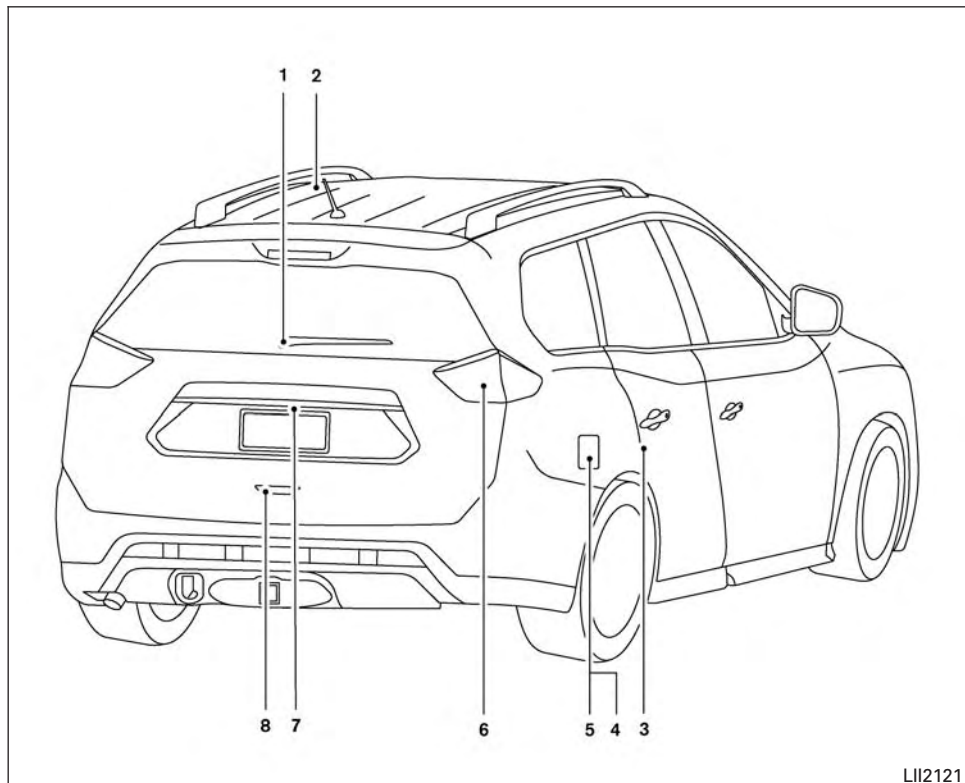

1. Rear window wiper and washer switch (P. 2-33)
2. Antenna (P. 4-77)
3. Child safety rear door lock (P. 3-7)
4. Fuel-filler door (P. 3-27)
5. Fuel-filler cap, fuel recommendation (P. 3-27, P. 9-4 )
6. Replacing bulbs (P. 8-27)
7. Rearview camera (if so equipped) (P. 4-15)
8. Liftgate release (power - P. 3-23, manual - P. 3-23)

**See the page number indicated in parentheses for operating details.**

LII2121

## PASSENGER COMPARTMENT

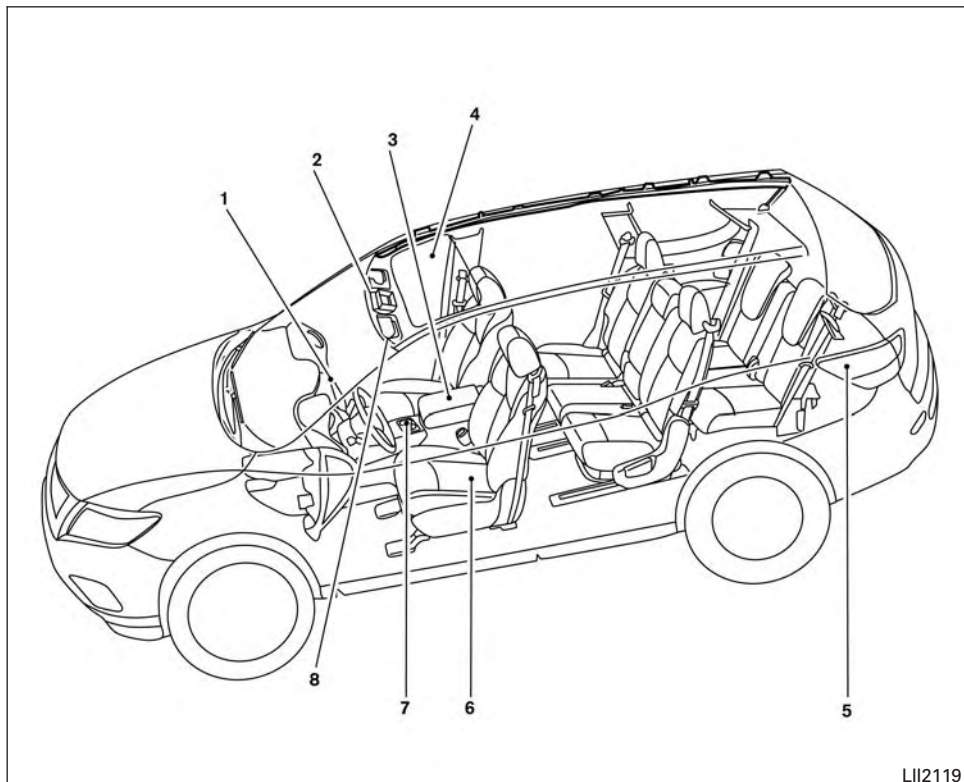

1. Glove box (P. 2-46)
2. Map lights (P. 2-55)
3. Console box (P. 2-44)
4. Power moonroof (if so equipped)  
(P. 2-52)
5. Luggage hooks (P. 2-48)
6. Seats (P. 1-2)
7. Cup holders (P. 2-45)
8. Sun visors (P. 3-30)

**See the page number indicated in parentheses for operating details.**

LII2119

## INSTRUMENT PANEL

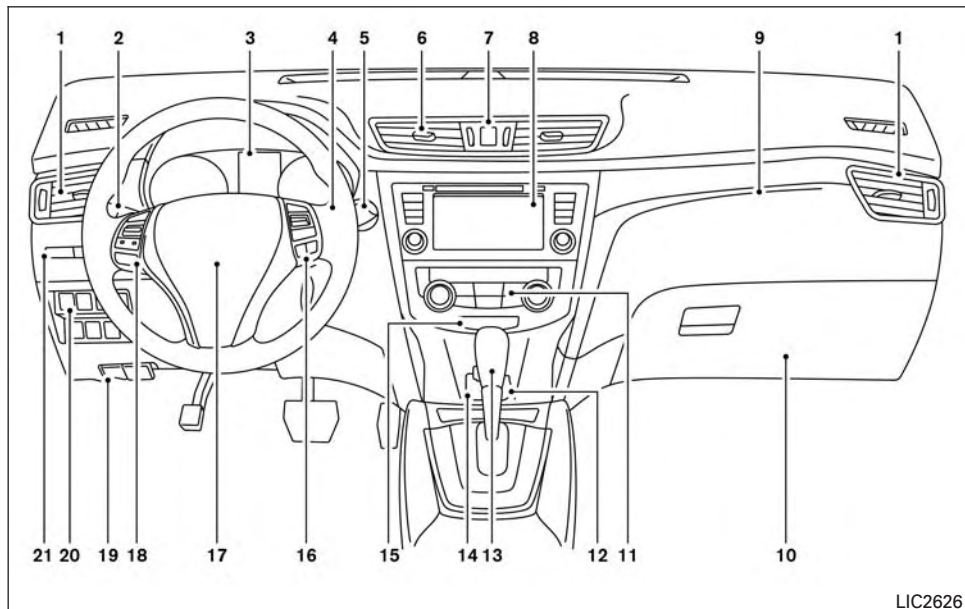

1. Vent (P. 4-25)
2. Headlight/fog light (if so equipped)/turn signal switch (P. 2-35)
3. Meters, gauges, warning/indicator lights and Vehicle Information Display (P. 2-3, P.2-17)

4. Windshield wiper/washer switch and rear window wiper/washer switch (P. 2-32, P. 2-33)/Ignition switch (if so equipped) (P. 5-8)
5. Push-button ignition switch (if so equipped) (P. 5-11)

6. Vent (P. 4-25)
7. Hazard warning flasher switch (P. 6-2)
8. Radio (P. 4-37)/Navigation system\* (if so equipped)
9. Front passenger supplemental air bag (P. 1-41)
10. Glove box (P. 2-46)
11. Heater and air conditioning controls (P. 4-26)
12. Power outlet (P. 2-42)
13. Shift lever (P. 5-16)
14. Auxiliary jack (P. 1-41)/USB port (P. 4-64)
15. Front passenger air bag status light (P. 1-41)
16. Cruise control main/set switches (P. 5-27/Bluetooth Hands-Free Phone System (if so equipped) (P. 4-37)
17. Driver supplemental air bag/Horn (P.1-41, P. 2-38)
18. Control panel and Vehicle Information Display switches (P.2-17)
19. Hood release (P. 3-22)/Fuel door release (P. 3-27)

- 20. Vehicle Dynamic Control (VDC) OFF switch (P. 2-40)
  - Sport mode switch (P. 2-40)
  - Power liftgate switch (if so equipped) (P.3-23)
  - Power liftgate main switch (if so equipped) (P. 3-26)
  - Warning systems switch (if so equipped) (P.2-42)
  - All-Wheel Drive (AWD) lock switch (if so equipped) (P.2-40)
  - Hill descent control switch (if so equipped) (P.2-41)
- 21. Instrument brightness control (P. 2-37)/Twin trip odometer reset switch (P. 2-4)

\*: Refer to the separate Navigation System Owner's Manual (if so equipped).

**See the page number indicated in parentheses for operating details.**

## ENGINE COMPARTMENT CHECK LOCATIONS

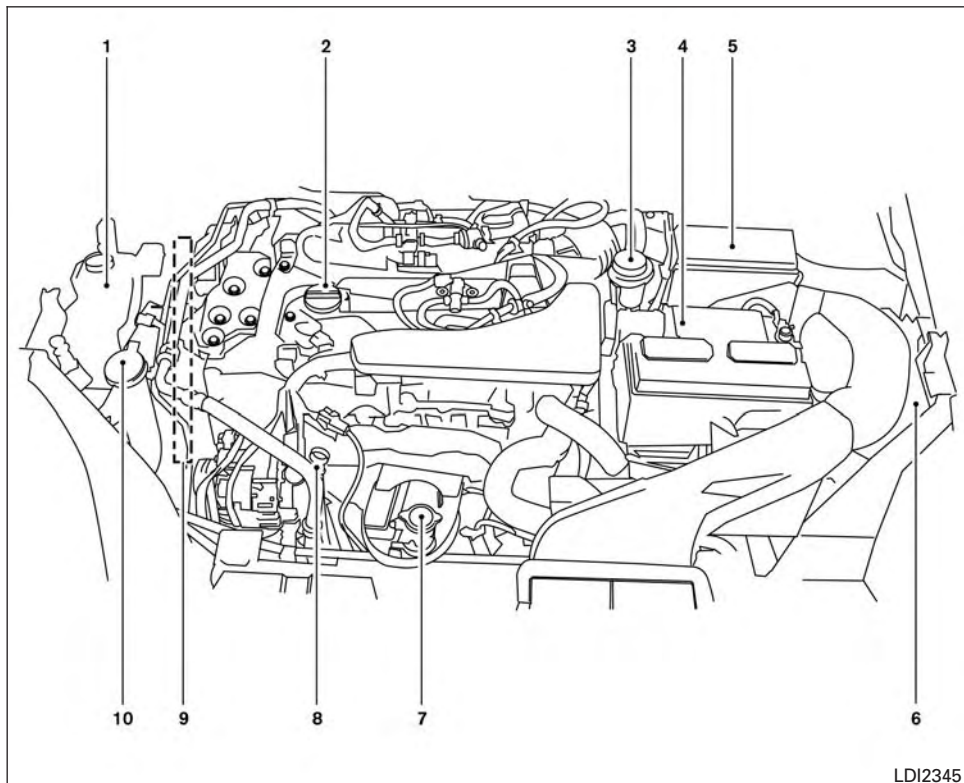















### QR25DE engine







1. Coolant reservoir (P. 8-12)
2. Oil filler cap (P. 8-21)
3. Brake fluid reservoir (P. 8-21)
4. Battery (P. 8-9)
5. Air cleaner (P. 8-9)
6. Fuse/fuseable link box (P. 8-21)
7. Radiator cap (P. 8-17)
8. Oil dip stick (P. 8-16)
9. Drive belt location (P. 8-16)
10. Windshield-washer fluid reservoir (P. 8-13)

**See the page number indicated in parentheses for operating details.**



## WARNING/INDICATOR LIGHTS

Warning light	Name	Page
 or 	Anti-lock Braking System (ABS) warning light	2-10
 or 	Brake warning light	2-10
	Charge warning light	2-10
	Low tire pressure warning light	2-11
	Master warning light	2-12
	Power steering warning light	2-13

Warning light	Name	Page
	Seat belt warning light and chime	2-13
	Supplemental air bag warning light	2-14
Indicator light	Name	Page
	All Wheel Drive (AWD) indicator light (if so equipped)	2-14
	All Wheel Drive (AWD) AUTO indicator light (if so equipped)	2-14
	Front fog light indicator light (if so equipped)	2-14
	Front passenger air bag status light	2-14

Indicator light	Name	Page
	High beam indicator light (blue)	2-14
	Hill descent indicator light (if so equipped)	2-14
	Malfunction Indicator Light (MIL)	2-15
	Overdrive off indicator light	2-15
	Security indicator light	2-15
	Slip indicator light	2-16
	SPORT mode indicator light (if so equipped)	2-16



Indicator light	Name	Page
	Turn signal/hazard indicator lights	2-16
	Vehicle Dynamic Control (VDC) off indicator light	2-16

# 1 Safety—Seats, seat belts and supplemental restraint system

Seats .....	1-2	Child restraints .....	1-22
Front manual seat adjustment (if so equipped) .....	1-2	Precautions on child restraints .....	1-22
Front power seat adjustment (if so equipped) .....	1-4	LATCH (Lower Anchors and Tethers for CHildren) System .....	1-24
2nd row bench seat adjustment .....	1-5	Rear-facing child restraint installation using LATCH .....	1-27
Head restraints/Headrests .....	1-6	Rear-facing child restraint installation using the seat belts .....	1-29
Flexible seating .....	1-10	Forward-facing child restraint installation using LATCH .....	1-31
Seat belts .....	1-13	Forward-facing child restraint installation using the seat belts .....	1-33
Precautions on seat belt usage .....	1-13	Installing top tether strap (2nd row bench seat) .....	1-37
Pregnant women .....	1-16	Booster seats .....	1-38
Injured persons .....	1-16	Supplemental restraint system .....	1-41
Three-point type seat belt with retractor .....	1-16	Precautions on supplemental restraint system .....	1-41
Seat belt extenders .....	1-19	Supplemental air bag warning labels .....	1-56
Seat belt maintenance .....	1-19	Supplemental air bag warning light .....	1-56
Child safety .....	1-20		
Infants .....	1-21		
Small children .....	1-21		
Larger children .....	1-21		

## SEATS

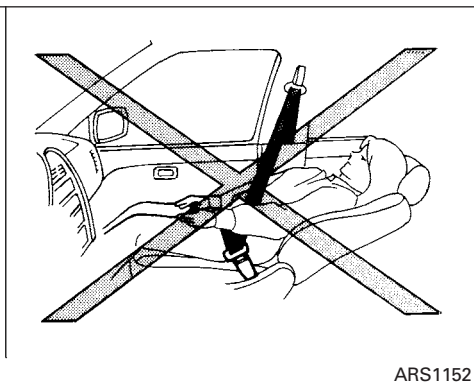
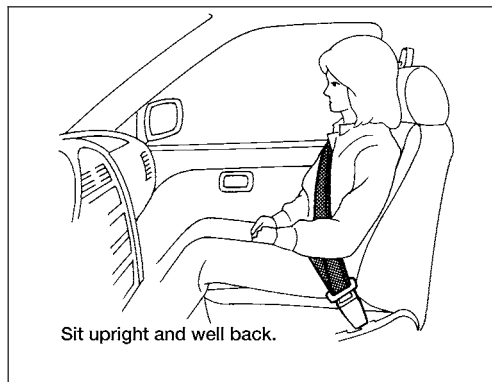

### **⚠ WARNING**

- Do not ride in a moving vehicle when the seatback is reclined. This can be dangerous. The shoulder belt will not be against your body. In an accident, you could be thrown into it and receive neck or other serious injuries. You could also slide under the lap belt and receive serious internal injuries.

- For the most effective protection when the vehicle is in motion, the seat should be upright. Always sit well back in the seat with both feet on the floor and adjust the seat properly. See “Precautions on seat belt usage” in this section.
- After adjustment, gently rock in the seat to make sure it is securely locked.
- Do not leave children unattended inside the vehicle. They could unknowingly activate switches or controls. Unattended children could become involved in serious accidents.

- Do not adjust the driver’s seat while driving so full attention may be given to vehicle operation. The seat may move suddenly and could cause loss of control of the vehicle.
- The seatback should not be reclined any more than needed for comfort. Seat belts are most effective when the passenger sits well back and straight up in the seat. If the seatback is reclined, the risk of sliding under the lap belt and being injured is increased.

### **⚠ CAUTION**

When adjusting the seat positions, be sure not to contact any moving parts to avoid possible injuries and/or damage.

### FRONT MANUAL SEAT ADJUSTMENT (if so equipped)

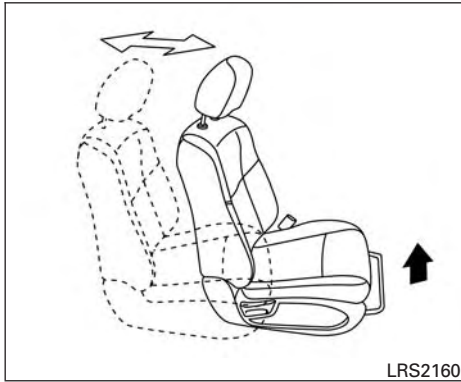

### Forward and backward

Pull the center of the bar up and hold it while you slide the seat forward or backward to the desired position. Release the bar to lock the seat in position.

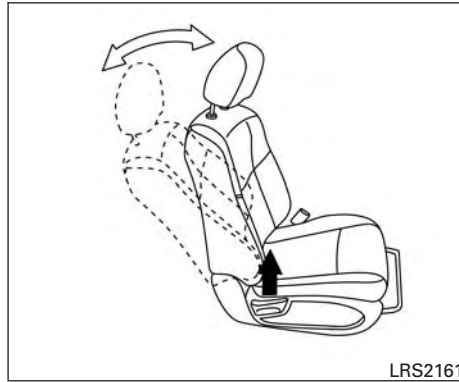

### Reclining

To recline the seatback, pull the lever up and lean back. To bring the seatback forward, pull the lever up and lean your body forward. Release the lever to lock the seatback in position.

The reclining feature allows adjustment of the seatback for occupants of different sizes for added comfort and to help obtain proper seat belt fit. See "Precautions on seat belt usage" in this section. Also, the seatback can be reclined to allow occupants to rest when the vehicle is stopped and the shift lever is in the P (Park) position.

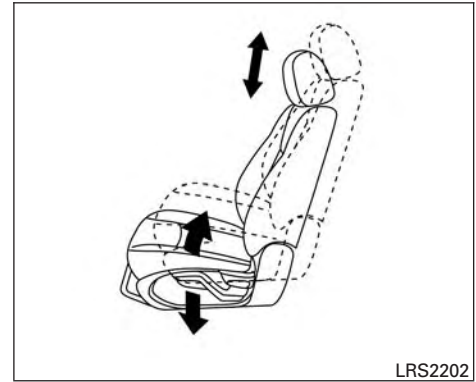

### Seat lifter (if so equipped for driver's seat)

Pull up or push down the adjusting lever to adjust the seat height until the desired position is achieved.

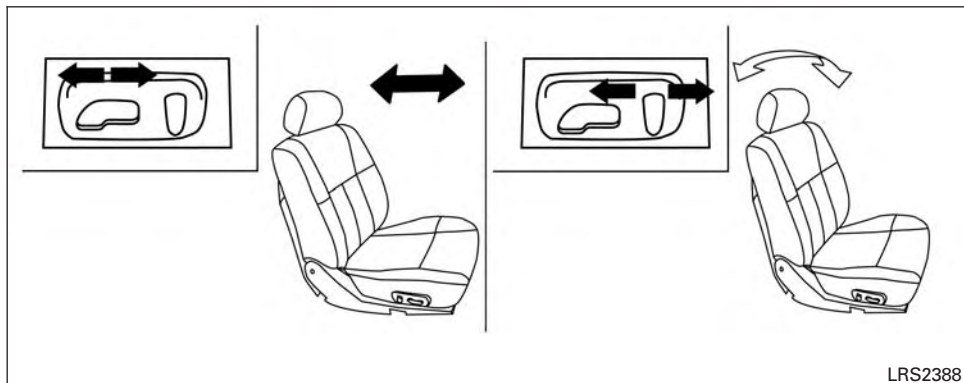

## FRONT POWER SEAT ADJUSTMENT (if so equipped)

### Operating tips

- The power seat motor has an auto-reset overload protection circuit. If the motor stops during operation, wait 30 seconds then reactivate the switch.

- Do not operate the power seat switch for a long period of time when the engine is off. This will discharge the battery.

### Forward and backward

Moving the switch forward or backward will slide the seat forward or backward to the desired position.

## Reclining

Move the recline switch backward until the desired angle is obtained. To bring the seatback forward again, move the switch forward and move your body forward. The seatback will move forward.

The reclining feature allows adjustment of the seatback for occupants of different sizes for added comfort and to help obtain proper seat belt fit. See "Precautions on seat belt usage" in this section. Also, the seatback can be reclined to allow occupants to rest when the vehicle is stopped and the shift lever is in P (Park).

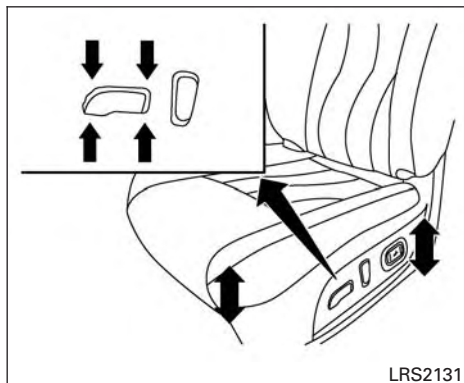

### Seat lifter (driver's seat)

Push the switch up or down to achieve desired seat height.

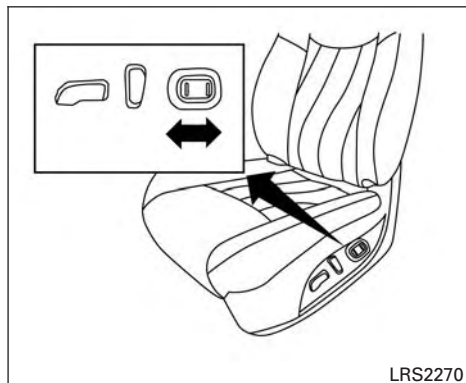

### Lumbar support (driver's seat)

The lumbar support feature provides adjustable lower back support to the driver. Move the switch forward or backward to adjust the seatback lumbar area.

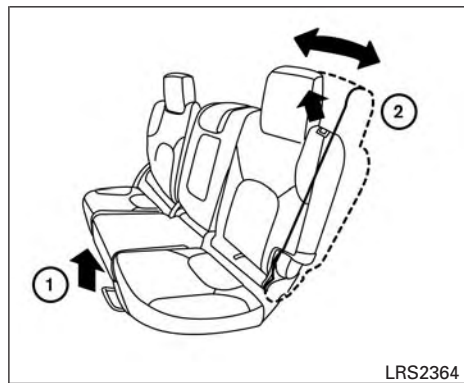

### Outboard seats

### 2ND ROW BENCH SEAT ADJUSTMENT

#### Forward and backward

Pull the center of the bar ① up and hold it while you slide the seat forward or backward to the desired position. Release the bar to lock the seat in position.

#### Reclining

To recline the seatback, pull up on the lever ② and lean back. To bring the seatback forward, pull the lever ② up and lean your body forward. Release the lever to lock the seatback in position.

The recline feature allows adjustment of the seatback for occupants of different sizes for added comfort and to help obtain proper seat belt fit. See "Precautions on seat belt usage" later in this section. Also, the seatback can be reclined to allow occupants to rest when the vehicle is stopped and the shift lever is in P (Park).

#### **⚠ WARNING**

- **After adjustment, gently rock in the seat to make sure it is securely locked.**
- **Do not ride in a moving vehicle when the seatback is reclined. This can be dangerous. The shoulder belt will not be against your body. In an accident, you could be thrown into it and receive neck or other serious injuries. You could also slide under the lap belt and receive serious internal injuries.**
- **For the most effective protection when the vehicle is in motion, the seat should be upright. Always sit well back in the seat and adjust the seat belt properly. See "Precautions on seat belt usage" later in this section.**

## HEAD RESTRAINTS/HEADRESTS

#### **⚠ WARNING**

**Head restraints/headrests supplement the other vehicle safety systems. They may provide additional protection against injury in certain rear end collisions. Adjustable head restraints/headrests must be adjusted properly, as specified in this section. Check the adjustment after someone else uses the seat. Do not attach anything to the head restraint/headrest stalks or remove the head restraint/headrest. Do not use the seat if the head restraint/headrest has been removed. If the head restraint/headrest was removed, reinstall and properly adjust the head restraint/headrest before an occupant uses the seating position. Failure to follow these instructions can reduce the effectiveness of the head restraints/headrests. This may increase the risk of serious injury or death in a collision.**

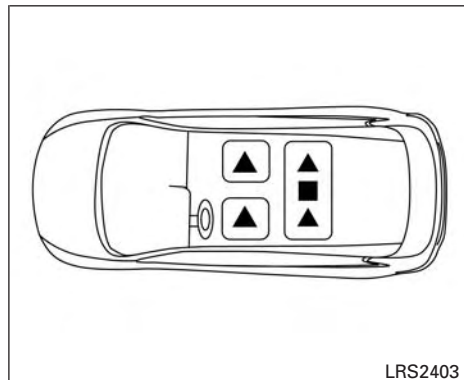

**2nd row seating**

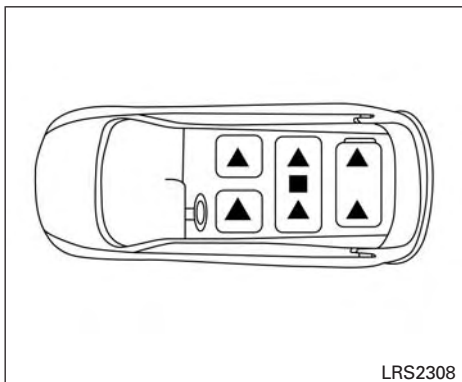

### 3rd row seating (if so equipped)

The illustration shows the seating positions equipped with head restraints/headrests.

▲ Indicates the seating position is equipped with a head restraint.

■ Indicates the seating position is equipped with a headrest.

+ Indicates the seating position is not equipped with a head restraint or headrest (if applicable).

- Your vehicle is equipped with a head restraint/headrest that may be integrated, adjustable or non-adjustable.

- Adjustable head restraints/headrests have multiple notches along the stalks to lock them in a desired adjustment position.
- The non-adjustable head restraints/headrests have a single locking notch to secure them to the seat frame.
- Proper Adjustment:
  - For the adjustable type, align the head restraint/headrest so the center of your ear is approximately level with the center of the head restraint/headrest.
  - If your ear position is still higher than the recommended alignment, place the head restraint/headrest at the highest position.
- If the head restraint/headrest has been removed, ensure that it is reinstalled and locked in place before riding in that designated seating position.

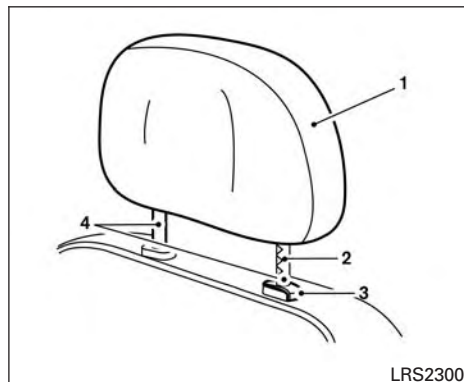

### Adjustable head restraint/headrest components

1. Removable head restraint/headrest
2. Multiple notches
3. Lock knob
4. Stalks



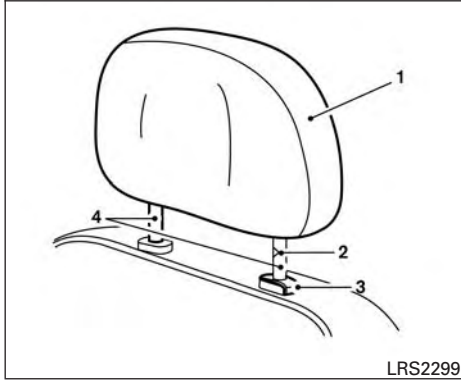

### Non-adjustable head restraint/ headrest components

1. Removable head restraint/headrest
2. Single Notch
3. Lock knob
4. Stalks

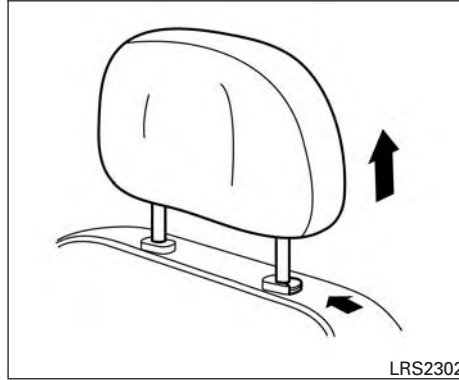

### Remove

Use the following procedure to remove the head restraint/headrest.

1. Pull the head restraint/headrest up to the highest position.
2. Push and hold the lock knob.
3. Remove the head restraint/headrest from the seat.
4. Store the head restraint/headrest properly in a secure place so it is not loose in the vehicle.

5. Reinstall and properly adjust the head restraint/headrest before an occupant uses the seating position.

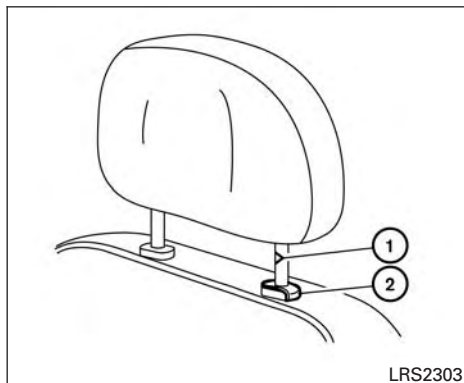

## Install

1. Align the head restraint/headrest stalks with the holes in the seat. Make sure the head restraint/headrest is facing the correct direction. The stalk with the notch (notches) ① must be installed in the hole with the lock knob ②.
2. Push and hold the lock knob and push the head restraint/headrest down.
3. Properly adjust the head restraint/headrest before an occupant uses the seating position.

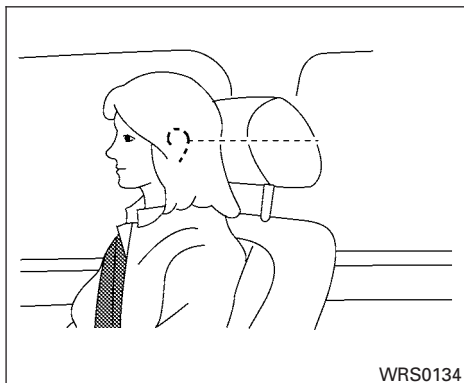

## Adjust

For adjustable head restraint/headrest

Adjust the head restraint/headrest so the center is level with the center of your ears. If your ear position is still higher than the recommended alignment, place the head restraint/headrest at the highest position.

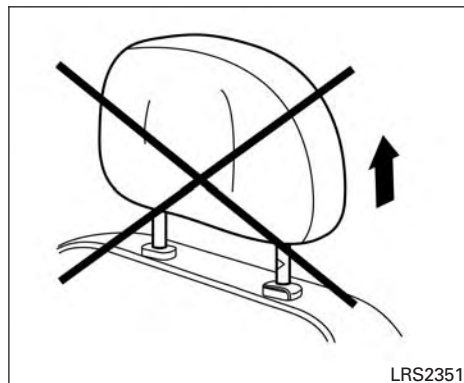

For non-adjustable head restraint/  
headrest

Make sure the head restraint/headrest is positioned so the lock knob is engaged in the notch before riding in that designated seating position.

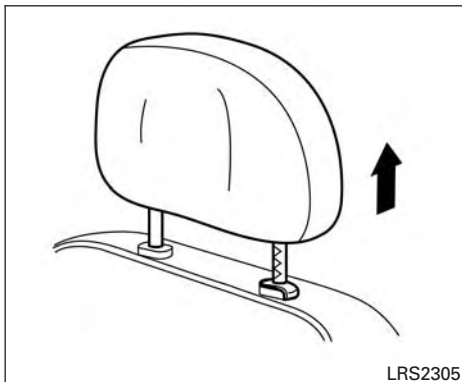

### Raise

To raise the head restraint/headrest, pull it up.

Make sure the head restraint/headrest is positioned so the lock knob is engaged in the notch before riding in that designated seating position.

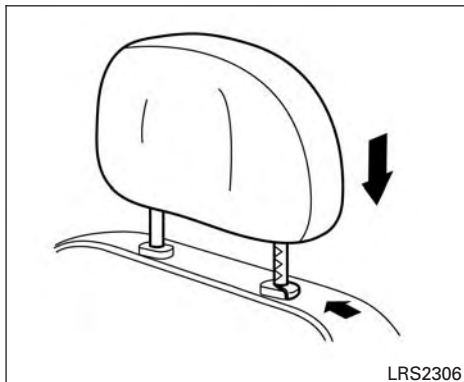

### Lower

To lower, push and hold the lock knob and push the head restraint/headrest down.

Make sure the head restraint/headrest is positioned so the lock knob is engaged in the notch before riding in that designated seating position.

## FLEXIBLE SEATING

### **⚠ WARNING**

- **Never allow anyone to ride in the cargo area or on the rear seats when they are in the fold-down position. In a collision, people riding in these areas without proper restraints are more likely to be seriously injured or killed.**
- **Do not allow people to ride in any area of your vehicle that is not equipped with seats and seat belts. Be sure everyone in your vehicle is in a seat and using a seat belt properly.**
- **Do not fold down the rear seats when occupants are in the rear seat area or any luggage is on the rear seats.**
- **Head restraints/headrests should be adjusted properly as they may provide significant protection against injury in an accident. Always replace and adjust them properly if they have been removed for any reason.**

- If the head restraints/headrests are removed for any reason, they should be securely stored to prevent them from causing injury to passengers or damage to the vehicle in case of sudden braking or an accident.
- When returning the seatbacks to the upright position, be certain they are completely secured in the latched position. If they are not completely secured, passengers may be injured in an accident or sudden stop.
- Properly secure all cargo to help prevent it from sliding or shifting. Do not place cargo higher than the seatbacks. In a sudden stop or collision, unsecured cargo could cause personal injury.

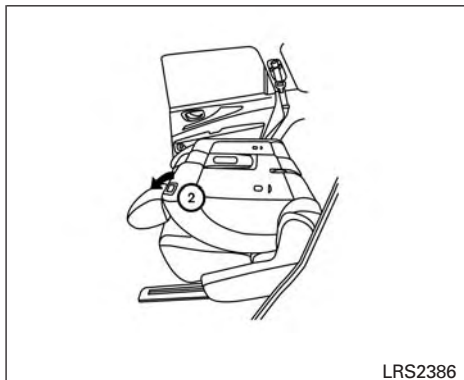

**For vehicles not equipped with 3rd row seating**

### Folding the 2nd row bench seat

To fold the 2nd row bench seat flat for maximum cargo hauling:

1. Make sure that the head restraints/headrests are lowered. For maximum cargo hauling, remove the center head restraint/headrest. To remove the head restraints/headrests, push and hold the lock knob while moving the head restraint/headrest in an upward direction. Store the head restraints/headrests properly so they are not loose in the vehicle.

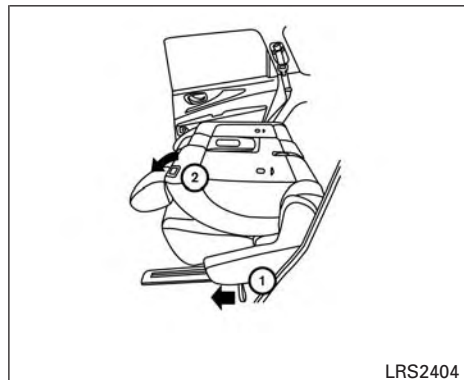

**For vehicles equipped with 3rd row seating**

2. Stow the 2nd row seat belts in the seat belt hooks found on the sides of the vehicle.
3. For vehicles equipped with 3rd row seating, pull the strap ① on the lower side of the outboard seats and lift up on the recline lever ② located on the top of the outboard seats to fold the seatbacks flat. For vehicles not equipped with 3rd row seating, lift up on the recline lever ② on the top of the outboard seats to fold the seatbacks flat.
4. To return the 2nd row bench seats to a seating position, push up on the seatback until it latches in place.

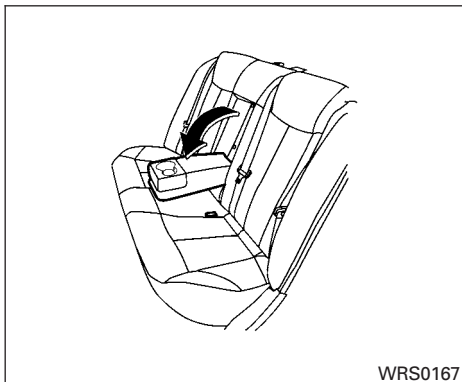

### Center armrest

Pull the armrest down until it rests on the seat cushion.

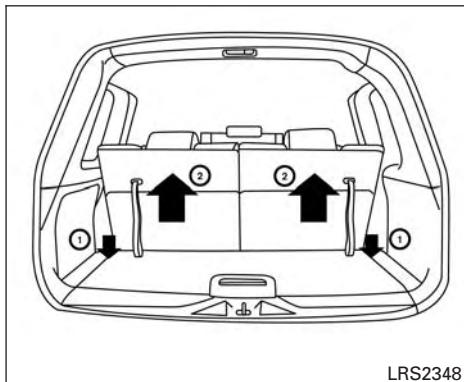

### Folding the 3rd row seats (If so equipped)

To fold the 3rd row seats flat for maximum cargo capacity:

1. Make sure the head restraints/headrests are all the way down.
2. Pull the strap ① to release the seat.
3. Once released, push the seatback forward ②.

To return the 3rd row seats to a seating position:

1. Use the pull straps ① to raise each seatback. Pull back until the seatback latches into position. **Make sure to properly raise each seatback to an upright and secured position.**

### **⚠ WARNING**

**When the seat is returned to the normal seating position, the head restraints/headrests must be returned to the upright position to properly protect vehicle occupants.**

## SEAT BELTS

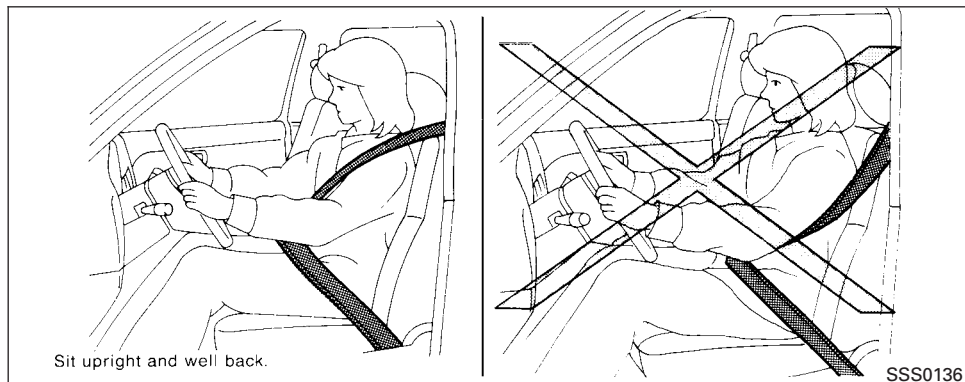

### PRECAUTIONS ON SEAT BELT USAGE

If you are wearing your seat belt properly adjusted and you are sitting upright and well back in your seat with both feet on the floor, your chances of being injured or killed in an accident and/or the severity of injury may be greatly reduced. NISSAN strongly encourages you and all of your passengers to buckle up every time you drive, even if your seating position includes a supplemental air bag.

**Most U.S. states and Canadian provinces or territories specify that seat belts be worn at all times when a vehicle is being driven.**

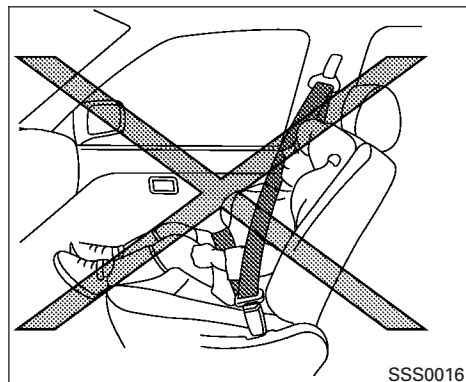
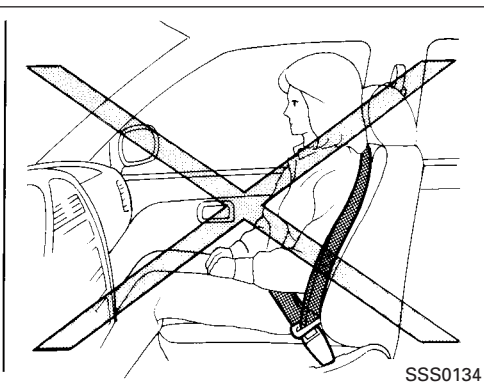
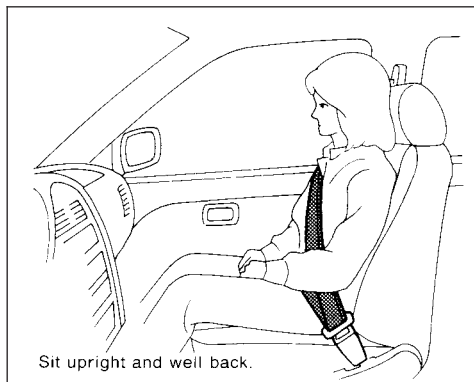

**⚠ WARNING**

- Every person who drives or rides in this vehicle should use a seat belt at all times. Children should be properly restrained in the rear seat and, if appropriate, in a child restraint.

**⚠ WARNING**

- The seat belt should be properly adjusted to a snug fit. Failure to do so may reduce the effectiveness of the entire restraint system and increase the chance or severity of injury in an accident. Serious injury or death can occur if the seat belt is not worn properly.

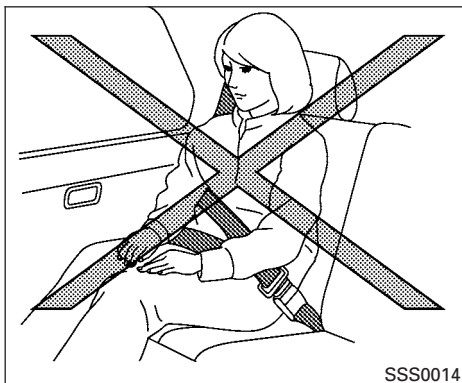

**⚠ WARNING**

- Always route the shoulder belt over your shoulder and across your chest. Never put the belt behind your back, under your arm or across your neck. The belt should be away from your face and neck, but not falling off your shoulder.
- Position the lap belt as low and snug as possible **AROUND THE HIPS, NOT THE WAIST**. A lap belt worn too high could increase the risk of internal injuries in an accident.

- Be sure the seat belt tongue is securely fastened to the proper buckle.
- Do not wear the seat belt inside out or twisted. Doing so may reduce its effectiveness.
- Do not allow more than one person to use the same seat belt.
- Never carry more people in the vehicle than there are seat belts.
- If the seat belt warning light glows continuously while the ignition is turned ON with all doors closed and all seat belts fastened, it may indicate a malfunction in the system. Have the system checked by a NISSAN dealer.
- No changes should be made to the seat belt system. For example, do not modify the seat belt, add material, or install devices that may change the seat belt routing or tension. Doing so may affect the operation of the seat belt system. Modifying or tampering with the seat belt system may result in serious personal injury.

- Once a seat belt pretensioner has activated, it cannot be reused and must be replaced together with the retractor. See your NISSAN dealer.
- Removal and installation of pretensioner system components should be done by a NISSAN dealer.
- All seat belt assemblies, including retractors and attaching hardware, should be inspected after any collision by a NISSAN dealer. NISSAN recommends that all seat belt assemblies in use during a collision be replaced unless the collision was minor and the belts show no damage and continue to operate properly. Seat belt assemblies not in use during a collision should also be inspected and replaced if either damage or improper operation is noted.
- All child restraints and attaching hardware should be inspected after any collision. Always follow the restraint manufacturer's inspection instructions and replacement recommendations. The child restraints should be replaced if they are damaged.



## PREGNANT WOMEN

NISSAN recommends that pregnant women use seat belts. The seat belt should be worn snug and always position the lap belt as low as possible around the hips, not the waist. Place the shoulder belt over your shoulder and across your chest. Never run the lap/shoulder belt over your abdominal area. Contact your doctor for specific recommendations.

## INJURED PERSONS

NISSAN recommends that injured persons use seat belts. Check with your doctor for specific recommendations.

## THREE-POINT TYPE SEAT BELT WITH RETRACTOR

### WARNING

- **Every person who drives or rides in this vehicle should use a seat belt at all times.**

- **Do not ride in a moving vehicle when the seatback is reclined. This can be dangerous. The shoulder belt will not be against your body. In an accident, you could be thrown into it and receive neck or other serious injuries. You could also slide under the lap belt and receive serious internal injuries.**
- **For the most effective protection when the vehicle is in motion, the seat should be upright. Always sit well back in the seat with both feet on the floor and adjust the seat belt properly.**
- **Do not allow children to play with the seat belts. Most seating positions are equipped with Automatic Locking Retractor (ALR) mode seat belts. If the seat belt becomes wrapped around a child's neck with the ALR mode activated, the child can be seriously injured or killed if the seat belt retracts and becomes tight. This can occur even if the vehicle is parked. Unbuckle the seat belt to release the child. If the seat belt cannot be unbuckled or is already unbuckled, release the child by cutting the seat belt with a suitable tool (such as a knife or scissors) to release the seat belt.**

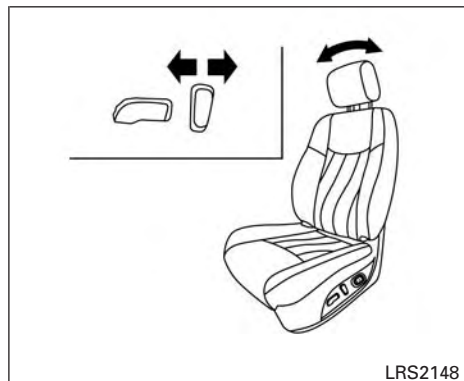

**Front seat shown**

### Fastening the seat belts

1. Adjust the seat. See “Seats” in this section.

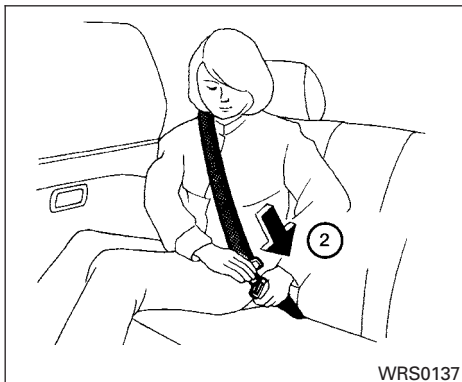

② Slowly pull the seat belt out of the retractor and insert the tongue into the buckle until you hear and feel the latch engage.

- **The retractor is designed to lock during a sudden stop or on impact. A slow pulling motion permits the seat belt to move and allows you some freedom of movement in the seat.**
- **If the seat belt cannot be pulled from its fully retracted position, firmly pull the belt and release it. Then smoothly pull the belt out of the retractor.**

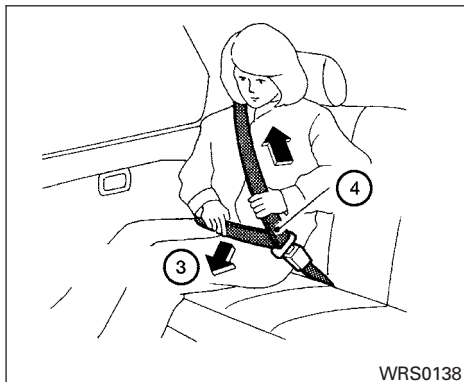

③ Position the lap belt portion **low and snug on the hips** as shown.

④ Pull the shoulder belt portion toward the retractor to take up extra slack. Be sure the shoulder belt is routed over your shoulder and across your chest.

The front passenger seat and the rear seating positions three-point seat belts have two modes of operation:

- Emergency Locking Retractor (ELR)
- Automatic Locking Retractor (ALR)

The Emergency Locking Retractor (ELR) mode allows the seat belt to extend and retract to allow the driver and passengers some freedom of movement in the seat. The ELR locks the seat belt when the vehicle slows down rapidly or during certain impacts.

The Automatic Locking Retractor (ALR) mode (child restraint mode) locks the seat belt for child restraint installation.

When the ALR mode is activated, the seat belt cannot be extended again until the seat belt tongue is detached from the buckle and fully retracted. The seat belt returns to the ELR mode after the seat belt fully retracts. See “Child restraints” in this section for more information.

**The ALR mode should be used only for child restraint installation. During normal seat belt use by an occupant, the ALR mode should not be activated. If it is activated, it may cause uncomfortable seat belt tension.**

#### **⚠ WARNING**

**When fastening the seat belts, be certain that the seatbacks are completely secured in the latched position. If they are not completely secured, passengers may be injured in an accident or sudden stop.**

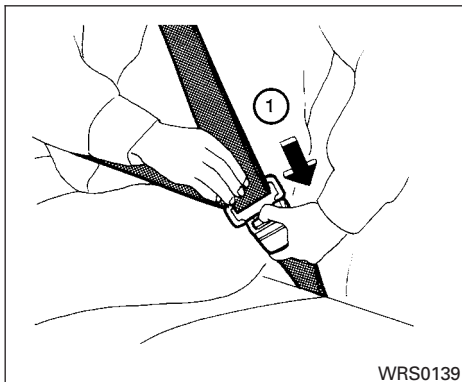

### Unfastening the seat belts

- ① To unfasten the seat belt, press the button on the buckle. The seat belt automatically retracts.

### Checking seat belt operation

Seat belt retractors are designed to lock seat belt movement by two separate methods:

- When the seat belt is pulled quickly from the retractor.
- When the vehicle slows down rapidly.

To increase your confidence in the seat belts, check the operation as follows:

- Grasp the shoulder belt and pull forward quickly. The retractor should lock and restrict further belt movement.

If the retractor does not lock during this check or if you have any questions about seat belt operation, see a NISSAN dealer.

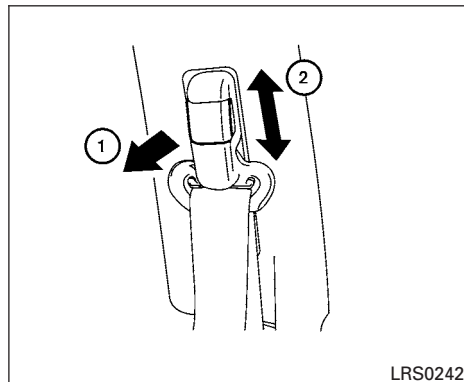

### Shoulder belt height adjustment (front seats)

The shoulder belt anchor height should be adjusted to the position best for you. See “Precautions on seat belt usage” in this section. To adjust, pull out the adjustment button ① and move the shoulder belt anchor to the desired position ②, so the belt passes over the center of the shoulder. The belt should be away from your face and neck, but not falling off your shoulder. Release the adjustment button to lock the shoulder belt anchor into position.

### **⚠ WARNING**

- After adjustment, release the adjustment button and try to move the shoulder belt anchor up and down to make sure it is securely fixed in position.
- The shoulder belt anchor height should be adjusted to the position best for you. Failure to do so may reduce the effectiveness of the entire restraint system and increase the chance or severity of injury in an accident.

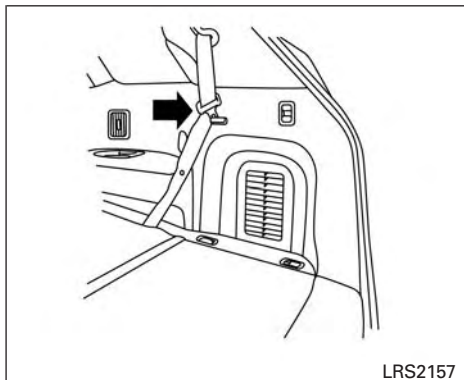

3rd row shown; 2nd row similar

### Seat belt hook

When the seat belt is not in use and when folding down the rear seats, hook the rear seat belts on the seat belt hooks.

### SEAT BELT EXTENDERS

If, because of body size or driving position, it is not possible to properly fit the lap/shoulder belt and fasten it, an extender that is compatible with the installed seat belts is available that can be purchased. The extender adds approximately 8 in (200 mm) of length and are available for the:

- Driver and front passenger seating position

- 2nd and 3rd row seating position

See a NISSAN dealer for assistance with purchasing an extender if an extender is required.

### **⚠ WARNING**

- **Only NISSAN seat belt extenders, made by the same company which made the original equipment seat belts, should be used with NISSAN seat belts.**
- **Adults and children who can use the standard seat belt should not use an extender. Such unnecessary use could result in serious personal injury in the event of an accident.**
- **Never use seat belt extenders to install child restraints. If the child restraint is not secured properly, the child could be seriously injured in a collision or a sudden stop.**

### SEAT BELT MAINTENANCE

- **To clean the seat belt webbing**, apply a mild soap solution or any solution recommended for cleaning upholstery or carpet. Then wipe with a cloth and allow the seat belts to dry in the shade. Do not allow the seat belts to retract until they are completely dry.

## CHILD SAFETY

- **If dirt builds up in the shoulder belt guide of the seat belt anchors**, the seat belts may retract slowly. Wipe the shoulder belt guide with a clean, dry cloth.
- **Periodically check to see that the seat belt and the metal components**, such as buckles, tongues, retractors, flexible wires and anchors, work properly. If loose parts, deterioration, cuts or other damage on the webbing is found, the entire seat belt assembly should be replaced.

### WARNING

**Do not allow children to play with the seat belts. Most seating positions are equipped with Automatic Locking Retractor (ALR) mode seat belts. If the seat belt becomes wrapped around a child's neck with the ALR mode activated, the child can be seriously injured or killed if the seat belt retracts and becomes tight. This can occur even if the vehicle is parked. Unbuckle the seat belt to release the child. If the seat belt cannot be unbuckled or is already unbuckled, release the child by cutting the seat belt with a suitable tool (such as a knife or scissors) to release the seat belt.**

**Children need adults to help protect them. They need to be properly restrained.**

In addition to the general information in this manual, child safety information is available from many other sources, including doctors, teachers, government traffic safety offices, and community organizations. Every child is different, so be sure to learn the best way to transport your child.

There are three basic types of child restraint systems:

- Rear-facing child restraint

- Forward-facing child restraint
- Booster seat

The proper restraint depends on the child's size. Generally, infants up to about 1 year and less than 20 lbs (9 kg) should be placed in rear-facing child restraints. Forward-facing child restraints are available for children who outgrow rear-facing child restraints and are at least 1 year old. Booster seats are used to help position a vehicle lap/shoulder belt on a child who can no longer use a forward-facing child restraint.

### WARNING

**Infants and children need special protection. The vehicle's seat belts may not fit them properly. The shoulder belt may come too close to the face or neck. The lap belt may not fit over their small hip bones. In an accident, an improperly fitting seat belt could cause serious or fatal injury. Always use appropriate child restraints.**

All U.S. states and Canadian provinces or territories require the use of approved child restraints for infants and small children. See "Child restraints" in this section.

A child restraint may be secured in the vehicle by using either the LATCH (Lower Anchors and Tethers for CHildren) system or with the vehicle seat belt. See “Child restraints” in this section for more information.

**NISSAN recommends that all pre-teens and children be restrained in the rear seat. Studies show that children are safer when properly restrained in the rear seat than in the front seat.**

**This is especially important because your vehicle has a supplemental restraint system (air bag system) for the front passenger. See “Supplemental restraint system” in this section.**

## INFANTS

Infants up to at least 1 year old should be placed in a rear-facing child restraint. NISSAN recommends that infants be placed in child restraints that comply with Federal Motor Vehicle Safety Standards or Canadian Motor Vehicle Safety Standards. You should choose a child restraint that fits your vehicle and always follow the manufacturer’s instructions for installation and use.

## SMALL CHILDREN

Children that are over 1 year old and weigh at least 20 lbs (9 kg) should remain in a rear-facing child restraint as long as possible up to the height or weight limit of the child restraint. Children who outgrow the height or weight limit of the rear-facing child restraint and are at least 1 year old should be secured in a forward-facing child restraint with a harness. Refer to the manufacturer’s instructions for minimum and maximum weight and height recommendations. NISSAN recommends that small children be placed in child restraints that comply with Federal Motor Vehicle Safety Standards or Canadian Motor Vehicle Safety Standards. You should choose a child restraint that fits your vehicle and always follow the manufacturer’s instructions for installation and use.

## LARGER CHILDREN

Children should remain in a forward-facing child restraint with a harness until they reach the maximum height or weight limit allowed by the child restraint manufacturer.

Once a child outgrows the height or weight limit of the harness-equipped forward-facing child restraint, NISSAN recommends that the child be placed in a commercially available booster seat to obtain proper seat belt fit. For a seat belt to fit properly, the booster seat should raise the child so that the shoulder belt is properly positioned across the chest and the top, middle portion of the shoulder. The shoulder belt should not cross the neck or face and should not fall off the shoulder. The lap belt should lie snugly across the lower hips or upper thighs, not the abdomen. A booster seat can only be used in seating positions that have a three-point type seat belt. The booster seat should fit the vehicle seat and have a label certifying that it complies with Federal Motor Vehicle Safety Standards or Canadian Motor Vehicle Safety Standards. Once the child has grown so the shoulder belt is no longer on or near the face and neck and the lap belt can be positioned properly across the lower hips or upper thighs, use the seat belt without the booster seat.

### **WARNING**

**Never let a child stand or kneel on any seat and do not allow a child in the cargo area. The child could be seriously injured or killed in a sudden stop or collision.**

## CHILD RESTRAINTS

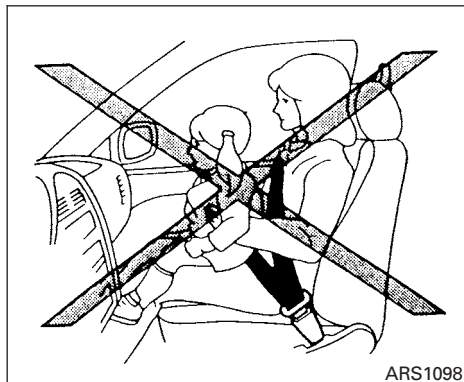

### PRECAUTIONS ON CHILD RESTRAINTS

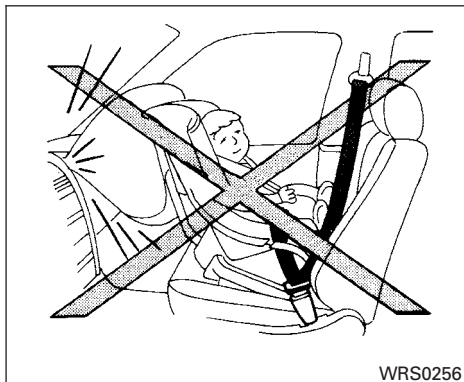

#### WARNING

- Failure to follow the warnings and instructions for proper use and installation of child restraints could result in serious injury or death of a child or other passengers in a sudden stop or collision:
  - The child restraint must be used and installed properly. Always follow all of the child restraint manufacturer's instructions for installation and use.

- Infants and children should never be held on anyone's lap. Even the strongest adult cannot resist the forces of a collision.
- Do not put a seat belt around both a child and another passenger.
- NISSAN recommends that all child restraints be installed in the rear seat. Studies show that children are safer when properly restrained in the rear seat than in the front seat. If you must install a forward-facing child restraint in the front seat, see "Forward-facing child restraint installation using the seat belts" in this section.
- Even with the NISSAN Advanced Air Bag System, never install a rear-facing child restraint in the front seat. An inflating air bag could seriously injure or kill a child. A rear-facing child restraint must only be used in the rear seat.
- Be sure to purchase a child restraint that will fit the child and vehicle. Some child restraints may not fit properly in your vehicle.

- **Child restraint anchor points are designed to withstand loads from child restraints that are properly fitted.**
- **Never use the anchor points for adult seat belts or harnesses.**
- **A child restraint with a top tether strap should not be used in the front passenger seat.**
- **Keep seatbacks as upright as possible after fitting the child restraint.**
- **Infants and children should always be placed in an appropriate child restraint while in the vehicle.**
- **When the child restraint is not in use, keep it secured with the LATCH system or a seat belt. In a sudden stop or collision, loose objects can injure occupants or damage the vehicle.**

 **CAUTION**

**A child restraint in a closed vehicle can become very hot. Check the seating surface and buckles before placing a child in the child restraint.**

This vehicle is equipped with a universal child restraint anchor system, referred to as the LATCH (Lower Anchors and Tethers for CHildren) system. Some child restraints include rigid or webbing-mounted attachments that can be connected to these anchors. For details, see “LATCH (Lower Anchors and Tethers for CHildren) system” in this section.

If you do not have a LATCH compatible child restraint, the vehicle seat belts can be used.

Several manufacturers offer child restraints for infants and children of various sizes. When selecting any child restraint, keep the following points in mind:

- Choose only a restraint with a label certifying that it complies with Federal Motor Vehicle Safety Standard 213 or Canadian Motor Vehicle Safety Standard 213.
- Check the child restraint in your vehicle to be sure it is compatible with the vehicle’s seat and seat belt system.

- If the child restraint is compatible with your vehicle, place your child in the child restraint and check the various adjustments to be sure the child restraint is compatible with your child. Choose a child restraint that is designed for your child’s height and weight. Always follow all recommended procedures.

**All U.S. states and Canadian provinces or territories require that infants and small children be restrained in an approved child restraint at all times while the vehicle is being operated. Canadian law requires the top tether strap on forward-facing child restraints be secured to the designated anchor point on the vehicle.**



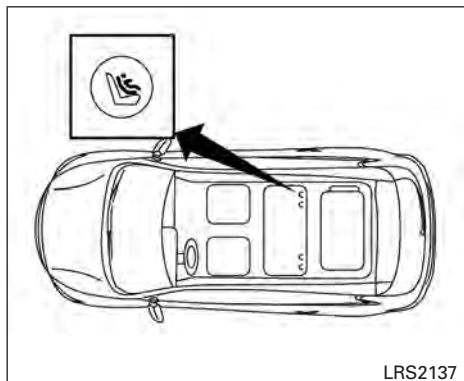

### LATCH system lower anchor locations - bench seat

## LATCH (Lower Anchors and Tethers for Children) SYSTEM

Your vehicle is equipped with special anchor points that are used with LATCH (Lower Anchors and Tethers for Children) system compatible child restraints. This system may also be referred to as the ISOFIX or ISOFIX compatible system. With this system, you do not have to use a vehicle seat belt to secure the child restraint.

The LATCH lower anchor points are provided to install child restraints in the following positions only:

- 2nd row bench seat – outboard seating positions

### LATCH lower anchor

#### **⚠ WARNING**

**Failure to follow the warnings and instructions for proper use and installation of child restraints could result in serious injury or death of a child or other passengers in a sudden stop or collision:**

- Attach LATCH system compatible child restraints only at the locations shown in the illustration.
- Do not secure a child restraint in the 2nd row center position using the LATCH system anchors. The child restraint will not be secured properly.

- Inspect the lower anchors by inserting your fingers into the lower anchor area. Feel to make sure there are no obstructions over the anchors such as seat belt webbing or seat cushion material. The child restraint will not be secured properly if the lower anchors are obstructed.
- Child restraint anchorages are designed to withstand only those loads imposed by correctly fitted child restraints. Under no circumstances are they to be used to attach adult seat belts, or other items or equipment to the vehicle. Doing so could damage the child restraint anchorages. The child restraint will not be properly installed using the damaged anchorages, and a child could be seriously injured or killed in a collision.

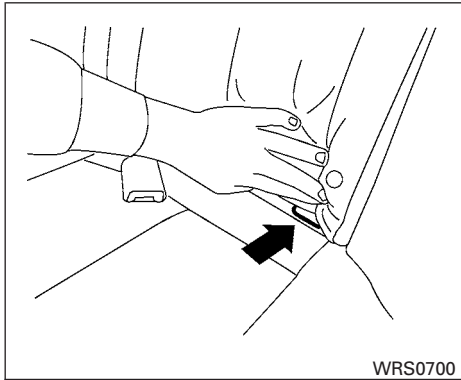

**LATCH lower anchor location**

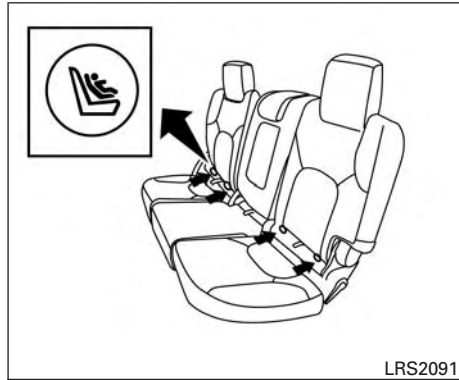

**LATCH label locations 2nd row bench**  
LATCH lower anchor locations

The LATCH lower anchors are located at the rear of the seat cushion near the seatback. A label is attached to the seatback to help you locate the LATCH lower anchors.

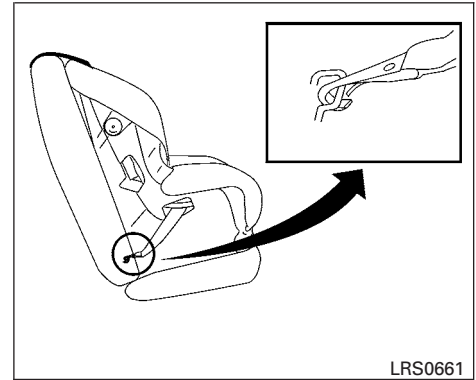

**LATCH webbing-mounted attachment**  
Installing child restraint LATCH lower anchor attachments

LATCH compatible child restraints include two rigid or webbing-mounted attachments that can be connected to two anchors located at certain seating positions in your vehicle. With this system, you do not have to use a vehicle seat belt to secure the child restraint. Check your child restraint for a label stating that it is compatible with LATCH. This information may also be in the instructions provided by the child restraint manufacturer.

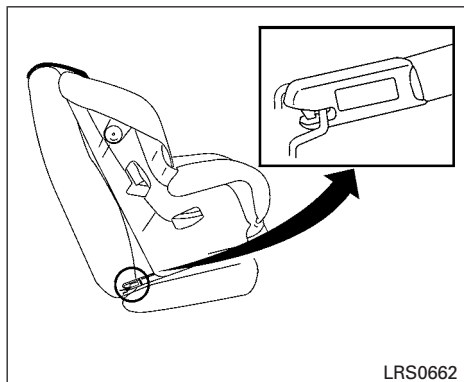

### LATCH rigid-mounted attachment

When installing a child restraint, carefully read and follow the instructions in this manual and those supplied with the child restraint.

### Top tether anchor

#### **⚠ WARNING**

- Do not allow cargo to contact the top tether strap when it is attached to the top tether anchor. Properly secure the cargo so it does not contact the top tether strap. Cargo that is not properly secured or cargo that contacts the top tether strap may damage it during a collision. A child could be seriously injured or killed in a collision if the top tether strap is damaged.
- Child restraint anchorages are designed to withstand only those loads imposed by correctly fitted child restraints. Under no circumstances are they to be used to attach adult seat belts, or other items or equipment to the vehicle. Doing so could damage the child restraint anchorages. The child restraint will not be properly installed using the damaged anchorages, and a child could be seriously injured or killed in a collision.

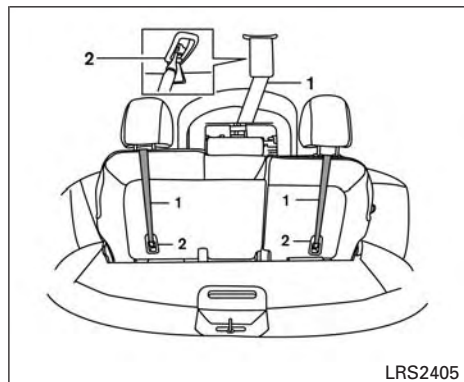

### 2nd row bench seat

1. Top tether strap
2. Anchor point

### Top tether anchor point locations

Anchor points are located in the following locations:

- 2nd row bench on the bottom of the seat-back in the seating positions shown.
- Roof above the rear cargo area or 3rd row bench seat (if so equipped).

- The top tether anchor located in the roof is only to be used for a child restraint located in the center position of the 2nd row.

A child restraint with a top tether strap should only be placed in the center position of the 2nd row if there are no 3rd row occupants.

Rearward adjustment of the 2nd row bench seat will result in loosening of the top tether strap for the center position of the 2nd row. Avoid moving the 2nd row bench seat or retighten the top tether strap following rearward movement of the 2nd row bench seat.

If you have any questions when installing a top tether strap, consult your NISSAN dealer for details.

## REAR-FACING CHILD RESTRAINT INSTALLATION USING LATCH

Refer to all Warnings and Cautions in the “Child Safety” and “Child Restraint” sections before installing a child restraint.

Follow these steps to install a rear-facing child restraint in the 2nd row seats using the LATCH system:

1. Position the child restraint on the seat. Always follow the child restraint manufacturer's instructions.

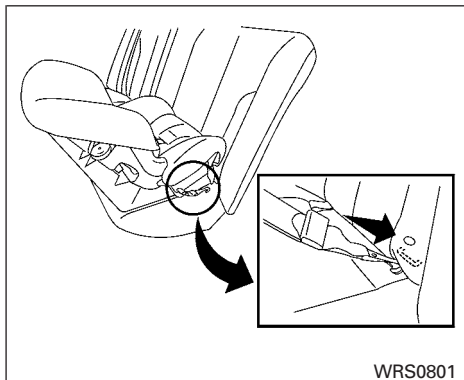

**Rear-facing web-mounted – step 2**

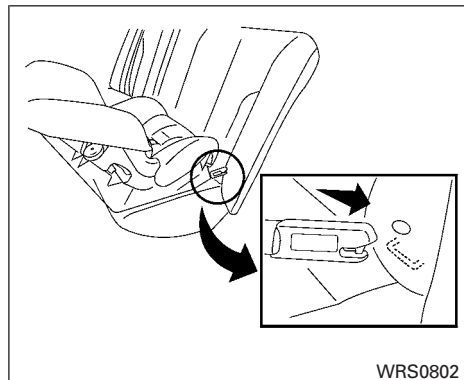

**Rear-facing rigid-mounted – step 2**

2. Secure the child restraint anchor attachments to the LATCH lower anchors. Check to make sure the LATCH attachment is properly attached to the lower anchors.

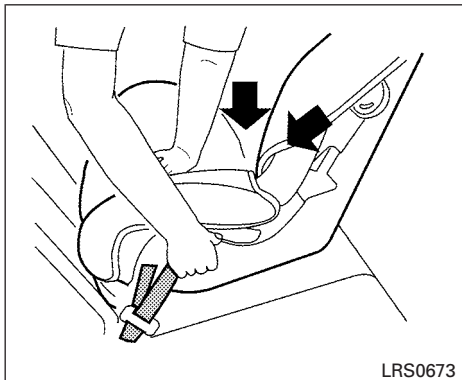

**Rear-facing – step 3**

3. For child restraints that are equipped with webbing-mounted attachments, remove any additional slack from the anchor attachments. Press downward and rearward firmly in the center of the child restraint with your hand to compress the vehicle seat cushion and seatback while tightening the webbing of the anchor attachments.

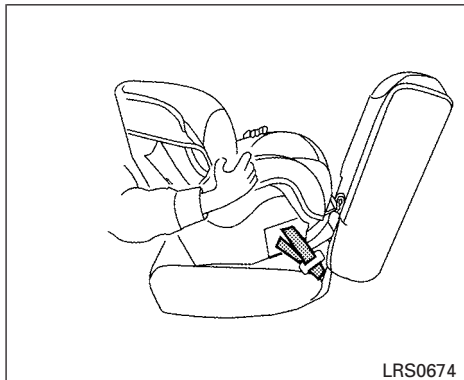

**Rear-facing – step 4**

4. After attaching the child restraint, test it before you place the child in it. Push it from side to side while holding the child restraint near the LATCH attachment path. The child restraint should not move more than 1 inch (25 mm), from side to side. Try to tug it forward and back and check to see if the LATCH attachment holds the restraint in place. If the restraint is not secure, tighten the LATCH attachment as necessary, or put the restraint in another seat and test it again. You may need to try a different child restraint or try installing by using the vehicle seat belt (if applicable). Not all child restraints fit in all types of vehicles.

5. Check to make sure the child restraint is properly secured prior to each use. If the child restraint is loose, repeat steps 2 through 4.

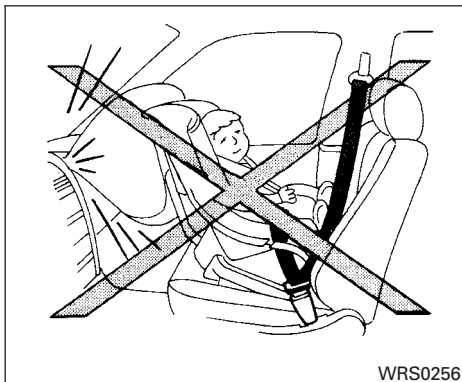

## REAR-FACING CHILD RESTRAINT INSTALLATION USING THE SEAT BELTS

### WARNING

The three-point seat belt with Automatic Locking Retractor (ALR) must be used when installing a child restraint. Failure to use the ALR mode will result in the child restraint not being properly secured. The restraint could tip over or be loose and cause injury to a child in a sudden stop or collision. Also, it can change the operation of the front passenger air bag. See “Supplemental air bag warning light” in this section.

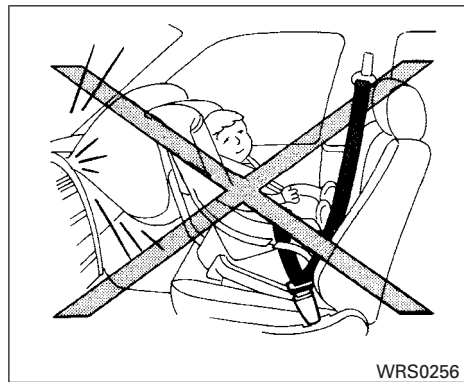

### Rear-facing – step 1

Refer to all Warnings and Cautions in the “Child safety” and “Child restraints” sections before installing a child restraint.

Follow these steps to install a rear-facing child restraint using the vehicle seat belts in the rear seats:

1. **Child restraints for infants must be used in the rear-facing direction and therefore must not be used in the front seat.** Position the child restraint on the seat. Always follow the restraint manufacturer’s instructions.

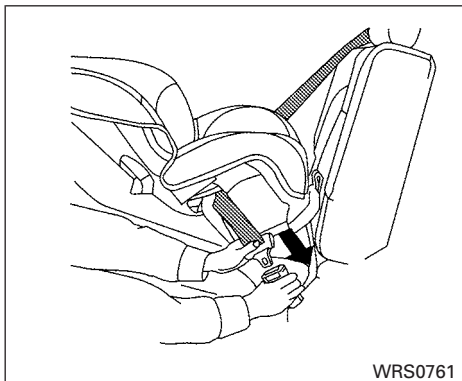

#### Rear-facing – step 2

2. Route the seat belt tongue through the child restraint and insert it into the buckle until you hear and feel the latch engage. Be sure to follow the child restraint manufacturer's instructions for belt routing.

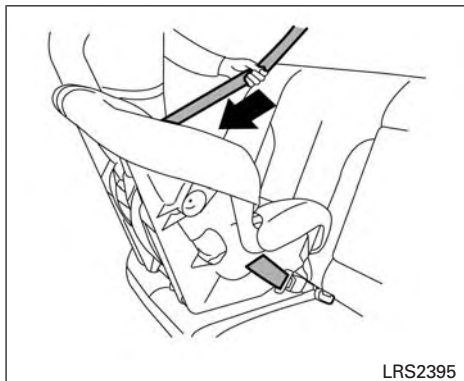

#### Rear-facing – step 3

3. Pull the shoulder belt until the belt is fully extended. At this time, the seat belt retractor is in the Automatic Locking Retractor (ALR) mode (child restraint mode). It reverts to the Emergency Locking Retractor (ELR) mode when the seat belt is fully retracted.

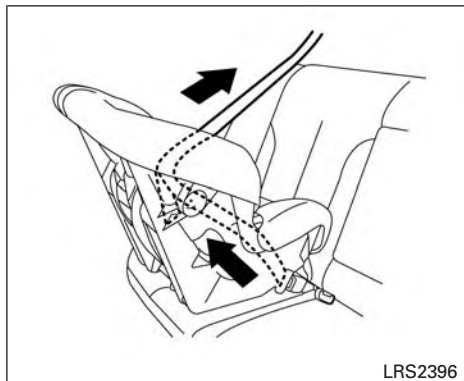

#### Rear-facing – step 4

4. Allow the seat belt to retract. Pull up on the shoulder belt to remove any slack in the belt.

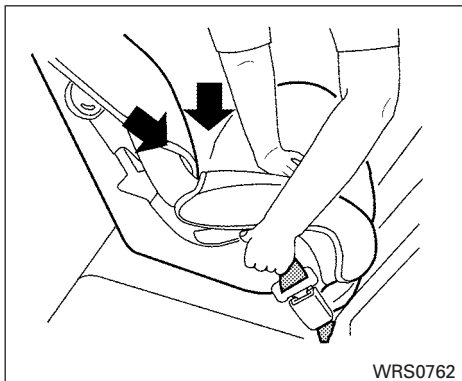

#### Rear-facing – step 5

5. Remove any additional slack from the seat belt; press downward and rearward firmly in the center of the child restraint to compress the vehicle seat cushion and seatback while pulling up on the seat belt.

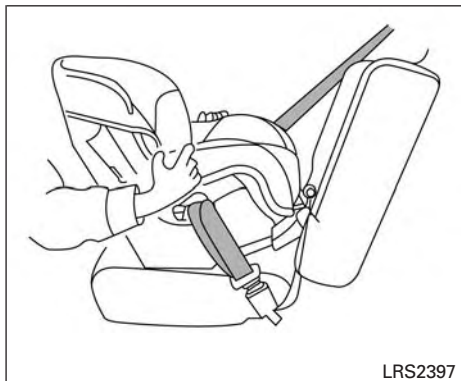

#### Rear-facing – step 6

6. After attaching the child restraint, test it before you place the child in it. Push it from side to side while holding the child restraint near the seat belt path. The child restraint should not move more than 1 inch (25 mm), from side to side. Try to tug it forward and check to see if the belt holds the restraint in place. If the restraint is not secure, tighten the seat belt as necessary, or put the restraint in another seat and test it again. You may need to try a different child restraint. Not all child restraints fit in all types of vehicles.

7. Check to make sure that the child restraint is properly secured prior to each use. If the seat belt is not locked, repeat steps 1 through 6.

After the child restraint is removed and the seat belt fully retracted, the ALR mode (child restraint mode) is canceled.

### FORWARD-FACING CHILD RESTRAINT INSTALLATION USING LATCH

Refer to all Warnings and Cautions in the “Child Safety” and “Child Restraints” sections before installing a child restraint.

Follow these steps to install a forward-facing child restraint in the 2nd row seats using the LATCH system:

1. Position the child restraint on the seat. Always follow the child restraint manufacturer's instructions.



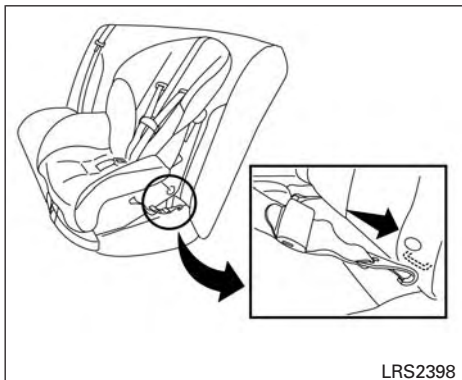

LRS2398

### Forward-facing web-mounted – step 2

2. Secure the child restraint anchor attachments to the LATCH lower anchors. Check to make sure the LATCH attachment is properly attached to the lower anchors.

If the child restraint is equipped with a top tether strap, route the top tether strap and secure the tether strap to the tether anchor point. See “Installing top tether strap” in this section. Do not install child restraints that require the use of a top tether strap in seating positions that do not have a top tether anchor.

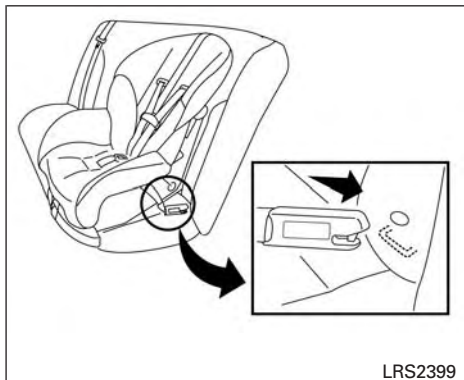

LRS2399

### Forward-facing rigid-mounted – step 2

3. The back of the child restraint should be secured against the vehicle seatback.

If necessary, adjust or remove the head restraint/headrest to obtain the correct child restraint fit. If the head restraint/headrest is removed, store it in a secure place. **Be sure to reinstall the head restraint/headrest when the child restraint is removed.** See “Head restraints/headrests” in this section for head restraint/headrest adjustment information.

If the seating position does not have an adjustable head restraint/headrest and it is interfering with the proper child restraint fit, try another seating position or a different child restraint.

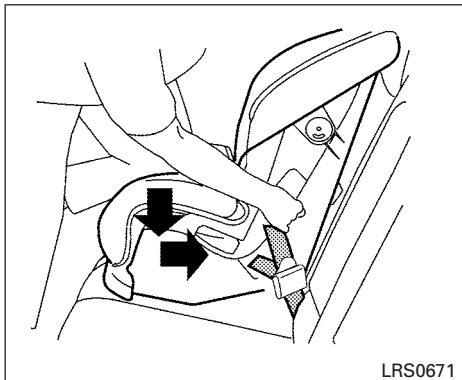

**Forward-facing – step 4**

- For child restraints that are equipped with webbing-mounted attachments, remove any additional slack from the anchor attachments. Press downward and rearward firmly in the center of the child restraint with your knee to compress the vehicle seat cushion and seatback while tightening the webbing of the anchor attachments.
- Tighten the tether strap according to the manufacturer's instructions to remove any slack.

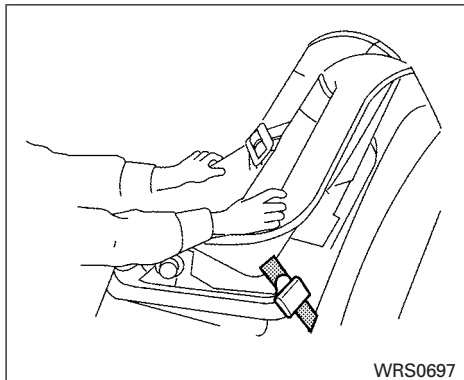

**Forward-facing – step 6**

- After attaching the child restraint, test it before you place the child in it. Push it from side to side while holding the child restraint near the LATCH attachment path. The child restraint should not move more than 1 inch (25 mm), from side to side. Try to tug it forward and check to see if the LATCH attachment holds the restraint in place. If the restraint is not secure, tighten the LATCH attachment as necessary, or put the restraint in another seat and test it again. You may need to try a different child restraint. Not all child restraints fit in all types of vehicles.

- Check to make sure the child restraint is properly secured prior to each use. If the child restraint is loose, repeat steps 3 through 6.

## FORWARD-FACING CHILD RESTRAINT INSTALLATION USING THE SEAT BELTS

### **⚠ WARNING**

The three-point seat belt with Automatic Locking Retractor (ALR) must be used when installing a child restraint. Failure to use the ALR mode will result in the child restraint not being properly secured. The restraint could tip over or be loose and cause injury to a child in a sudden stop or collision. Also, it can change the operation of the front passenger air bag. See “Front passenger air bag and status light” in this section.

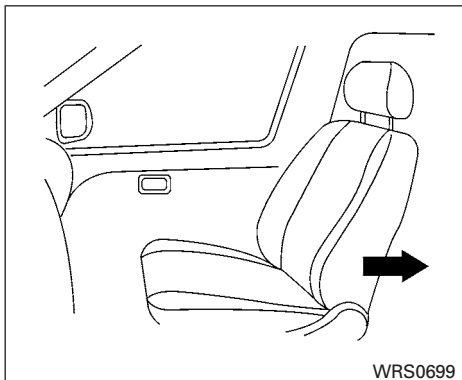

### Forward-facing (front passenger seat) – step 1

Refer to all Warnings and Cautions in the “Child Safety” and “Child Restraint” sections before installing a child restraint.

Follow these steps to install a forward-facing child restraint using the vehicle seat belt in the rear seats or in the front passenger seat:

1. **If you must install a child restraint in the front seat, it should be placed in a forward-facing direction only. Move the seat to the rearmost position. Child restraints for infants must be used in**

**the rear-facing direction and, therefore, must not be used in the front seat.**

2. Position the child restraint on the seat. Always follow the child restraint manufacturer's instructions.

The back of the child restraint should be secured against the vehicle seatback.

If necessary, adjust or remove the head restraint/headrest to obtain the correct child restraint fit. If the head restraint/headrest is removed, store it in a secure place. **Be sure to reinstall the head restraint/headrest when the child restraint is removed.** See “Head restraints/headrests” in this section for head restraint/headrest adjustment, removal and installation information.

If the seating position does not have an adjustable head restraint/headrest and it is interfering with the proper child restraint fit, try another seating position or a different child restraint.

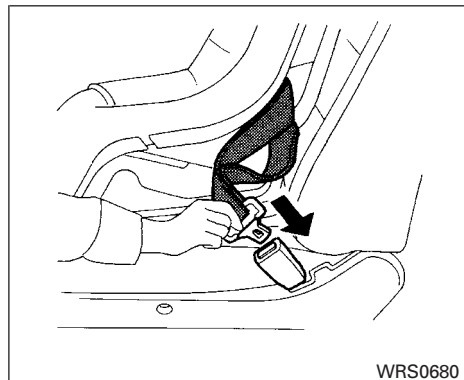

### Forward-facing – step 3

3. Route the seat belt tongue through the child restraint and insert it into the buckle until you hear and feel the latch engage. Be sure to follow the child restraint manufacturer's instructions for belt routing.

If the child restraint is equipped with a top tether strap, route the top tether strap and secure the tether strap to the tether anchor point (2nd row installation only). See “Installing top tether strap” in this section. Do not install child restraints that require the use of a top tether strap in seating positions that do not have a top tether anchor.

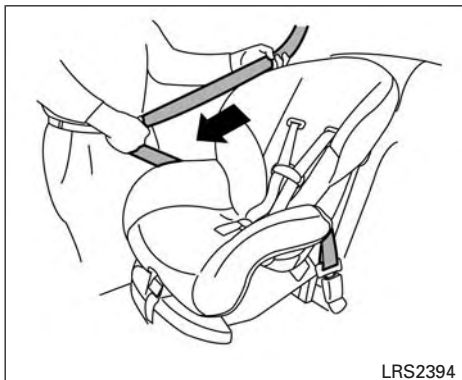

#### Forward-facing – step 4

4. Pull the shoulder belt until the belt is fully extended. At this time, the seat belt retractor is in the Automatic Locking Retractor (ALR) mode (child restraint mode). It reverts to Emergency Locking Retractor (ELR) mode when the seat belt is fully retracted.

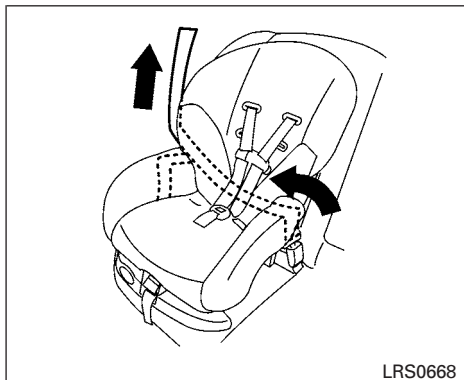

#### Forward-facing – step 5

5. Allow the seat belt to retract. Pull up on the shoulder belt to remove any slack in the belt.

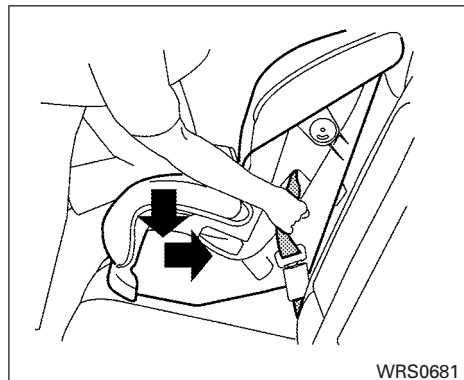

#### Forward-facing – step 6

6. Remove any additional slack from the seat belt; press downward and rearward firmly in the center of the child restraint with your knee to compress the vehicle seat cushion and seatback while pulling up on the seat belt.
7. Tighten the tether strap according to the manufacturer's instructions to remove any slack.



#### Forward-facing – step 8

8. After attaching the child restraint, test it before you place the child in it. Push it from side to side while holding the child restraint near the seat belt path. The child restraint should not move more than 1 inch (25 mm), from side to side. Try to tug it forward and check to see if the belt holds the restraint in place. If the restraint is not secure, tighten the seat belt as necessary, or put the restraint in another seat and test it again. You may need to try a different child restraint. Not all child restraints fit in all types of vehicles.

9. Check to make sure the child restraint is properly secured prior to each use. If the seat belt is not locked, repeat steps 2 through 8.



#### Forward-facing – step 10

10. If the child restraint is installed in the front passenger seat, place the ignition switch in the ON position. The front passenger air bag status light  should illuminate. If this light is not illuminated see “Front passenger air bag and status light” in this section. **Move the child restraint to another seating position.** Have the system checked by a NISSAN dealer.

After the child restraint is removed and the seat belt is fully retracted, the ALR mode (child restraint mode) is canceled.

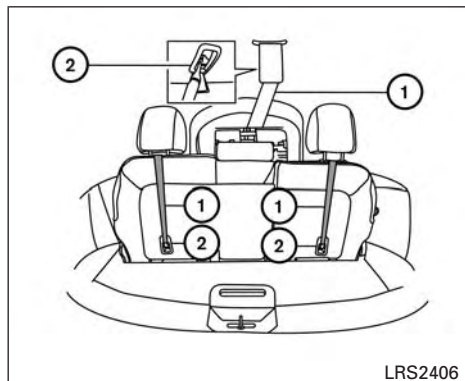

LRS2406

### 2nd row bench seat

1. Top tether strap ①
2. Anchor point ②

## INSTALLING TOP TETHER STRAP (2nd row bench seat)

### ⚠ WARNING

**Child restraint anchorages are designed to withstand only those loads imposed by correctly fitted child restraints. Under no circumstances are they to be used to attach adult seat belts, or other items or equipment to the vehicle. Doing so could damage the child restraint anchorages. The child restraint will not be properly installed using the damaged anchorages, and a child could be seriously injured or killed in a collision.**

First, secure the child restraint with the LATCH lower anchors (2nd row bench outboard seating positions only) or the seat belt, as applicable.

#### 1. OUTBOARD SEATING POSITIONS

If necessary, raise or remove the head restraint/headrest to position the top tether strap ① over the top of the seatback. If the head restraint/headrest is removed, store it in a secure place. Be sure to reinstall the head restraint/headrest when the child restraint is removed. **See “Head restraint/headrest adjustment” in this section for head restraint/headrest ad-**

**justment, removal and installation information.**

#### CENTER SEATING POSITION

Remove the head restraint/headrest and position the top tether strap ① over the seatback or adjust the head restraint/headrest to the lowest position and position the top tether strap over the head restraint/headrest. If the head restraint/headrest is removed, store it in a secure place. Be sure to reinstall the head restraint/headrest when the child restraint is removed. **See “Head restraint/headrest” in this section for head restraint/headrest adjustment, removal and installation information.**

2. Open the top tether anchor ② cover located on the ceiling.
3. Secure the tether strap ① to the tether anchor ② point on the ceiling behind the child restraint.
4. Tighten the tether strap according to the manufacturer's instructions to remove any slack. Make sure the head restraint/headrest does not contact the top tether strap.

A child restraint with a top tether strap should only be placed in the center position of the 2nd row if there are no 3rd row occupants.

Rearward adjustment of the 2nd row bench seat will result in loosening of the top tether strap for the center position of the 2nd row. Avoid moving the 2nd row bench seat or re-tighten the top tether strap following rearward movement of the 2nd row bench seat.

**If you have any questions when installing a top tether strap, consult your NISSAN dealer for details.**

## BOOSTER SEATS

Precautions on booster seats

### WARNING

**If a booster seat and seat belt are not used properly, the risk of a child being injured in a sudden stop or collision greatly increases:**

- **Make sure the shoulder portion of the belt is away from the child's face and neck and the lap portion of the belt does not cross the stomach.**
- **Make sure the shoulder belt is not behind the child or under the child's arm.**
- **A booster seat must only be installed in a seating position that has a lap/shoulder belt.**

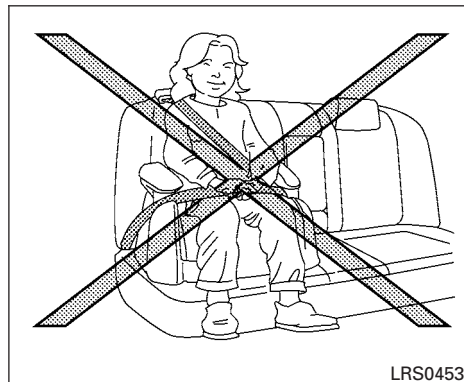
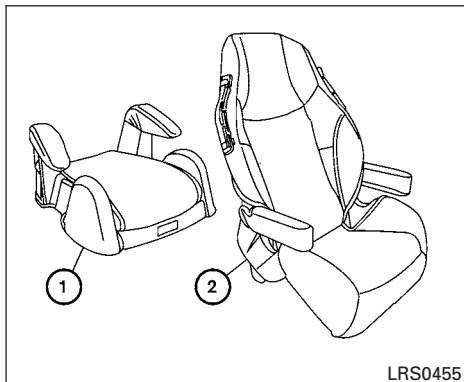

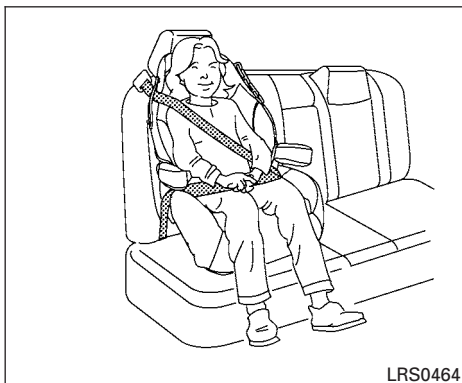

Booster seats of various sizes are offered by several manufacturers. When selecting any booster seat, keep the following points in mind:

- Choose only a booster seat with a label certifying that it complies with Federal Motor Vehicle Safety Standard 213 or Canadian Motor Vehicle Safety Standard 213.
- Check the booster seat in your vehicle to be sure it is compatible with the vehicle's seat and seat belt system.

- Make sure the child's head will be properly supported by the booster seat or vehicle seat. The seatback must be at or above the center of the child's ears. For example, if a low back booster seat ① is chosen, the vehicle seatback must be at or above the center of the child's ears. If the seatback is lower than the center of the child's ears, a high back booster seat ② should be used.
- If the booster seat is compatible with your vehicle, place the child in the booster seat and check the various adjustments to be sure the booster seat is compatible with the child. Always follow all recommended procedures.

**All U.S. states and Canadian provinces or territories require that infants and small children be restrained in an approved child restraint at all times while the vehicle is being operated.**

The instructions in this section apply to booster seat installation in the rear seats or the front passenger seat.

## Booster seat installation

### **⚠ CAUTION**

**Do not use the lap/shoulder belt in the Automatic Locking Retractor (ALR) mode when using a booster seat with the seat belts.**

Refer to all Warnings and Cautions in the "Child Safety," "Child Restraint" and "Booster Seats" sections before installing a child restraint.

Follow these steps to install a booster seat in the 2nd or 3rd rows or in the front passenger seat:



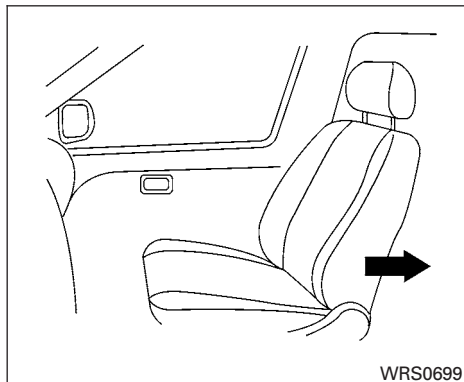

1. **If you must install a booster seat in the front seat, move the seat to the rear-most position.**
2. Position the booster seat on the seat. Only place it in a front-facing direction. Always follow the booster seat manufacturer's instructions.



#### Front passenger position

3. The booster seat should be positioned on the vehicle seat so that it is stable.  
  
If necessary, adjust or remove the head restraint/headrest to obtain the correct booster seat fit. If the head restraint/headrest is removed, store it in a secure place. **Be sure to reinstall the head restraint/headrest when the booster seat is removed.** See "Head restraints/headrests" in this section for head restraint/headrest adjustment, removal and installation information.

If the seating position does not have an adjustable head restraint/headrest and it is interfering with the proper booster seat fit, try another seating position or a different booster seat.

4. Position the lap portion of the seat belt low and snug on the child's hips. Be sure to follow the booster seat manufacturer's instructions for adjusting the seat belt routing.
5. Pull the shoulder belt portion of the seat belt toward the retractor to take up extra slack. Be sure the shoulder belt is positioned across the top, middle portion of the child's shoulder. Be sure to follow the booster seat manufacturer's instructions for adjusting the seat belt routing.
6. Follow the warnings, cautions and instructions for properly fastening a seat belt shown in "Three-point type seat belt with retractor" in this section.

## SUPPLEMENTAL RESTRAINT SYSTEM

### PRECAUTIONS ON SUPPLEMENTAL RESTRAINT SYSTEM

This Supplemental Restraint System (SRS) section contains important information concerning the following systems:

- Driver and passenger supplemental front-impact air bag (NISSAN Advanced Air Bag System)
- Front seat-mounted side-impact supplemental air bag
- Roof-mounted curtain side-impact and rollover supplemental air bag
- Seat belt with pretensioner

#### **Supplemental front-impact air bag system:**

The NISSAN Advanced Air Bag System can help cushion the impact force to the head and chest of the driver and front passenger in certain frontal collisions.

#### **Front seat-mounted side-impact supplemental air bag system:**

This system can help cushion the impact force to the chest area of the driver and front passenger in certain side-impact collisions. The side air bags are designed to inflate on the side where the vehicle is impacted.

#### **Roof-mounted curtain side-impact and rollover supplemental air bag system:**

This system can help cushion the impact force to the head of occupants in the outboard seating positions in certain side-impact or rollover collisions. In a side impact, the curtain air bags are designed to inflate on the side where the vehicle is impacted. In a rollover, curtain air bags on both sides are designed to inflate and remain inflated for a short time.

These supplemental restraint systems are designed to **supplement** the crash protection provided by the driver and front passenger seat belts and are **not a substitute** for them. Seat belts should always be correctly worn and the occupant seated a suitable distance away from the steering wheel, instrument panel and door finishers. See “Seat belts” in this section for instructions and precautions on seat belt usage.

**The supplemental air bags operate only when the ignition switch is placed in the ON position.**

**After placing the ignition switch in the ON position, the supplemental air bag warning light illuminates. The supplemental air bag warning light will turn off after about 7 seconds if the system is operational.**



7. If the booster seat is installed in the front passenger seat, place the ignition switch in the ON position. The front passenger air bag status light  may or may not illuminate, depending on the size of the child and the type of booster seat being used. See “Front passenger air bag and status light” in this section.

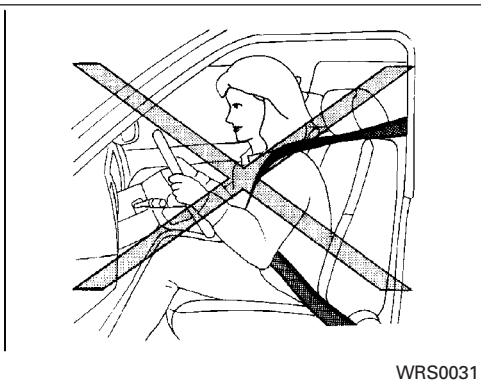
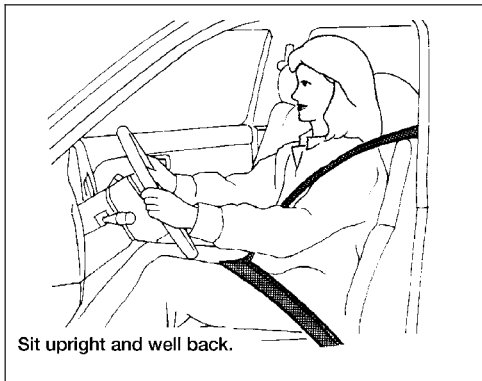

**⚠ WARNING**

- The front air bags ordinarily will not inflate in the event of a side impact, rear impact, rollover, or lower severity frontal collision. Always wear your seat belts to help reduce the risk or severity of injury in various kinds of accidents.
- The front passenger air bag will not inflate if the passenger air bag status light is lit or if the front passenger seat is unoccupied. See “Front passenger air bag and status light” later in this section.

- The seat belts and the front air bags are most effective when you are sitting well back and upright in the seat. The front air bags inflate with great force. Even with the NISSAN Advanced Air Bag System, if you are unrestrained, leaning forward, sitting sideways or out of position in any way, you are at greater risk of injury or death in a crash. You may also receive serious or fatal injuries from the front air bag if you are up against it when it inflates. Always sit back against the seatback and as far away as practical from the steering wheel or instrument panel. Always use the seat belts.

- The driver and front passenger seat belt buckles are equipped with sensors that detect if the seat belts are fastened. The Advanced Air Bag System monitors the severity of a collision and seat belt usage then inflates the air bags as needed. Failure to properly wear seat belts can increase the risk or severity of injury in an accident.
- The front passenger seat is equipped with an Occupant Classification Sensor (weight sensor) that turns the front passenger air bag OFF under some conditions. This sensor is only used in this seat. Failure to be properly seated and wearing the seat belt can increase the risk or severity of injury in an accident. See “Front passenger air bag and status light” in this section.
- Keep hands on the outside of the steering wheel. Placing them inside the steering wheel rim could increase the risk that they are injured when the front air bag inflates.

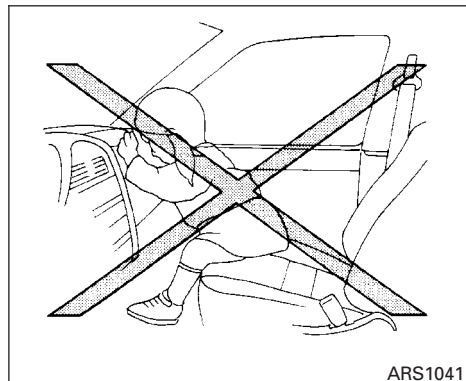
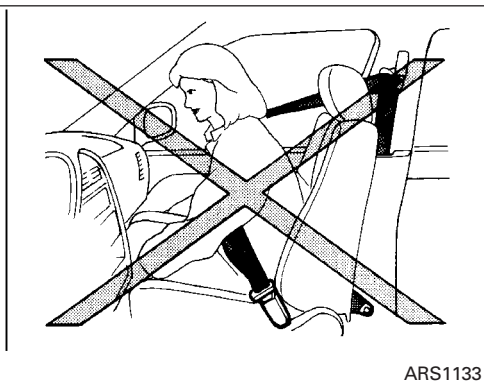

**⚠ WARNING**

- **Never let children ride unrestrained or extend their hands or face out of the window. Do not attempt to hold them in your lap or arms. Some examples of dangerous riding positions are shown in the illustrations.**

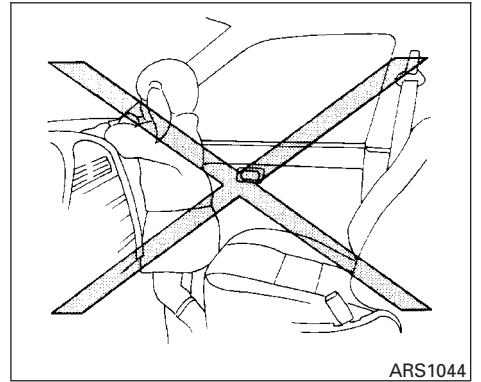
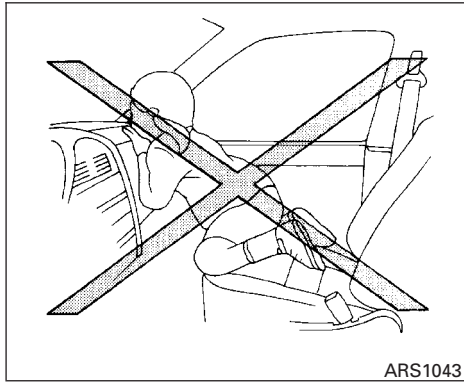
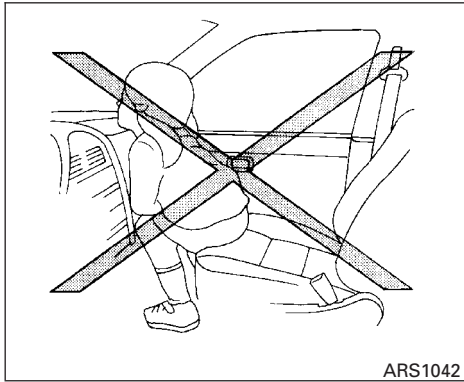

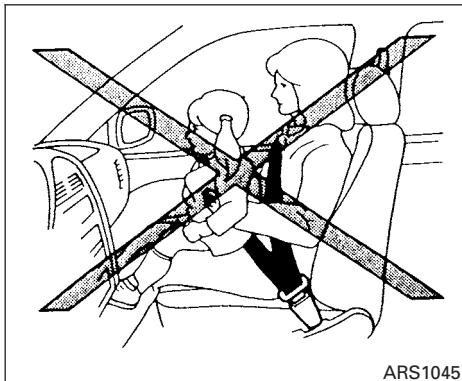

ARS1045

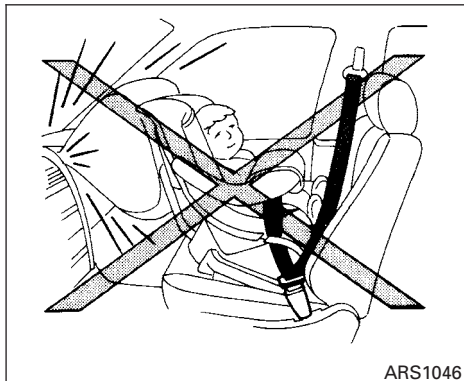

ARS1046

**⚠ WARNING**

- Children may be severely injured or killed when the front air bags, side air bags or curtain air bags or curtain air bags inflate if they are not properly restrained. Pre-teens and children should be properly restrained in the rear seat, if possible.
- Even with the NISSAN Advanced Air Bag System, never install a rear-facing child restraint in the front seat. An inflating front air bag could seriously injure or kill your child. See “Child restraints” in this section for details.

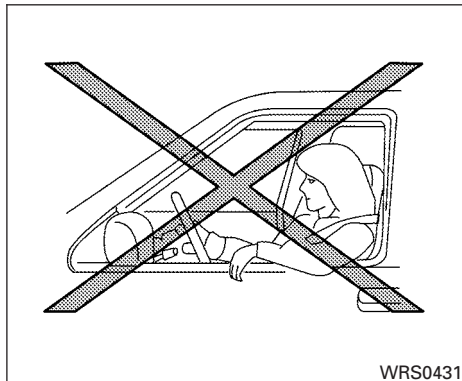

WRS0431

**⚠ WARNING**

Front seat-mounted side-impact supplemental air bags and roof-mounted curtain side-impact and rollover supplemental air bags:

- The side air bags and curtain air bags ordinarily will not inflate in the event of a frontal impact, rear impact, or lower severity side collision. Always wear your seat belts to help reduce the risk or severity of injury in various kinds of accidents.

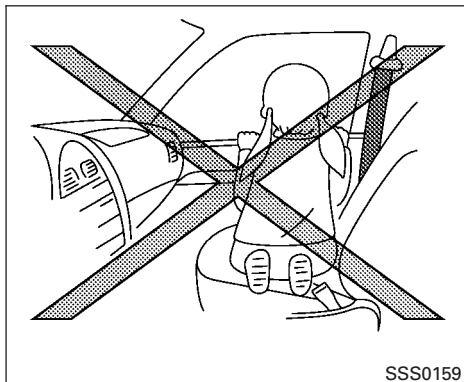
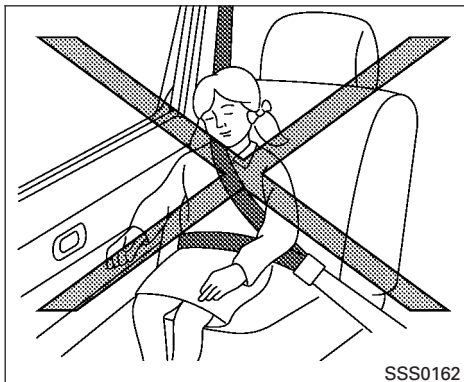

**⚠ WARNING**

- The seat belts, the side air bags and curtain air bags are most effective when you are sitting well back and upright in the seat with both feet on the floor. The side air bag and curtain air bag inflate with great force. Do not allow anyone to place their hand, leg or face near the side air bag on the side of the seatback of the front seat or near the side roof rails. Do not allow anyone sitting in the front seats or rear outboard seats to extend their hand out of the window or lean against the door. Some examples of dangerous riding positions are shown in the previous illustrations.

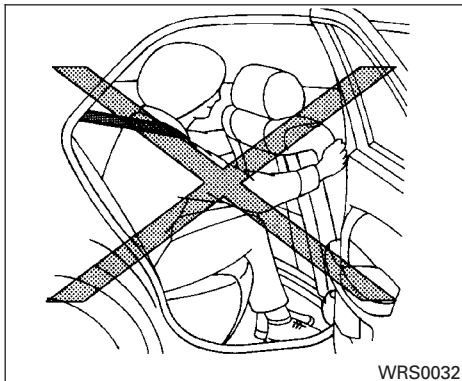

#### **⚠ WARNING**

- **When sitting in the 2nd row, do not hold onto the seatback of the front seat. If the side air bag inflates, you may be seriously injured. Be especially careful with children, who should always be properly restrained. Some examples of dangerous riding positions are shown in the illustrations**
- **Do not use seat covers on the front seatbacks. They may interfere with side air bag inflation.**



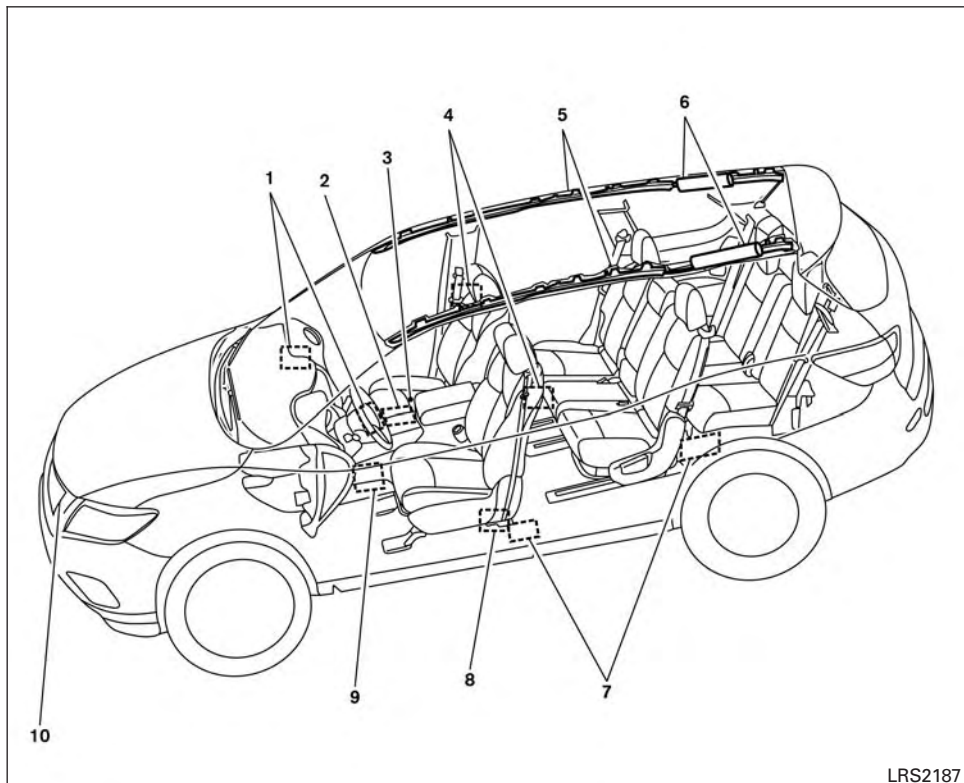

1. Supplemental front-impact air bag modules
2. Air bag Control Unit (ACU)
3. Occupant classification sensor (weight sensor)
4. Front seat-mounted side-impact supplemental air bag modules
5. Roof-mounted curtain side-impact and rollover supplemental air bags
6. Roof-mounted curtain side-impact and rollover supplemental air bag inflators
7. Satellite sensors
8. Seat belt with pretensioner
9. Pressure sensors in door (driver's side shown; passenger side similar)
10. Crash zone sensor

**NISSAN Advanced Air Bag System  
(front seats)**

**⚠ WARNING**

**To ensure proper operation of the passenger's advanced air bag system, please observe the following items.**

- **Do not allow a passenger in the rear seat to push or pull on the seatback pocket.**

LRS2187

- Do not place heavy loads heavier than 2.2 lb (1 kg) on the seatback, head restraint/headrest or in the seatback pocket.
- Do not store luggage behind the seat that can press into the seatback.
- Do not position the front passenger seat so it contacts the rear seat. If the front seat does contact the rear seat, the air bag system may determine a sensor malfunction has occurred and the front passenger air bag status light may illuminate and the supplemental air bag warning light may flash.
- If a forward-facing child restraint is installed in the front passenger seat, do not position the front passenger seat so the child restraint contacts the instrument panel. If the child restraint does contact the instrument panel, the system may determine the seat is occupied and the passenger air bag may deploy in a collision. Also the front passenger air bag status light may not illuminate. See “Child restraints” in this section for information about installing and using child restraints.

- Confirm the operating condition with the front passenger air bag status light.
- If you notice that the front passenger air bag status light is not operating as described in this section, please take your vehicle to your NISSAN dealer to check the occupant classification system.
- Until you have confirmed with your dealer that your passenger seat occupant classification system is working properly, position the occupants in the rear seating positions.

This vehicle is equipped with the NISSAN Advanced Air Bag System for the driver and front passenger seats. This system is designed to meet certification requirements under U.S. regulations. It is also permitted in Canada. **All of the information, cautions and warnings in this manual must be followed.**

The driver supplemental front-impact air bag is located in the center of the steering wheel. The passenger supplemental front-impact air bag is mounted in the dashboard above the glove box. The front air bags are designed to inflate in higher severity frontal collisions, although they may inflate if the forces in another type of collision are similar to those of a higher severity frontal impact. They may not inflate in certain frontal collisions.

Vehicle damage (or lack of it) is not always an indication of proper front air bag system operation.

The NISSAN Advanced Air Bag System has dual stage inflators. It also monitors information from the crash zone sensor and the Air bag Control Unit (ACU). Inflator operation is based on the severity of a collision and seat belt usage for the driver. For the front passenger, the occupant classification sensor is also monitored. Based on information from the sensor, only one front air bag may inflate in a crash, depending on the crash severity. Additionally, the front passenger air bag may be automatically turned OFF under some conditions, depending on the weight detected on the passenger seat and how the seat belt is used. If the front passenger air bag is OFF, the passenger air bag status light will be illuminated (if the seat is unoccupied, the light will not be illuminated, but the air bag will be off). See “Front passenger air bag and status light” in this section for further details. One front air bag inflating does not indicate improper performance of the system.

If you have any questions about your air bag system, please contact NISSAN or your NISSAN dealer. If you are considering modification of your vehicle due to a disability, you may also contact NISSAN. Contact information is contained in the front of this Owner's Manual.

When a front air bag inflates, a fairly loud noise may be heard, followed by the release of smoke. This smoke is not harmful and does not indicate a fire. Care should be taken to not inhale it, as it may cause irritation and choking. Those with a history of a breathing condition should get fresh air promptly.

Front air bags, along with the use of seat belts, help to cushion the impact force on the face and chest of the front occupants. They can help save lives and reduce serious injuries. However, an inflating front air bag may cause facial abrasions or other injuries. Front air bags do not provide restraint to the lower body.

Even with NISSAN advanced air bags, seat belts should be correctly worn and the driver and passenger seated upright as far as practical away from the steering wheel or instrument panel. The front air bags inflate quickly in order to help protect the front occupants. Because of this, the force of the front air bag inflating can increase the risk of injury if the occupant is too close to, or is against, the front air bag module during inflation.

The front air bags deflate quickly after a collision.

**The front air bags operate only when the ignition switch is placed in the ON position.**

**After placing the ignition switch in the ON position, the supplemental air bag warning light illuminates. The supplemental air bag warning light will turn off after about 7 seconds if the system is operational.**







**Front passenger air bag and status light**

**⚠ WARNING**

**The front passenger air bag is designed to automatically turn OFF under some conditions. Read this section carefully to learn how it operates. Proper use of the seat, seat belt and child restraints is necessary for most effective protection. Failure to follow all instructions in this manual concerning the use of seats, seat belts and child restraints can increase the risk or severity of injury in an accident.**

## Status light

The front passenger air bag status light  is located near the radio controls. After the ignition switch is placed in the "ON" position, the front passenger air bag status light on the instrument panel illuminates for about 7 seconds and then turns off or remains illuminated depending on the front passenger seat occupied status. The light operates as follows:

- Unoccupied passenger's seat: The  light is OFF and the front passenger air bag is OFF and will not inflate in a crash.
- Passenger's seat occupied by a small adult, child or child restraint as outlined in this section: The  light illuminates to indicate that the front passenger air bag is OFF and will not inflate in a crash.
- Occupied passenger seat and the passenger meets the conditions outlined in this section: The light  light is OFF to indicate that the front passenger air bag is operational.

## Front passenger air bag

The front passenger air bag is designed to automatically turn OFF when the vehicle is operated under some conditions as described below in accordance with U.S. regulations. If the front

passenger air bag is OFF, it will not inflate in a crash. The driver air bag and other air bags in your vehicle are not part of this system.

The purpose of the regulation is to help reduce the risk of injury or death from an inflating air bag to certain front passenger seat occupants, such as children, by requiring the air bag to be automatically turned OFF. Certain sensors are used to meet the requirements.

The occupant classification sensor in this vehicle is a weight sensor. It is designed to detect an occupant and objects on the seat by weight. For example, if a child is in the front passenger seat, the Advanced Air Bag System is designed to turn the passenger air bag OFF in accordance with the regulations. Also, if a child restraint of the type specified in the regulations is on the seat, its weight and the child's weight can be detected and cause the air bag to turn OFF.

Front passenger seat adult occupants who are properly seated and using the seat belt as outlined in this manual should not cause the passenger air bag to be automatically turned OFF. For small adults it may be turned OFF, however if the occupant takes his/her weight off the seat cushion (for example, by not sitting upright, by sitting on an edge of the seat, or by otherwise being out of position), this could cause the sensor to turn the air bag OFF. Always be sure to be seated and

wearing the seat belt properly for the most effective protection by the seat belt and supplemental air bag.

NISSAN recommends that pre-teens and children be properly restrained in a rear seat. NISSAN also recommends that appropriate child restraints and booster seats be properly installed in a rear seat. If this is not possible, the occupant classification sensor is designed to operate as described above to turn the front passenger air bag OFF for specified child restraints as required by the regulations. Failing to properly secure child restraints and to use the ALR mode may allow the restraint to tip or move in an accident or sudden stop. This can also result in the passenger air bag inflating in a crash instead of being OFF. See "Child restraints" in this section for proper use and installation.

If the front passenger seat is not occupied, the passenger air bag is designed not to inflate in a crash. However, heavy objects placed on the seat could result in air bag inflation, because of the object's weight detected by the occupant classification sensor. Other conditions could also result in air bag inflation, such as if a child is standing on the seat, or if two children are on the seat, contrary to the instructions in this manual. Always be sure that you and all vehicle occupants are seated and restrained properly.

Using the passenger air bag status light, you can monitor when the front passenger air bag is automatically turned OFF with the seat occupied. The light will not illuminate when the front passenger seat is unoccupied.

If an adult occupant is in the seat but the passenger air bag status light is illuminated (indicating that the air bag is OFF), it could be that the person is a small adult, or is not sitting on the seat properly or not using the seat belt properly.

If a child restraint must be used in the front seat, the passenger air bag status light may or may not be illuminated, depending on the size of the child and the type of child restraint being used. If the air bag status light is not illuminated (indicating that the air bag might inflate in a crash), it could be that the child restraint or seat belt is not being used properly. Make sure that the child restraint is installed properly, the seat belt is used properly and the occupant is positioned properly. If the air bag status light is not illuminated, reposition the occupant or child restraint in a rear seat.

If the passenger air bag status light will not illuminate even though you believe that the child restraint, the seat belts and the occupant are properly positioned, the system may be sensing an unoccupied seat (in which case the air bag is OFF). Your NISSAN dealer can check that the system is OFF by using a special tool. However,

until you have confirmed with your dealer that your air bag is working properly, reposition the occupant or child restraint in a rear seat.

The air bag system and passenger air bag status light will take a few seconds to register a change in the passenger seat status. For example, if a large adult who is sitting in the front passenger seat exits the vehicle, the passenger air bag status light will go from OFF to ON for a few seconds and then to OFF. This is normal system operation and does not indicate a malfunction.

If a malfunction occurs in the front passenger air bag system, the supplemental air bag warning light , located in the meter and gauges area of the instrument panel, will blink. Have the system checked by a NISSAN dealer.

#### **Other supplemental front-impact air bag precautions**

#### **WARNING**

- **Do not place any objects on the steering wheel pad or on the instrument panel. Also, do not place any objects between any occupant and the steering wheel or instrument panel. Such objects may become dangerous projectiles and cause injury if the front air bags inflate.**

- **Immediately after inflation, several front air bag system components will be hot. Do not touch them; you may severely burn yourself.**
- **No unauthorized changes should be made to any components or wiring of the supplemental air bag system. This is to prevent accidental inflation of the supplemental air bag or damage to the supplemental air bag system.**
- **Do not make unauthorized changes to your vehicle's electrical system, suspension system or front end structure. This could affect proper operation of the front air bag system.**
- **Tampering with the front air bag system may result in serious personal injury. Tampering includes changes to the steering wheel and the instrument panel assembly by placing material over the steering wheel pad and above the instrument panel or by installing additional trim material around the air bag system.**
- **Removing or modifying the front passenger seat may affect the function of the air bag and result in serious personal injury.**

- Modifying or tampering with the front passenger seat may result in serious personal injury. For example, do not change the front seats by placing material on the seat cushion or by installing additional trim material, such as seat covers, on the seat that are not specifically designed to assure proper air bag operation. Additionally, do not stow any objects under the front passenger seat or the seat cushion and seatback. Such objects may interfere with the proper operation of the occupant classification sensor (weight sensor).
- No unauthorized changes should be made to any components or wiring of the seat belt system. This may affect the front air bag system. Tampering with the seat belt system may result in serious personal injury.

- Work on and around the front air bag system should be done by a NISSAN dealer. Installation of electrical equipment should also be done by a NISSAN dealer. The Supplemental Restraint System (SRS) wiring harnesses\* should not be modified or disconnected. Unauthorized electrical test equipment and probing devices should not be used on the air bag system.
- A cracked windshield should be replaced immediately by a qualified repair facility. A cracked windshield could affect the function of the supplemental air bag system.

**\*The SRS wiring harness connectors are yellow and orange for easy identification.**

When selling your vehicle, we request that you inform the buyer about the front air bag system and guide the buyer to the appropriate sections in this Owner's Manual.

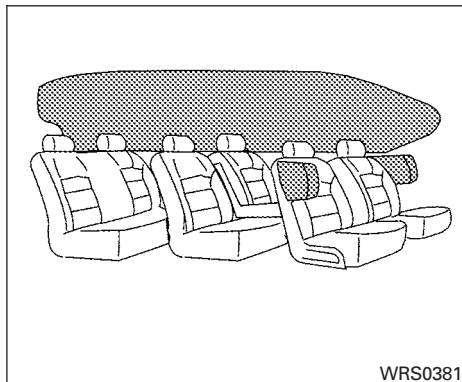

WRS0381

Front seat-mounted side-impact supplemental air bag and roof-mounted curtain side-impact and rollover supplemental air bag systems

The side air bags are located in the outside of the seatback of the front seats. The curtain air bags are located in the side roof rails in all 3 rows. **All of the information, cautions and warnings in this manual apply and must be followed.** The side air bags and curtain air bags are designed to inflate in higher severity side collisions, although they may inflate if the forces in another type of collision are similar to those of a higher severity impact. They are designed to inflate on

the side where the vehicle is impacted. They may not inflate in certain side collisions.

Curtain air bags are also designed to inflate in certain types of rollover collisions or near roll-overs. As a result, certain vehicle movements (for example, during severe off roading) may cause the curtain air bags to inflate.

Vehicle damage (or lack of it) is not always an indication of proper side air bag and curtain air bag operation.

When the side air bags and curtain air bags inflate, a fairly loud noise may be heard, followed by release of smoke. This smoke is not harmful and does not indicate a fire. Care should be taken not to inhale it, as it may cause irritation and choking. Those with a history of a breathing condition should get fresh air promptly.

Side air bags, along with the use of seat belts, help to cushion the impact force on the chest of the front occupants. Curtain air bags help to cushion the impact force to the head of occupants in the front and rear outboard seating positions in all rows. They can help save lives and reduce serious injuries. However, an inflating side air bag or curtain air bag may cause abrasions or other injuries. Side air bags and curtain air bags do not provide restraint to the lower body.

## 1-54 Safety—Seats, seat belts and supplemental restraint system

The seat belts should be correctly worn and the driver and passenger seated upright as far as practical away from the side air bag. Rear seat passengers should be seated as far away as practical from the door finishers and side roof rails. The side air bags and curtain air bags inflate quickly in order to help protect the occupants. Because of this, the force of the side air bags and curtain air bags inflating can increase the risk of injury if the occupant is too close to, or is against, these air bag modules during inflation. The side air bag will deflate quickly after the collision is over.

The curtain air bag will remain inflated for a short time.

**The side air bags and curtain air bags operate only when the ignition switch is placed in the ON position.**

**After placing the ignition switch in the ON position, the supplemental air bag warning light illuminates. The supplemental air bag warning light will turn off after about 7 seconds if the system is operational.**

### WARNING

- **Do not place any objects near the seat-back of the front seats. Also, do not place any objects (an umbrella, bag, etc.) between the front door finisher and the front seat. Such objects may become dangerous projectiles and cause injury if a side air bag inflates.**
- **Right after inflation, several side air bag and curtain air bag system components will be hot. Do not touch them; you may severely burn yourself.**
- **No unauthorized changes should be made to any components or wiring of the side air bag and curtain air bag systems. This is to prevent damage to or accidental inflation of the side air bag and curtain air bag systems.**
- **Do not make unauthorized changes to your vehicle's electrical system, suspension system or side panel. This could affect proper operation of the curtain air bag systems.**

- **Tampering with the side air bag system may result in serious personal injury. For example, do not change the front seats by placing material near the seat-backs or by installing additional trim material, such as seat covers, around the side air bag.**
- **Work around and on the side air bag and curtain air bag systems should be done by a NISSAN dealer. Installation of electrical equipment should also be done by a NISSAN dealer. The SRS wiring harnesses\* should not be modified or disconnected. Unauthorized electrical test equipment and probing devices should not be used on the side air bag or curtain air bag systems.**

**\* The SRS wiring harness or connectors are yellow or orange for easy identification.**

When selling your vehicle, we request that you inform the buyer about the side air bags and curtain air bag system and guide the buyer to the appropriate sections in this Owner's Manual.

Seat belts with pretensioners (front seats)

#### **WARNING**

- **If the vehicle becomes involved in a collision but a pretensioner is not activated, be sure to have the pretensioner system checked and, if necessary, replaced by your NISSAN dealer.**
- **No unauthorized changes should be made to any components or wiring of the pretensioner system. This is to prevent damage to or accidental activation of the pretensioners. Tampering with the pretensioner system may result in serious personal injury.**
- **Work around and on the pretensioner system should be done by a NISSAN dealer. Installation of electrical equipment should also be done by a NISSAN dealer. Unauthorized electrical test equipment and probing devices should not be used on the pretensioner system.**
- **If you need to dispose of a pretensioner or scrap the vehicle, contact a NISSAN dealer. Incorrect disposal procedures could cause personal injury.**

The pretensioner system may activate with the supplemental air bag system in certain types of collisions. Working with the seat belt retractor, the pretensioner helps tighten the seat belt when the vehicle becomes involved in certain types of collisions, helping to restrain front seat occupants.

The pretensioner is encased with the seat belt retractor. These seat belts are used the same way as conventional seat belts.

When a pretensioner activates, smoke is released and a loud noise may be heard. This smoke is not harmful and does not indicate a fire. Care should be taken not to inhale it, as it may cause irritation and choking. Those with a history of a breathing condition should get fresh air promptly.

After pretensioner activation, load limiters allow the seat belt to release webbing (if necessary) to reduce forces against the chest.

The supplemental air bag warning light  is used to indicate malfunctions in the pretensioner system. See "Supplemental Air Bag Warning Light" in this section for more details. If the operation of the supplemental air bag warning light indicates there is a malfunction, have the system checked by a NISSAN dealer.



When selling your vehicle, we request that you inform the buyer about the pretensioner system and guide the buyer to the appropriate sections in this Owner's Manual.

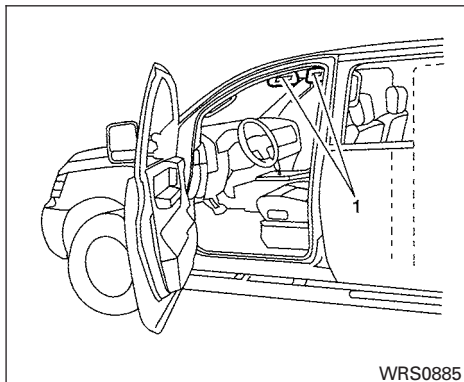

#### 1. SRS Air Bag Warning Labels

The warning labels are located on the surface of the sun visor.

### SUPPLEMENTAL AIR BAG WARNING LABELS

Warning labels about the supplemental front-impact air bag system are placed in the vehicle as shown in the illustration.



### SUPPLEMENTAL AIR BAG WARNING LIGHT

The supplemental air bag warning light, displaying  in the instrument panel, monitors the circuits for the air bag systems, pretensioners and all related wiring.

When the ignition switch is placed in the ON position, the supplemental air bag warning light illuminates for about 7 seconds and then turns off. This means the system is operational.

If any of the following conditions occur, the front air bag, side air bag, curtain air bag and pretensioner systems need servicing:

- The supplemental air bag warning light remains on after approximately 7 seconds.
- The supplemental air bag warning light flashes intermittently.
- The supplemental air bag warning light does not come on at all.

Under these conditions, the front air bag, side air bag, curtain air bag or pretensioner systems may not operate properly. They must be checked and repaired. Take your vehicle to the nearest NISSAN dealer.

 **WARNING**

**If the supplemental air bag warning light is on, it could mean that the front air bag, side air bag, curtain air bag and/or pretensioner systems will not operate in an accident. To help avoid injury to yourself or others, have your vehicle checked by a NISSAN dealer as soon as possible.**

## Repair and replacement procedure

The front air bags, side air bags, curtain air bags and pretensioners are designed to inflate on a one-time-only basis. As a reminder, unless it is damaged, the supplemental air bag warning light remains illuminated after inflation has occurred. Repair and replacement of these supplemental air bag systems should be done only by a NISSAN dealer.

When maintenance work is required on the vehicle, the front air bags, side air bags, curtain air bags, pretensioners and related parts should be pointed out to the person performing the maintenance. The ignition switch should always be in the LOCK position when working under the hood or inside the vehicle.

 **WARNING**

- **Once a front air bag, side air bag, or curtain air bag has inflated, the air bag module will not function again and must be replaced. Additionally, the activated pretensioners must also be replaced. The air bag module and pretensioner should be replaced by a NISSAN dealer. The air bag module and pretensioner cannot be repaired.**

- **The front air bag, side air bag, curtain air bag systems and the pretensioner system should be inspected by a NISSAN dealer if there is any damage to the front end or side portion of the vehicle.**
- **If you need to dispose of a supplemental air bag or pretensioner or scrap the vehicle, contact a NISSAN dealer. Incorrect disposal procedures could cause personal injury.**

## 2 Instruments and controls

Instrument panel.....	2-2	Switch operation.....	2-33
Meters and gauges.....	2-3	Rear window wiper and washer switch.....	2-33
Speedometer and odometer.....	2-4	Rear window and outside mirror (if so equipped) defroster switch.....	2-34
Tachometer.....	2-4	Headlight and turn signal switch.....	2-35
Engine coolant temperature gauge.....	2-5	Headlight control switch.....	2-35
Fuel gauge.....	2-5	Daytime running light system.....	2-37
Compass display (if so equipped).....	2-6	Instrument brightness control.....	2-37
Compass display.....	2-6	Turn signal switch.....	2-38
Warning/indicator lights and audible reminders.....	2-9	Fog light switch (if so equipped).....	2-38
Checking bulbs.....	2-9	Horn.....	2-38
Warning lights.....	2-10	Heated seats (if so equipped).....	2-39
Indicator lights.....	2-14	Vehicle Dynamic Control (VDC) off switch.....	2-40
Audible reminders.....	2-16	All-wheel drive (AWD) lock switch (if so equipped).....	2-40
Vehicle Information Display.....	2-17	SPORT mode switch (if so equipped).....	2-40
How to use the vehicle information display.....	2-17	Hill descent switch (if so equipped).....	2-41
Startup display.....	2-18	Warning systems switch (if so equipped).....	2-42
Settings.....	2-18	Power outlets.....	2-42
Vehicle information display warnings and indicators.....	2-27	12v outlets.....	2-42
Security systems.....	2-30	Storage.....	2-44
Vehicle security system.....	2-30	Seatback pockets.....	2-44
NISSAN vehicle immobilizer system.....	2-31	Sunglasses holder.....	2-44
Windshield wiper and washer switch.....	2-32	Cup holders.....	2-45

Glove box .....	2-46
Console box .....	2-47
Luggage hooks .....	2-47
Cargo area storage bin .....	2-48
Roof rack (if so equipped) .....	2-48
Divide-n-hide® adjustable floor (if so equipped) .....	2-49
Windows .....	2-50
Power windows .....	2-50
Power panoramic sunroof (if so equipped) .....	2-52
Interior light .....	2-54
Console light (if so equipped) .....	2-55

Map lights .....	2-55
Cargo light .....	2-56
HomeLink® universal transceiver (if so equipped) .....	2-56
Programming HomeLink® .....	2-57
Programming HomeLink® for Canadian customers and gate openers .....	2-58
Operating the HomeLink® universal transceiver .....	2-59
Programming trouble-diagnosis .....	2-59
Clearing the programmed information .....	2-59
Reprogramming a single HomeLink® button .....	2-60
If your vehicle is stolen .....	2-60

## INSTRUMENT PANEL

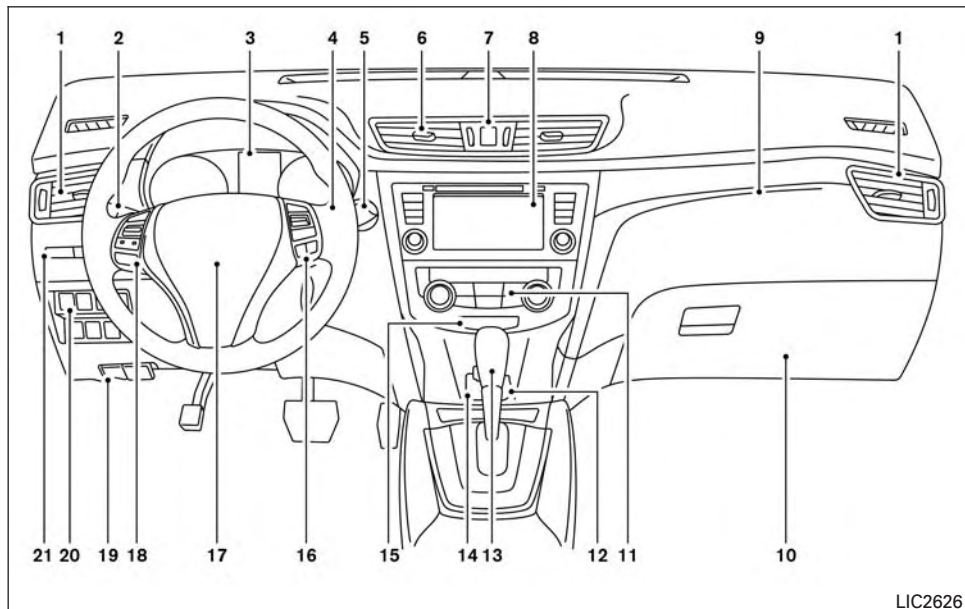

1. Vent (P. 4-25)
2. Headlight/fog light (if so equipped)/turn signal switch (P. 2-35)
3. Meters, gauges, warning/indicator lights and Vehicle Information Display (P. 2-3, P.2-17)

4. Windshield wiper/washer switch and rear window wiper/washer switch (P. 2-32, P. 2-33)/Ignition switch (if so equipped) (P. 5-8)
5. Push-button ignition switch (if so equipped) (P. 5-11)

6. Vent (P. 4-25)
7. Hazard warning flasher switch (P. 6-2)
8. Radio (P. 4-37)/Navigation system\* (if so equipped)
9. Front passenger supplemental air bag (P. 1-41)
10. Glove box (P. 2-46)
11. Heater and air conditioning controls (P. 4-26)
12. Power outlet (P. 2-42)
13. Shift lever (P. 5-16)
14. Auxiliary jack (P. 1-41)/USB port (P. 4-64)
15. Front passenger air bag status light (P. 1-41)
16. Cruise control main/set switches (P. 5-27/Bluetooth Hands-Free Phone System (if so equipped) (P. 4-37)
17. Driver supplemental air bag/Horn (P.1-41, P. 2-38)
18. Control panel and Vehicle Information Display switches (P.2-17)
19. Hood release (P. 3-22)/Fuel door release (P. 3-27)

### 2-2 Instruments and controls

## METERS AND GAUGES

- 20. Vehicle Dynamic Control (VDC) OFF switch (P. 2-40)
- Sport mode switch (P. 2-40)
- Power liftgate switch (if so equipped) (P.3-23)
- Power liftgate main switch (if so equipped) (P. 3-26)
- Warning systems switch (if so equipped) (P.2-42)
- All-Wheel Drive (AWD) lock switch (if so equipped) (P.2-40)
- Hill descent control switch (if so equipped) (P.2-41)
- 21. Instrument brightness control (P. 2-37)/Twin trip odometer reset switch (P. 2-4)

\*: Refer to the separate Navigation System Owner's Manual (if so equipped).

**See the page number indicated in parentheses for operating details.**

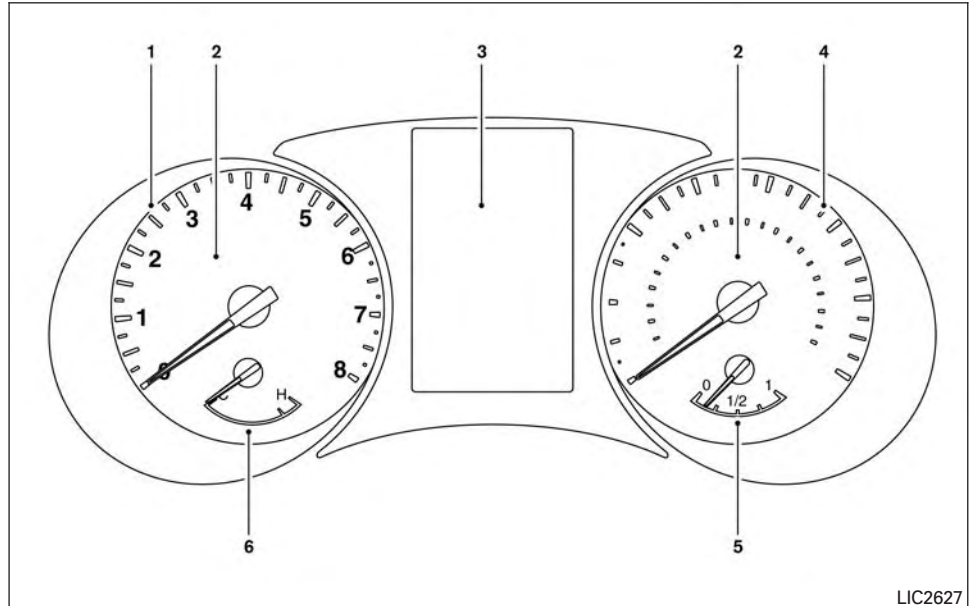

LIC2627

- 1. Tachometer
- 2. Warning/indicator lights
- 3. Vehicle Information Display/Odometer/  
Twin trip odometer
- 4. Speedometer
- 5. Fuel gauge
- 6. Engine coolant temperature gauge

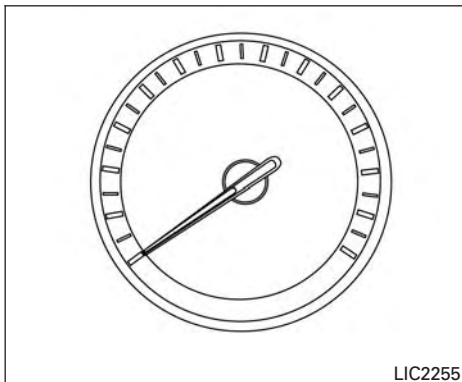

## SPEEDOMETER AND ODOMETER

### Speedometer

The speedometer indicates vehicle speed.

### Odometer/Twin trip odometer

The odometer ① and the twin trip odometer ② are displayed below the Vehicle Information Display when the ignition switch is placed in the ON position.

The odometer records the total distance the vehicle has been driven.

The twin trip odometer records the distance of individual trips.

## 2-4 Instruments and controls

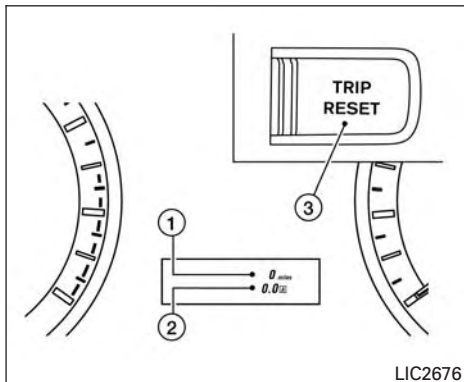

### Changing the display:

Pushing the TRIP RESET ③ switch on the instrument panel to change the display as follows:

Trip **A** → Trip **B** → Trip **A**

### Resetting the trip odometer:

Pushing the TRIP RESET switch ③ for more than 1 second resets the currently displayed trip odometer to zero.

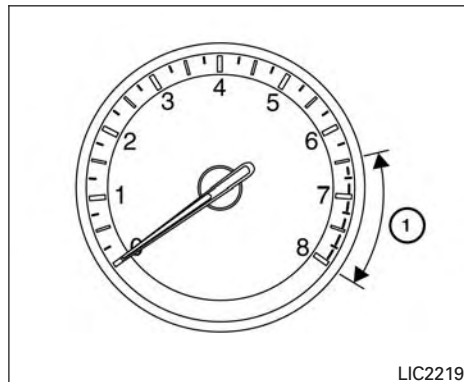

## TACHOMETER

The tachometer indicates engine speed in revolutions per minute (rpm). Do not rev engine into the red zone ①.

### **CAUTION**

**When engine speed approaches the red zone, reduce engine speed. Operating the engine in the red zone may cause serious engine damage.**

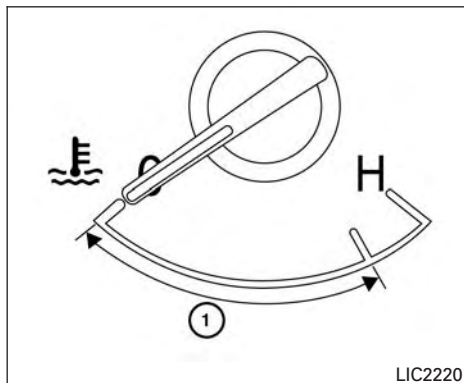

### ENGINE COOLANT TEMPERATURE GAUGE

The gauge indicates the engine coolant temperature. The engine coolant temperature is within the normal range ① when the gauge needle points within the zone shown in the illustration.

The engine coolant temperature varies with the outside air temperature and driving conditions.

### ⚠ CAUTION

If the gauge indicates coolant temperature near the hot (H) end of the normal range, reduce vehicle speed to decrease temperature. If the gauge is over the normal range, stop the vehicle as soon as safely possible. If the engine is overheated, continued operation of the vehicle may seriously damage the engine. See “If your vehicle overheats” in the “In case of emergency” section for immediate action required.

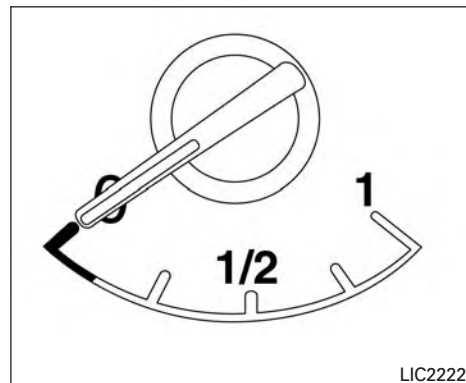

### FUEL GAUGE

The gauge indicates the **approximate** fuel level in the tank.

The gauge may move slightly during braking, turning, acceleration, or going up or down hills.

The gauge needle returns to 0 (Empty) after the ignition switch is placed in the OFF position.

The low fuel warning light comes on when the amount of fuel in the tank is getting low.



**Refill the fuel tank before the gauge registers 0 (Empty).**



## COMPASS DISPLAY (if so equipped)

The  indicates that the fuel-filler door is located on the driver's side of the vehicle.

### CAUTION

- If the vehicle runs out of fuel, the  Malfunction Indicator Light (MIL) may come on. Refuel as soon as possible. After a few driving trips, the  light should turn off. If the light remains on after a few driving trips, have the vehicle inspected by a NISSAN dealer.
- For additional information, see “Malfunction Indicator Light (MIL)” later in this section.

This unit measures terrestrial magnetism and indicates the heading direction of the vehicle.

With the ignition switch in the ON position, press the  button as described in the charts below to activate various features of the automatic anti-glare rearview mirror.

Push and hold the  button for about:	Feature: (Push button again for about 1 second to change settings)
1 second	Compass display toggles on/off
8 seconds	Compass zone can be changed to correct false compass readings
10 seconds	Compass enters calibration mode

For information about the automatic anti-glare feature, refer to “Automatic anti-glare rearview mirror” in the “Pre-driving checks and adjustments” section.

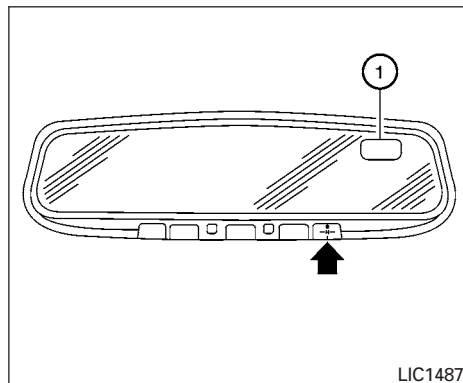

## COMPASS DISPLAY

Push the  button for about 1 second when the ignition switch is placed in the ON position to toggle the compass direction display ① on or off. The display will indicate the direction that the vehicle is heading.

N: North  
E: East  
S: South  
W: West

If the display reads “C”, calibrate the compass by driving the vehicle in three complete circles at less than 5 MPH (8 km/h).

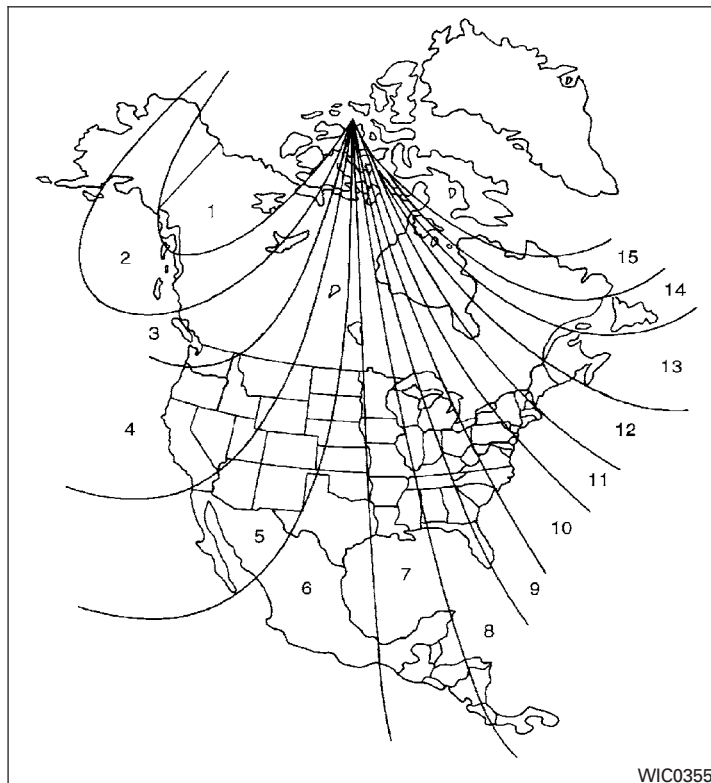

You can also calibrate the compass by driving your vehicle on your everyday route. The compass will be calibrated once it has tracked three complete circles.



WIC0355

## Zone variation change procedure

The difference between magnetic north and geographical north is known as variance. In some areas, this difference can sometimes be great enough to cause false compass readings. Follow these instructions to set the variance for your particular location if this happens:

1. Press and hold the  button for about 8 seconds. The current zone number will appear in the display. Release the button.
2. Find your current location on the zone map. Refer to the illustration.
3. Press the  button repeatedly to toggle through the zone numbers until the desired number appears in the display. Once you have selected a zone number, the display will show a compass direction within a few seconds.

### Inaccurate compass direction:

The compass display is equipped with automatic correction function. If the correct direction is not shown, follow this procedure.























1. With the display turned on, press and hold the  for about 10 seconds. The "C" icon in the compass display will illuminate.

2. Calibrate the compass by driving the vehicle in three complete circles at a maximum speed of 5 MPH (8 km/h).
3. After completing the circles, the display should return to normal.

### CAUTION





- **Do not install a ski rack, antenna, etc., which are attached to the vehicle by means of a magnet. They affect the operation of the compass.**
- **When cleaning the mirror, use a paper towel or similar material dampened with glass cleaner. Do not spray glass cleaner directly on the mirror as it may cause the liquid cleaner to enter the mirror housing.**

## WARNING/INDICATOR LIGHTS AND AUDIBLE REMINDERS

 or 	Anti-lock Braking System (ABS) warning light		Supplemental air bag warning light		Malfunction Indicator Light (MIL)
 or 	Brake warning light		All-Wheel Drive (AWD) AUTO indicator light (if so equipped)		Overdrive off indicator light
	Charge warning light		All-Wheel Drive (AWD) LOCK indicator light (if so equipped)		Security indicator light
	Low tire pressure warning light		Front fog light indicator light (if so equipped)		Slip indicator light
	Master warning light		Front passenger air bag status light		Sport mode indicator light (if so equipped)
	Power steering warning light		High beam indicator light (blue)		Turn signal/hazard indicator lights
	Seat belt warning light and chime		Hill descent indicator light (if so equipped)		Vehicle Dynamic Control (VDC) off indicator light

### CHECKING BULBS

With all doors closed, apply the parking brake and place the ignition switch to the ON position without starting the engine. The following lights will come on:

 , BRAKE or  ,  ,  , PS , 

The following lights come on briefly and then go off:

ABS ,  ,  ,  ,  ,  , 

**If any light fails to come on, it may indicate a burned-out bulb or an open circuit in the electrical system. Have the system repaired promptly.**

## WARNING LIGHTS

For additional information on warnings and indicators, see “Vehicle information display” in this section.

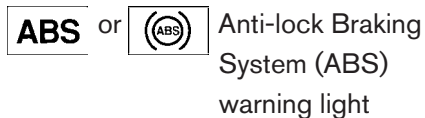

When the ignition switch is placed in the ON position, the Anti-lock Braking System (ABS) warning light illuminates and then turns off. This indicates the ABS is operational.

If the ABS warning light illuminates while the engine is running or while driving, it may indicate the ABS is not functioning properly. Have the system checked by a NISSAN dealer.

If an ABS malfunction occurs, the anti-lock function is turned off. The brake system then operates normally, but without anti-lock assistance. See “Brake system” in the “Starting and driving” section.



This light functions for both the parking brake and the foot brake systems.

### Low brake fluid warning light

When the ignition switch is placed in the ON position, the light warns of a low brake fluid level. If the light comes on while the engine is running with the parking brake not applied, stop the vehicle and perform the following:

1. Check the brake fluid level. Add brake fluid as necessary. See “Brake fluid” in the “Maintenance and do-it-yourself” section of this manual.
2. If the brake fluid level is correct, have the warning system checked by a NISSAN dealer.

### WARNING

- **Your brake system may not be working properly if the warning light is on. Driving could be dangerous. If you judge it to be safe, drive carefully to the nearest service station for repairs. Otherwise, have your vehicle towed because driving it could be dangerous.**
- **Pressing the brake pedal with the engine stopped and/or a low brake fluid level may increase your stopping distance and braking will require greater pedal effort as well as pedal travel.**

- **If the brake fluid level is below the MINIMUM or MIN mark on the brake fluid reservoir, do not drive until the brake system has been checked at a NISSAN dealer.**

### Anti-lock Braking System (ABS) warning indicator

When the parking brake is released and the brake fluid level is sufficient, if both the brake warning light and the Anti-lock Braking System (ABS) warning light illuminate, it may indicate the ABS is not functioning properly. Have the brake system checked, and if necessary, repaired by a NISSAN dealer promptly. Avoid high-speed driving and abrupt braking. See “Anti-lock Braking System (ABS) warning light” in this section.



If this light comes on while the engine is running, it may indicate the charging system is not functioning properly. Turn the engine off and check the generator belt. If the belt is loose, broken, missing, or if the light remains on, see a NISSAN dealer immediately.

### CAUTION

- **Do not ground electrical accessories directly to the battery terminal. Doing so will bypass the variable control system and the vehicle battery may not charge completely. Refer to “Variable voltage control system” in the “Maintenance and do-it-yourself” section later in this manual.**
- **Do not continue driving if the generator belt is loose, broken or missing.**



### Low tire pressure warning light

Your vehicle is equipped with a Tire Pressure Monitoring System (TPMS) that monitors the tire pressure of all tires except the spare.

The low tire pressure warning light warns of low tire pressure or indicates that the TPMS is not functioning properly.

After the ignition switch is placed in the ON position, this light illuminates for about 1 second and turns off.

### Low tire pressure warning:

**If the vehicle is being driven with low tire pressure, the warning light will illuminate. A “Tire Pressure Low Add Air” warning also appears in the vehicle information display.**

**When the low tire pressure warning light illuminates, you should stop and adjust the tire pressure of all 4 tires to the recommended COLD tire pressure shown on the Tire and Loading Information label located in the driver’s door opening. The low tire pressure warning light does not automatically turn off when the tire pressure is adjusted. After the tire is inflated to the recommended pressure, the vehicle must be driven at speeds above 16 MPH (25 km/h) to activate the TPMS and turn off the low tire pressure warning light. Use a tire pressure gauge to check the tire pressure.**

The “Tire Pressure Low Add Air” warning appears each time the ignition switch is placed in the ON position as long as the low tire pressure warning light remains illuminated.

For additional information, see “Vehicle information display” in the “Instruments and controls” section and “Tire Pressure Monitoring System (TPMS)” in the “Starting and driving” section and in the “In case of emergency” section.

### TPMS malfunction:

If the TPMS is not functioning properly, the low tire pressure warning light will flash for approximately 1 minute when the ignition switch is placed in the ON position. The light will remain on after the 1 minute. Have the system checked by a NISSAN dealer. The “Tire Pressure Low Add Air” warning does not appear if the low tire pressure warning light illuminates to indicate a TPMS malfunction.

For additional information, see “Tire Pressure Monitoring System (TPMS)” in the “Starting and driving” section and “Tire pressure” in the “Maintenance and do-it-yourself” section.

### WARNING

- **Radio waves could adversely affect electric medical equipment. Those who use a pacemaker should contact the electric medical equipment manufacturer for the possible influences before use.**
- **If the light does not illuminate with the ignition switch placed in the ON position, have the vehicle checked by a NISSAN dealer as soon as possible.**

- If the light illuminates while driving, avoid sudden steering maneuvers or abrupt braking, reduce vehicle speed, pull off the road to a safe location and stop the vehicle as soon as possible. Driving with under-inflated tires may permanently damage the tires and increase the likelihood of tire failure. Serious vehicle damage could occur and may lead to an accident and could result in serious personal injury. Check the tire pressure for all four tires. Adjust the tire pressure to the recommended COLD tire pressure shown on the Tire and Loading Information label located in the driver's door opening to turn the low tire pressure warning light OFF. If the light still illuminates while driving after adjusting the tire pressure, a tire may be flat. If you have a flat tire, replace it with a spare tire as soon as possible.

- When a spare tire is mounted or a wheel is replaced tire pressure will not be indicated, the TPMS will not function and the low tire pressure warning light will flash for approximately 1 minute. The light will remain on after 1 minute. Contact your NISSAN dealer as soon as possible for tire replacement and/or system resetting.
- Replacing tires with those not originally specified by NISSAN could affect the proper operation of the TPMS.

#### CAUTION

- The TPMS is not a substitute for the regular tire pressure check. Be sure to check the tire pressure regularly.
- If the vehicle is being driven at speeds of less than 16 MPH (25 km/h), the TPMS may not operate correctly.
- Be sure to install the specified size of tires to the 4 wheels correctly.



#### Master warning light

When the ignition is in the ON position, the master warning light illuminates if any of the following are displayed on the vehicle information display.

- All-Wheel Drive (AWD) Tire Size Incorrect See Owner's Manual
- All-Wheel Drive (AWD) High Temp. Stop vehicle
- All-Wheel Drive (AWD) Error See Owner's Manual
- No key warning
- Low fuel warning
- Low windshield-washer fluid warning
- Parking brake release warning
- Door/liftgate open warning
- Loose fuel cap



## Power steering warning light

### WARNING

- **If the engine is not running or is turned off while driving, the power assist for the steering will not work. Steering will be harder to operate.**
- **When the power steering warning light illuminates with the engine running, there will be no power assist for the steering. You will still have control of the vehicle, but the steering will be much harder to operate. Have the power steering system checked by a NISSAN dealer.**

When the ignition switch is in the ON position, the power steering warning light illuminates. After starting the engine, the power steering warning light turns off. This indicates that the electric power steering system is operational. If the power steering warning light illuminates while the engine is running, it may indicate the power steering system is not functioning properly and may need servicing. Have the electric power steering system checked by a NISSAN dealer. See "Power steering system" in the "Starting and driving" section.



## Seat belt warning light and chime

The light and chime remind you to fasten your seat belts. The light illuminates whenever the ignition switch is placed in the ON or START position and remains illuminated until the driver's seat belt is fastened. At the same time, the chime sounds for about 6 seconds unless the driver's seat belt is securely fastened.

The seat belt warning light may also illuminate if the front passenger's seat belt is not fastened when the front passenger's seat is occupied. For 7 seconds after the ignition switch is placed in the ON position, the system does not activate the warning light for the front passenger.

Refer to "Seat belts" in the "Safety—Seats, seat belts and supplemental restraint system" section for precautions on seat belt usage.



## Supplemental air bag warning light

When the ignition switch is placed in the ON or START position, the supplemental air bag warning light illuminates for about 7 seconds and then turns off. This means the system is operational.

If any of the following conditions occur, the front air bag, side air bag, curtain air bag, and pretensioner systems need servicing and your vehicle must be taken to a NISSAN dealer:

- The supplemental air bag warning light remains on after approximately 7 seconds.
- The supplemental air bag warning light flashes intermittently.
- The supplemental air bag warning light does not come on at all.

Unless checked and repaired, the supplemental restraint system (air bag system) and/or the seat belts with pretensioner system may not function properly. For additional details see "Supplemental restraint system" in the "Safety—Seats, seat belts and supplemental restraint system" section of this manual.

### WARNING

**If the supplemental air bag warning light is on, it could mean that the front air bag, side air bag, curtain air bag and/or pretensioner systems will not operate in an accident. To help avoid injury to yourself or others, have your vehicle checked by a NISSAN dealer as soon as possible.**



## INDICATOR LIGHTS

For additional information on warnings and indicators, see “Vehicle information display” in this section.



All-Wheel Drive (AWD) AUTO indicator light (if so equipped)

When the ignition switch is in the “ON” position, the All-Wheel Drive (AWD) AUTO indicator light illuminates and then turns off.

When selecting AWD AUTO mode while the engine is running, the AWD AUTO indicator light illuminates simultaneously with the AWD indicator light illuminating.

The AUTO mode indicator light is ON when the ignition switch is in the “ON” position.

### CAUTION

**Do not drive on dry hard surface roads in the AUTO mode.**



All-Wheel Drive (AWD) LOCK indicator light (if so equipped)

When the ignition switch is in the “ON” position, the All-Wheel Drive (AWD) LOCK indicator light illuminates and then turns off.

When selecting AWD LOCK mode while the engine is running, the AWD LOCK indicator light illuminates.

The LOCK mode indicator light is ON when the ignition switch is in the “ON” position.

### CAUTION

**Do not drive on dry hard surface roads in the LOCK mode.**



Front fog light indicator light (if so equipped)

The front fog light indicator light illuminates when the front fog lights are ON. See “Fog light switch” in this section.



Front passenger air bag status light

The front passenger air bag status light will be lit and the passenger front air bag will be OFF depending on how the front passenger seat is being used.

For front passenger air bag status light operation, see “Front passenger air bag and status light” in the “Safety — Seats, seat belts and supplemental restraint system” section of this manual.



High beam indicator light (blue)

This blue light comes on when the headlight high beams are on and goes out when the low beams are selected.

The high beam indicator light also comes on when the passing signal is activated.



Hill descent control system on indicator light (if so equipped)

When the ignition switch is placed in the ON position, this light comes on briefly and then turns off.

The light comes on when the hill descent control system is activated.

If the hill descent control switch is on and the indicator light blinks, the system is not engaged.

If the indicator light does not come on when the hill descent switch is on, the system may not be functioning properly. Have the system checked by a NISSAN dealer.

For additional information, see “Hill descent control switch” later in this section and “Hill descent control system” in the “Starting and driving” section of this manual.



## Malfunction Indicator Light (MIL)

If this indicator light comes on steady or blinks while the engine is running, it may indicate a potential emission control malfunction.



The Malfunction Indicator Light may also come on steady if the fuel-filler cap is loose or missing, or if the vehicle runs out of fuel. Check to make sure the fuel-filler cap is installed and closed tightly, and that the vehicle has at least 3 gallons (11.4 liters) of fuel in the fuel tank.

After a few driving trips, the  light should turn off if no other potential emission control system malfunction exists.

If this indicator light comes on steady for 20 seconds and then blinks for 10 seconds when the engine is not running, it indicates that the vehicle is not ready for an emission control system inspection/maintenance test. See “Readiness for inspection/maintenance (I/M) test” in the “Technical and consumer information” section of this manual.

## Operation

The Malfunction Indicator Light will come on in one of two ways:

- Malfunction Indicator Light on steady — An emission control system malfunction has been detected. Check the fuel-filler cap if the LOOSE FUEL CAP warning appears in the vehicle information display. If the fuel-filler cap is loose or missing, tighten or install the cap and continue to drive the vehicle. The  light should turn off after a few driving trips. If the  light does not turn off after a few driving trips, have the vehicle inspected by a NISSAN dealer. You do not need to have your vehicle towed to the dealer.
- Malfunction Indicator Light blinking — An engine misfire has been detected which may damage the emission control system. To reduce or avoid emission control system damage:
  - do not drive at speeds above 45 MPH (72 km/h).
  - avoid hard acceleration or deceleration.
  - avoid steep uphill grades.
  - if possible, reduce the amount of cargo being hauled or towed.

The Malfunction Indicator Light may stop blinking and come on steady. Have the vehicle inspected by a NISSAN dealer. You do not need to have your vehicle towed to the dealer.

## CAUTION

**Continued vehicle operation without having the emission control system checked and repaired as necessary could lead to poor driveability, reduced fuel economy, and possible damage to the emission control system.**

O/D  
OFF

Overdrive OFF indicator light

The overdrive off indicator light illuminates when the overdrive off mode is selected.

For additional information, see “Continuously Variable Transmission (CVT)” in the “Starting and driving” section of this manual.



Security indicator light

This light blinks when the ignition switch is placed in the OFF, LOCK or ACC (if so equipped) position.

The blinking security indicator light indicates that the security systems equipped on the vehicle are operational.

For additional information, see “Security systems” later in this section.



### Slip indicator light

This indicator will blink when the VDC system is operating, thus alerting the driver to the fact that the road surface is slippery and the vehicle is nearing its traction limits.

You may feel or hear the system working; this is normal.

The light will blink for a few seconds after the VDC system stops limiting wheel spin.

The  indicator light also comes on when you place the ignition switch in the ON position. The light will turn off after approximately 2 seconds if the system is operational. If the light does not come on have the system checked by a NISSAN dealer.



### SPORT mode indicator light (if so equipped)

This light illuminates and then turns off when the ignition switch is placed into the ON position, and when the overdrive off mode off is selected.

For additional information, see “Continuously Variable Transmission (CVT)” in the “Starting and driving” section of this manual.



### Turn signal/hazard indicator lights

The appropriate light flashes when the turn signal switch is activated.

Both lights flash when the hazard switch is turned on.



### Vehicle Dynamic Control (VDC) off indicator light

This indicator light comes on when the Vehicle Dynamic Control off switch is pushed to OFF. This indicates the Vehicle Dynamic Control system is not operating.

Push the Vehicle Dynamic Control off switch again or restart the engine and the system will operate normally. See “Vehicle Dynamic Control (VDC) system” in the “Starting and driving” section of this manual.

The Vehicle Dynamic Control light also comes on when you place the ignition switch in the ON position. The light will turn off after about 2 seconds if the system is operational. If the light stays on or comes on along with the  indicator light while you are driving, have the Vehicle Dynamic Control system checked by a NISSAN dealer.

While the Vehicle Dynamic Control system is operating, you might feel slight vibration or hear the system working when starting the vehicle or accelerating, but this is normal.

## AUDIBLE REMINDERS

### Brake pad wear warning

The disc brake pads have audible wear warnings. When a disc brake pad requires replacement, it makes a high pitched scraping sound when the vehicle is in motion, whether or not the brake pedal is depressed. Have the brakes checked as soon as possible if the warning sound is heard.

### Key reminder chime

A chime sounds if the driver's door is opened while the ignition switch is placed in the ACC (if so equipped) or OFF position or placed in the OFF or LOCK position with the Intelligent Key left in the vehicle. Make sure the ignition switch is placed in the LOCK position, and take the Intelligent Key with you when leaving the vehicle.

### Light reminder chime

With the ignition switch placed in the OFF position, a chime sounds when the driver's door is opened if the headlights or parking lights are on.

Turn the headlight control switch off before leaving the vehicle.

## VEHICLE INFORMATION DISPLAY

### NISSAN Intelligent Key® door buzzer

The Intelligent Key door buzzer sounds if the Intelligent Key is left inside the vehicle when locking the doors. When the buzzer sounds, be sure to check both the vehicle and the Intelligent Key. See "NISSAN Intelligent Key®" in the "Pre-driving checks and adjustments" section.

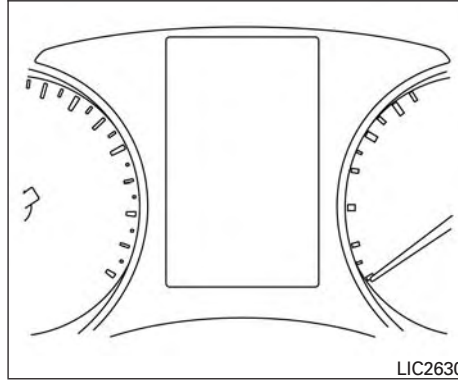

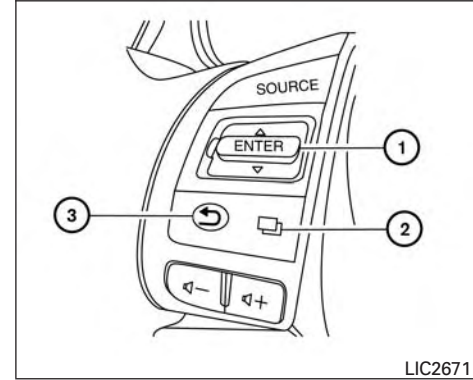

The vehicle information display is located to the left of the speedometer. It displays such items as:

- Vehicle settings
- Trip computer information
- Drive system warnings and settings (if so equipped)
- Cruise control system information
- NISSAN Intelligent Key® operation information
- Chassis Control
- Indicators and warnings (if so equipped)
- Tire Pressure information



### HOW TO USE THE VEHICLE INFORMATION DISPLAY

The vehicle information display can be changed using the buttons  and ENTER located on the steering wheel.

1.  — navigate through the items in vehicle information  
ENTER — change or select an item in the vehicle information display
2.  — select/enter the Vehicle information menu items or to change from one display screen to the next (i.e. trip, TPMS, Fuel economy)

3.  — go back to the previous menu

The ENTER and  buttons also control audio and control panel functions. For additional information see, “Steering wheel switch for audio control” in “Monitor, climate, audio, phone and voice recognition systems” section.

## STARTUP DISPLAY

When the vehicle is placed in the ON or ACC (if so equipped) position the screens that display in the vehicle information include:

- Active system status (if so equipped)
- Trip computer
- Tire pressure information
- Fuel economy
- Warnings
- Outside air temperature
- Odometer/Twin Trip Odometer

Warnings will only display if there are any present, for more information on warnings and indicators see, “Vehicle information display warnings and indicators” in this section.

To control what items display in the vehicle information display, see “Main menu selection” in this section.

## 2-18 Instruments and controls

## SETTINGS

The setting mode allows you to change the information displayed in the vehicle information display:

- Driver Assistance
- Clock (if so equipped)
- Meter Settings
- Vehicle Settings
- Maintenance
- Alarm
- Unit
- Language
- Factory Reset

### Driver Assistance

To change the status, warnings or turn on or off any of the systems/warnings displayed in the “Driver Assistance” menu:

Use the  button to select and the ENTER button to change a menu item:

- Driving Aids (if so equipped)
  - Forward (FCW) On/Off
  - Lane (LDW) On/Off

– Blind Spot (BSW) On/Off

- Parking Aids (if so equipped)
  - Moving Object On/Off

- Chassis Control



- Trace Control – See “Active Trace Control” in “Starting and Operating” for more information.
- Engine Brake – See “Active Engine Brake” in “Starting and Operating” for more information.

### Clock (if so equipped)

To set the clock, see “Monitor, climate, audio, phone and voice recognition” in this manual or the separate Navigation Owner’s Manual.

### Meter Settings

The meter settings allows the customer to choose from the various meter selections.

The meter settings can be changed using the , , and the ENTER buttons.

## Main Menu Selection

The items that display can be enabled/disabled when the ignition switch is placed in the ON position. To change the items that display.

Use the  button to select and the ENTER button to change a menu item:

- Trip Computer – See “Trip Computer” in this section.
- Range
- Average Speed
- Fuel Economy
- Navigation (if so equipped)
- Audio/Satellite Radio (if so equipped)
- Driving Aids (if so equipped)
- Tire Pressures
- Warning Confirmation

## Body Color

The color of the vehicle that displays in the vehicle information display when the ignition switch is placed in the ON position can be changed.

## ECO Drive Report



The following information can be enabled/disabled to display in the vehicle information display when the ignition switch is placed in the ON position.

From the “Main Menu Selection” select “ECO Drive Report” to display the information when the ignition switch is placed in the ON position.

- Select “Display” then “On” or “Off” to display the information when the ignition switch is placed in the ON position. The ECO Drive Report is displayed when the ignition switch is in the OFF position.

## Welcome Effects

The welcome screen display can be turned ON/OFF to display when the ignition switch is placed in the ACC (if so equipped) or ON position. To enable/disable the welcome screen:

1. Press the  button.
2. Use the  buttons to select “Settings”, and press ENTER.
3. Select “Welcome Effects” using the  buttons and press ENTER to turn this function ON or OFF.

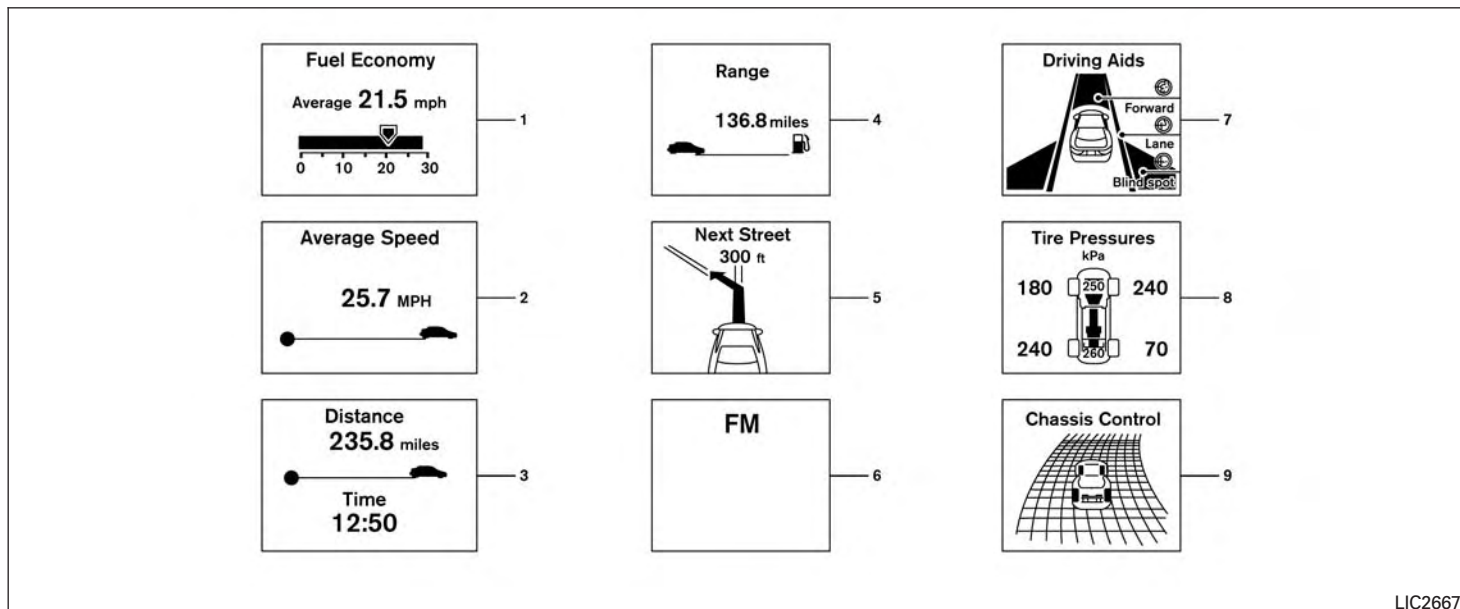

LIC2667

## Trip Computer

The trip computer can be enabled/disabled to display in the vehicle information display when the ignition switch is placed in the ON position.

From the “Main Menu Selection” select “Trip Computer” to display in the vehicle information display when the ignition is placed in the ON position.

**1. Current fuel consumption and average fuel consumption (MPG, l (liter) /100km or km/l)**

### **Current fuel consumption:**

The current fuel consumption mode shows the current fuel consumption.

### **Average fuel consumption:**

The average fuel consumption mode shows the average fuel consumption since the last reset. Resetting is done by pushing the  button for longer than one second.

The display is updated every 30 seconds. At about the first 1/3 mile (500 m) after a reset, the display shows “\_ \_”.

### **2. Average speed (MPH or km/h)**

The average speed mode shows the average vehicle speed since the last reset. Resetting is done by pushing the  button for longer than one second.

The display is updated every 30 seconds. At about the first 1/3 mile (500 m) after a reset, the display shows “\_ \_”.

### **3. Elapsed time and trip odometer (mile or km)**

#### **Elapsed time:**

The elapsed time mode shows the time since the last reset. Resetting is done by pushing

the  button for longer than one second. (The trip odometer is also reset at same time.)

#### **Trip odometer:**

The trip odometer mode shows the total distance the vehicle has been driven since the last reset. Resetting is done by pushing the  button for longer than one second. (The elapsed time is also reset at same time.)

### **4. Distance to empty (dte – mile or km)**

The distance to empty (dte) mode provides you with an estimation of the distance that can be driven before refueling. The dte is constantly being calculated, based on the amount of fuel in the fuel tank and the actual fuel consumption.

The display is updated approximately every 30 seconds.

The dte mode includes a low range warning feature. If the fuel level is low, the warning is displayed on the screen.

When the fuel level drops even lower, the dte display will change to “\_ \_”.

- If the amount of fuel added is small, the display just before the ignition switch is pushed to the OFF position may continue to be displayed.

- When driving uphill or rounding curves, the fuel in the tank shifts, which may momentarily change the display.

### **5. Navigation (if so equipped)**

When the route guidance is set in the navigation system, this item shows the navigation route information.

### **6. Audio**

The audio mode shows the status of audio information.

### **7. Driving aids (if so equipped)**

The driving aids mode shows the operating condition for the following systems.

- Lane Departure Warning (LDW)
- Blind Spot Warning (BSW)
- Forward Collision Warning (FCW)

See “Lane Departure Warning (LDW)/Blind Spot Warning (BSW)” and “Forward Collision Warning (FCW)” in “Starting and Driving” for more information.

### **8. Tire pressure**

The tire pressure mode shows the pressure of all four tires while the vehicle is driven. The axle between the tires will also display the recommended tire pressure.



When the “Tire Pressure Low Add Air” or “Flat Tire Visit Dealer” warning appears, the display can be switched to the tire pressure mode by pushing the  button.



The tire pressure unit can be changed in the TPMS setting under the Settings menu on the Vehicle Information Display. See “Vehicle Information Display” in “Instruments and Controls” for more information.

### **9. Chassis control**

When the Active Trace Control, Active Engine Brake, or the Active Ride Control is operated, it shows the operating condition. It also shows operating condition of Hill Start Assist or the Hill Descent Control. See “Active Trace Control, Active Engine Brake, Active Ride Control, Hill Start Assist or the Hill Descent Control” in “Starting and Driving” for more information.

### **Vehicle Settings**

The vehicle settings allows the customer to change settings for interior lights, turn signals, intelligent key settings, unlock settings and other vehicle settings.

The vehicle settings can be changed using the , , , and the ENTER buttons.

## **2-22 Instruments and controls**

### **Welcome light (if so equipped)**

The welcome light can be set to be ON or OFF. From the Vehicle Settings menu, select “Welcome Light”. Use the ENTER button to turn this feature ON or OFF.

### **Auto Room Lamp**

The interior lights can be set to be ON or OFF if any door is unlocked. From the Vehicle Settings menu, select “Auto Room Light”. Use the ENTER button to turn this feature ON or OFF.

### **Light Sensitivity (if so equipped)**

The light sensitivity can be set to illuminate earlier based on the brightness outside the vehicle. From the Vehicle Settings menu, select “Light Sensitivity”. Use the ENTER button to change the sensitivity.

### **Light Off Delay (if so equipped)**

The duration of the automatic headlights can be changed from 0 to 180 seconds. From the Vehicle Settings menu, select “Light Off Delay”. Use the ENTER button to change the duration.

### **3 Flash Pass**

The 3 flash pass can be set to be ON or OFF. From the Vehicle Settings menu, select “3 Flash Pass”. Use the ENTER button to turn this feature ON or OFF.

### **I-Key Door Lock**

When this item is turned on, the request switch on the door is activated. From the Vehicle Settings menu, select “I-Key Door Unlock”. Use the ENTER button to activate this function.

### **Selective-Unlock**

When this item is turned on, only the driver’s door is unlocked first after the door unlock operation. When the door handle request switch on the driver’s or front passenger’s side door is pushed to be unlocked, only the corresponding door is unlocked first. All the doors can be unlocked if the door unlock operation is performed again within 1 minute. When this item is turned to off, all the doors will be unlocked after the door unlock operation is performed once. From the Vehicle Settings menu, select “Selective Unlock”. Use the ENTER button to activate this function.

### **Answer back horn**

When the answer back horn is on, the horn will chirp and the hazard indicators will flash once when locking the vehicle with the Intelligent Key.

### **Speed Dependent**

The speed dependent feature can be set to be ON or OFF. From the Vehicle Settings menu, select “Speed Dependent”. Use the ENTER button to turn this feature ON or OFF.

## Reverse Link

The reverse link feature can be set to be ON or OFF. From the Vehicle Settings menu, select "Reverse Link". Use the ENTER button to turn this feature ON or OFF.

## Drip Wipe

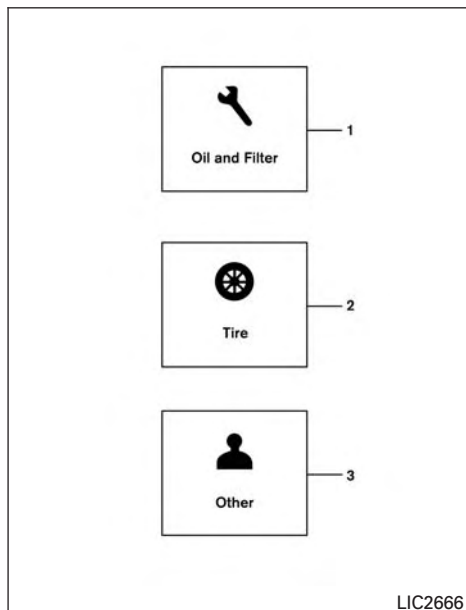

The drip wipe feature can be set to be ON or OFF. From the Vehicle Settings menu, select "Drip Wipe". Use the ENTER button to turn this feature ON or OFF.



1. scheduled service: oil and oil filter
2. tires
3. other

## Maintenance

The maintenance mode allows you to set alerts for the reminding of maintenance intervals. To change an item:

1. Press the  button.
2. Use the  button until "Settings" is selected.
3. Select "Maintenance" using the  button and press ENTER.

### Oil and Filter

This indicator appears when the customer set distance comes for changing the engine oil and filter. You can set or reset the distance for checking or replacing these items. For scheduled maintenance items and intervals, see your "NISSAN Service and Maintenance Guide."

### Tire

This indicator appears when the customer set distance is reached for replacing tires. You can set or reset the distance for replacing tires.

## WARNING



The tire replacement indicator is not a substitute for regular tire checks, including tire pressure checks. See “Changing Wheels and Tires” in “Maintenance & Do-It-Yourself” section. Many factors including tire inflation, alignment, driving habits and road conditions affect tire wear and when tires should be replaced. Setting the tire replacement indicator for a certain driving distance does not mean your tires will last that long. Use the tire replacement indicator as a guide only and always perform regular tire checks. Failure to perform regular tire checks, including tire pressure checks could result in tire failure. Serious vehicle damage could occur and may lead to a collision, which could result in serious personal injury or death.

### Other

This indicator appears when the customer set distance is reached for checking or replacing maintenance items other than the engine oil, oil filter and tires. Other maintenance items can include such things as air filter or tire rotation. The distance for checking or replacing the items can be set or reset.

### Alarm

This setting allows the customer to set alarms for outside temperature and a timer alert.

1. Press the  button.
2. Use the  button until “Settings” is selected, and press ENTER.
3. Select “Alarm” using the  button and press ENTER.



### Outside Temperature

This setting allows the customer to enable/disable the alert for low outside temperature in the vehicle information display.

1. Use the  button to select “Outside Temperature”.
2. Press the ENTER button to turn ON/OFF the outside temperature in the vehicle information display.

### Timer Alert



This setting allows the driver to set an alert to notify a set time has been reached.

1. Use the  button to select “Timer Alert”.
2. Press the ENTER button.
3. To change the timer amount, use the  button and the ENTER button to save the selected time amount.

### Unit

The units that are shown in the vehicle information display can be changed:

- Mileage
- Tire pressures
- Temperature

Use the , , and the ENTER buttons to select and change the units of the vehicle information display. The units of the navigation screen can be changed independently of the vehicle information display. For vehicles equipped with Navigation, see “System” in the “Monitor, climate, audio, phone and voice recognition systems” section of this manual.

## Mileage

The unit for the mileage that displays in the vehicle information display can be changed to:

- miles, MPG
- km/h, km/l
- km/h, l/100km

Use the  and the ENTER buttons to select and change the unit.

## Tire Pressures

The unit for tire pressure that displays in the vehicle information display can be changed to:

- psi
- kPa
- bar
- Kgf/cm<sup>2</sup>

Use the  and the ENTER buttons to select and change the unit.

## Temperature

The temperature that displays in the vehicle information display can be changed from:



- °F (Fahrenheit)
- °C (Celsius)

Use the ENTER button to toggle choices.

## Language



The language of the vehicle information display can be changed to:

- US English
- French
- Spanish

Use the , , and the ENTER buttons to select and change the language of the vehicle information display. The language of the center display/navigation can be changed independently of the vehicle information display. For vehicles not equipped with Navigation see "SETTING button:" and vehicles equipped with Navigation see, "System" in the "Monitor, climate, audio, phone and voice recognition systems" section of this manual.

## Factory Reset

The settings in the vehicle information display can be reset back to the factory default. To reset the vehicle information display:

1. Press the  button.
2. Use the  buttons to select "Settings", and press the ENTER button.

3. Select "Factory Reset" using the  buttons and press the ENTER button.

4. Select "YES" to return all settings back to default by pressing the ENTER button.



1

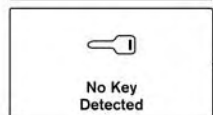

2

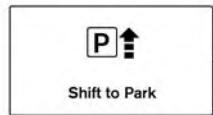

3

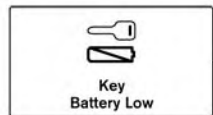

4

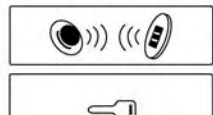

5

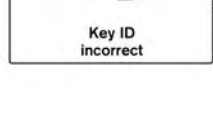

6

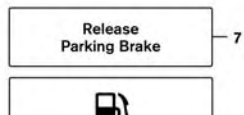

7



8

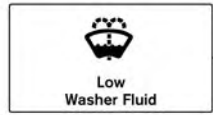

9



10

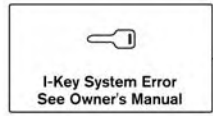

11

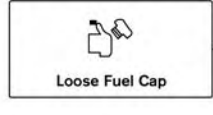

12



13



14



15

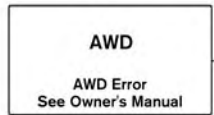

16

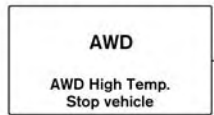

17

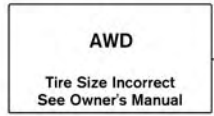

18

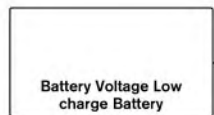

19

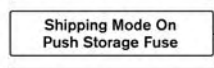

20

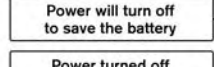

21

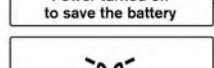

22



23



24

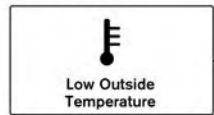

25

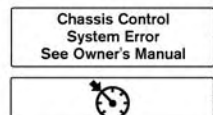

26

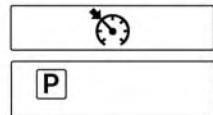

27

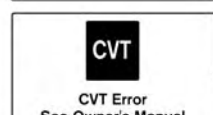

29



30

## VEHICLE INFORMATION DISPLAY WARNINGS AND INDICATORS

1. Engine start operation
2. No Key Detected
3. Shift to Park
4. Key battery low
5. Engine start operation for Intelligent Key system (if I-Key battery level is low)
6. Key ID Incorrect
7. Release parking brake
8. Low Fuel
9. Low Washer Fluid
10. Door/Liftgate Open
11. I-Key System Error: See Owner's Manual
12. Loose Fuel Cap
13. Tire Pressure Low – Add Air
14. Flat Tire – Visit Dealer
15. Low Oil Pressure Stop Vehicle
16. AWD Error: See Owner's Manual
17. AWD High Temp. Stop Vehicle

18. AWD Tire Size Incorrect See Owner's Manual
19. Battery Voltage Low Charge Battery
20. Shipping Mode On Push Storage Fuse
21. Power will turn off to save the battery
22. Power turned off to save the battery
23. Reminder: Turn OFF headlights
24. Timer Alert – Time for a driver break?
25. Low Outside Temperature
26. Chassis Control System Error: See Owner's Manual
27. Cruise Control
28. Transmission Shift Position Indicator
29. CVT Error See Owner's Manual
30. Malfunction See Owner's Manual

### Engine start operation

This indicator appears when the shift lever is in the P (Park) position.

This indicator means that the engine will start by pushing the ignition switch with the brake pedal depressed. You can start the engine in any position of the ignition switch.

### No Key Detected

This warning appears when the Intelligent Key is left outside the vehicle with the ignition switch in the ON position. Make sure the Intelligent Key is inside the vehicle.

### Shift to Park

This warning illuminates when the ignition switch is in the ACC (if so equipped) or OFF position and the shift lever is in any position other than P (Park) position. Also, a chime sounds when the ignition switch is in the OFF position.

If this warning illuminates, move the shift lever to the P (Park) position or start the engine.

For additional information about Intelligent Key, see "NISSAN Intelligent Key®" in the "Pre-driving checks and adjustments" section.

### Key Battery Low

This indicator illuminates when the Intelligent Key battery is running out of power.

If this indicator illuminates, replace the battery with a new one. See "Battery replacement" in the "Maintenance and do-it-yourself" section.

### **Engine start operation for Intelligent Key system**

This indicator appears when the battery of the Intelligent Key is low and when the Intelligent Key system and the vehicle are not communicating normally.

If this appears, touch the ignition switch with the Intelligent Key while depressing the brake pedal. For more information, see “Intelligent Key battery discharge” in the “Starting and driving” section.

### **Key ID Incorrect**

This warning appears when the ignition switch is placed from the OFF position and the Intelligent Key is not recognized by the system. You cannot start the engine with an unregistered key.

See “NISSAN Intelligent Key®” in “Pre-driving checks and adjustments” for more information.

### **Release Parking Brake**

This warning illuminates in the message area of the vehicle information display when the parking brake is set and the vehicle is driven.

### **Low Fuel**

This warning illuminates when the fuel level in the fuel tank is getting low. Refuel as soon as it is convenient, preferably before the fuel gauge reaches 0 (Empty). **There will be a small reserve of fuel in the tank when the fuel gauge needle reaches 0 (Empty).**

### **Low Washer Fluid**

This warning illuminates when the windshield-washer fluid is at a low level. Add windshield-washer fluid as necessary. See “Windshield-washer fluid” in the “Maintenance and do-it-yourself” section of this manual.

### **Door Open**

This warning illuminates when a door has been opened when the engine is running.

### **Intelligent Key error**

After the ignition switch is pushed to the ON position, this light comes on for about 2 seconds and then turns off.

The I-Key System Error message warns of a malfunction with the Intelligent Key system. If the light comes on while the engine is stopped, it may be impossible to start the engine.

If the light comes on while the engine is running, you can drive the vehicle. However in these cases, contact a NISSAN dealer for repair as soon as possible.

### **Loose Fuel Cap**

This warning appears when the fuel-filler cap is not tightened correctly after the vehicle has been refueled. See “Fuel-filler cap” in the “Pre-driving checks and adjustments” section of this manual.

### **Tire Pressure Low - Add Air warning**

This warning appears when the low tire pressure warning light in the meter illuminates and low tire pressure is detected. If this warning appears, stop the vehicle and adjust the tire pressures of all 4 tires to the recommended COLD tire pressure shown on the Tire and Loading Information label. See “Low tire pressure warning light” earlier in this section and “Tire Pressure Monitoring System (TPMS)” in the “Starting and driving” section.

### **Flat Tire – Visit dealer**

This warning appears when the low tire pressure warning light in the meter illuminates and one or more flat tires are detected while driving. A chime also sounds for approximately 10 seconds.

### **Low Oil Pressure Stop Vehicle**

This warning appears in message area of the vehicle information display if low oil pressure is detected. This gauge is not designed to indicate low oil level. **The low oil pressure warning is not designed to indicate a low oil level.** Use the dipstick to check the oil level. See “Engine oil” in the “Maintenance and do-it-yourself” section.

### **All-Wheel Drive (AWD) Error See Owner’s Manual (if so equipped)**

This warning appears when the all-wheel drive system is not functioning properly while the engine is running.

### **All-Wheel Drive (AWD) High Temp. Stop Vehicle (if so equipped)**

This warning may appear while trying to free a stuck vehicle due to increased oil temperature. The driving mode may change to Two-Wheel Drive (2WD). If this warning is displayed, stop the vehicle with the engine idling, as soon as it is safe to do so. Then if the warning turns off, you can continue driving.

### **All-Wheel Drive (AWD) Tire Size Incorrect See Owner’s Manual (if so equipped)**

This warning may appear if there is a large difference between the diameters of the front and rear wheels. Pull off the road in a safe area, with the engine idling. Check that all the tire sizes are the same, that the tire pressure is correct and that the tires are not excessively worn.

### **Battery Voltage Low Charge Battery**

This warning appears when the battery is low and needs to be charged.

### **Extended storage fuse**

This warning may appear if the extended storage fuse switch is not pushed in (switched on). When this warning appears, push in (switch on) the extended storage fuse switch to turn off the warning. Refer to “Fuses” in “Maintenance and do-it-yourself” for more information.

### **Power will turn off to save the battery**

This warning appears in message area of the vehicle information display after a period of time if the shift lever has not moved from the P (Park) position.

### **Power turned off to save the battery**

This warning appears after the ignition switch is automatically turned off to save the battery.

### **Reminder: Turn OFF headlights**

This warning appears when the headlights are left in the ON position when exiting the vehicle. Place the headlight switch in the OFF or AUTO position. For additional information, see “Headlight and turn signal switch” in this section.

### **Timer Alert – Time for a driver break?**

This indicator appears when the set time is reached. The time can be set up to 6 hours. For setting the timer, see “Timer alert” in this section.

### **Low Outside Temperature**

This warning appears if the outside temperature is below 37°F (3°C). The temperature can be changed to display in Celsius or Fahrenheit. See “Temperature” earlier in this section.

### **Chassis control error**

This warning appears if the chassis control module detects an error in the chassis control system. Have the system checked by a NISSAN dealer. See “Chassis Controls” in “Starting and Driving” for more information.



## SECURITY SYSTEMS

### Cruise indicators

This indicator shows the cruise control system status.

When cruise control is activated, a green circle will illuminate to indicate it is set. The vehicle information display will also display the speed the cruise control was set at. If you accelerate past the set speed, the speed will blink until you either cancel cruise control or go back to the set speed. If cruise control is on and cancelled, the speed will be displayed to show the speed the vehicle will return to if the resume button is activated.

### Transmission position indicator

This indicator shows the transmission shift position.

### CVT Error: See Owner's Manual

This warning illuminates when there is a problem with the CVT system. If this warning comes on, have the system checked by a NISSAN dealer.

### Malfunction See Owner's Manual

This warning appears when the Blind Spot Warning/Lane Departure Warning or Forward Collision Warning systems are not functioning properly.

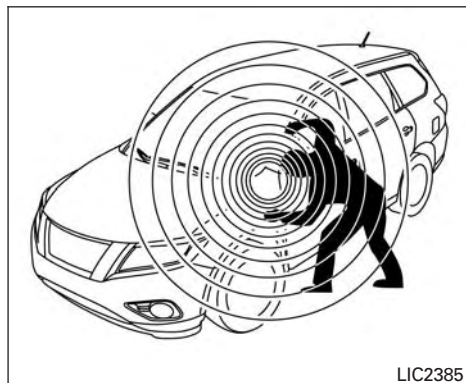

Your vehicle may have two types of security systems:

- Vehicle security system
- NISSAN Vehicle Immobilizer System

### VEHICLE SECURITY SYSTEM

The vehicle security system provides visual and audible alarm signals if someone opens the doors, trunk lid or the hood when the system is armed. It is not, however, a motion detection type system that activates when a vehicle is moved or when a vibration occurs.

The system helps deter vehicle theft but cannot prevent it, nor can it prevent the theft of interior or exterior vehicle components in all situations. Always secure your vehicle even if parking for a brief period. Never leave your Intelligent Key in the vehicle, and always lock the vehicle when unattended. Be aware of your surroundings, and park in secure, well-lit areas whenever possible.

Many devices offering additional protection, such as component locks, identification markers, and tracking systems, are available at auto supply stores and specialty shops. Your NISSAN dealer may also offer such equipment. Check with your insurance company to see if you may be eligible for discounts for various theft protection features.

### How to arm the vehicle security system

1. Close all windows. **(The system can be armed even if the windows are open.)**
2. Remove the Intelligent Key from the vehicle.
3. Close all doors, hood and trunk/liftgate. Lock all doors. The doors can be locked with the Intelligent Key, door handle request switch (if so equipped), power door lock switch or mechanical key.

4. Confirm that the security indicator light comes on. The security light stays on for about 30 seconds. The vehicle security system is now pre-armed. After about 30 seconds the vehicle security system automatically shifts into the armed phase. The security light begins to flash once every 3 seconds. If, during the 30-second pre-arm time period, the driver's door is unlocked by the key or the keyfob, or the ignition switch is placed in the ACC (if so equipped) or ON position, the system will not arm.
- **Even when the driver and/or passengers are in the vehicle, the system will activate with all the doors, hood and trunk lid locked with the ignition switch placed in the LOCK position. When placing the ignition switch in the ACC (if so equipped) or ON position, the system will be released.**

### Vehicle security system activation

The vehicle security system will give the following alarm:

- The headlights blink and the horn sounds intermittently.

- The alarm automatically turns off after a period of time. However, the alarm reactivates if the vehicle is tampered with again. The alarm can be shut off by unlocking the driver's door with the key, or by pressing the  button on the Intelligent Key.

The alarm is activated by:

- opening the door or hood without using the key or Intelligent Key (even if the door is unlocked by releasing the door inside lock switch).

### How to stop an activated alarm

The alarm stops only by unlocking the driver's door or the trunk/liftgate with the key, pressing the  button on the Intelligent Key, or pressing the request switch on the driver's or passenger's door with the Intelligent Key in range of the door handle.

### NISSAN VEHICLE IMMOBILIZER SYSTEM

The NISSAN Vehicle Immobilizer System will not allow the engine to start without the use of a registered key.

**Never leave these keys in the vehicle.**

### FCC Notice:

#### For USA:

**This device complies with part 15 of the FCC Rules. Operation is subject to the following two conditions: (1) This device may not cause harmful interference, and (2) this device must accept any interference received, including interference that may cause undesired operation.**

#### NOTE:

**Changes or modifications not expressly approved by the party responsible for compliance could void the user's authority to operate the equipment.**

#### For Canada:

**This device complies with Industry Canada license-exempt RSS standard(s). Operation is subject to the following two conditions: (1) this device may not cause harmful interference, and (2) this device must accept any interference received, including interference that may cause undesired operation of the device.**

## WINDSHIELD WIPER AND WASHER SWITCH

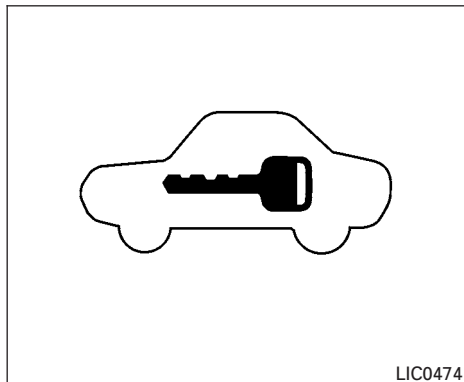

### Security indicator light

The security indicator light blinks whenever the ignition switch is placed in the OFF, LOCK or ACC (if so equipped) position. This function indicates the NISSAN Vehicle Immobilizer System is operational.

If the NISSAN Vehicle Immobilizer System is malfunctioning, the light will remain on while the ignition switch is placed in the ON position.

**If the light still remains on and/or the engine will not start, see a NISSAN dealer for NISSAN Vehicle Immobilizer System service as soon as possible. Please bring all registered keys that you have when visiting your NISSAN dealer for service.**

### WARNING

**In freezing temperatures the washer solution may freeze on the window and obscure your vision which may lead to an accident. Warm the window with the defroster before you wash the window.**

### CAUTION

- Do not operate the washer continuously for more than 30 seconds.
- Do not operate the washer if the reservoir tank is empty.
- Do not fill the window washer reservoir with washer fluid concentrates at full strength. Some methyl alcohol based washer fluid concentrates may permanently stain the grille if spilled while filling the window washer reservoir.
- Pre-mix washer fluid concentrates with water to the manufacturer's recommended levels before pouring the fluid into the window washer reservoir. Do not use the window washer reservoir to mix the washer fluid concentrate and water.

If the windshield wiper operation is interrupted by snow or ice, the wiper may stop moving to protect its motor. If this occurs, turn the wiper switch to the OFF position and remove the snow or ice that is on and around the wiper arms. In approximately 1 minute, turn the switch on again to operate the wiper.

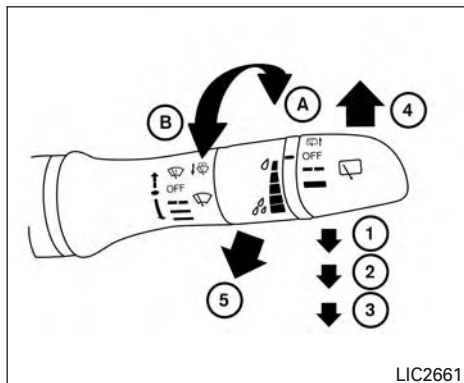

Push the lever up ④ to have one sweep operation (MIST) of the wiper.

Pull the lever toward you ⑤ to operate the washer. The wiper will also operate several times.

## SWITCH OPERATION

The windshield wiper and washer operates when the ignition switch is in the ON position.

Push the lever down to operate the wiper at the following speed:

- ① Intermittent (INT) — intermittent operation can be adjusted by turning the knob toward **A** (Slower) or **B** (Faster).
- ② Low (LO) — continuous low speed operation
- ③ High (HI) — continuous high speed operation

## REAR WINDOW WIPER AND WASHER SWITCH

### **⚠ WARNING**

**In freezing temperatures the washer solution may freeze on the window and obscure your vision. Warm the rear window with the defroster before you wash the rear window.**

### **⚠ CAUTION**

- Do not operate the washer continuously for more than 30 seconds.
- Do not operate the washer if the reservoir is empty.
- Do not fill the windshield-washer fluid reservoir with washer fluid concentrates at full strength. Some methyl alcohol based washer fluid concentrates may permanently stain the grille if spilled while filling the windshield-washer fluid reservoir.
- Pre-mix washer fluid concentrates with water to the manufacturer's recommended levels before pouring the fluid into the windshield-washer fluid reservoir. Do not use the windshield-washer fluid reservoir to mix the washer fluid concentrate and water.

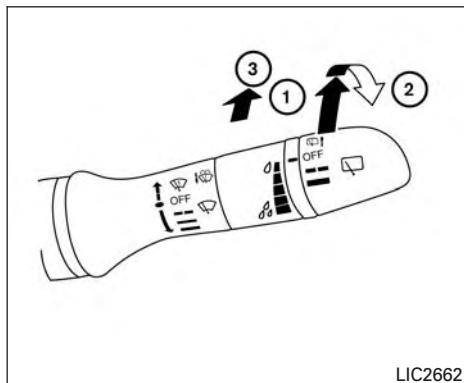

LIC2662

Push the switch forward ③ to operate the washer. The wiper will also operate several times.

If the rear window wiper operation is interrupted by snow, etc., the wiper may stop moving to protect its motor. If this occurs, turn the wiper switch to OFF and remove the snow, etc. on and around the wiper arms. After about 1 minute, turn the switch ON again to operate the wiper.

The rear window wiper and washer operate when the ignition switch is in the ON position. Turn the switch clockwise from the OFF position to operate the wiper.

- ① Intermittent (INT) — intermittent operation (not adjustable)
- ② Low (ON) — continuous low speed operation

## 2-34 Instruments and controls

## REAR WINDOW AND OUTSIDE MIRROR (if so equipped) DEFROSTER SWITCH

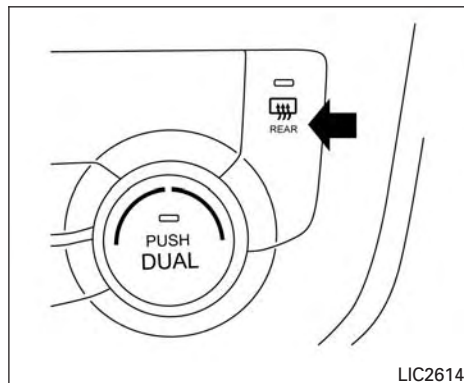

LIC2614

To defrost the rear window glass and outside mirrors (if so equipped), start the engine and push the rear window defroster switch on. The rear window defroster indicator light on the switch comes on. Push the switch again to turn the defroster off.

The rear window defroster automatically turns off after approximately 15 minutes.

### CAUTION

**When cleaning the inner side of the rear window, be careful not to scratch or damage the rear window defroster.**

## HEADLIGHT AND TURN SIGNAL SWITCH

### NOTE:

The top and bottom few rows of wires on the rear window are not part of the rear window defroster system. These wires make up the antenna for the audio system.

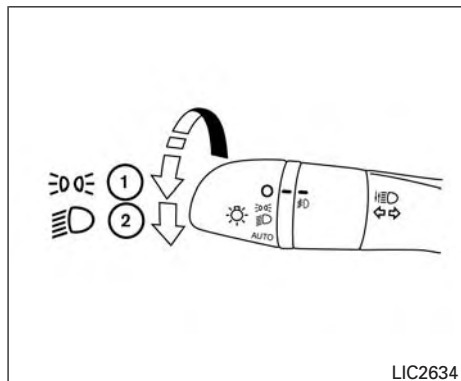

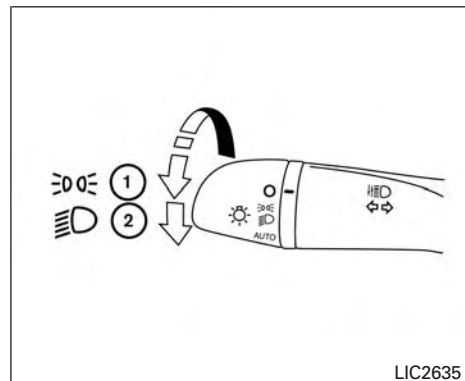

Type A



Type B

## HEADLIGHT CONTROL SWITCH

### Lighting

- ① When turning the switch to the  position, the front parking, tail, license plate and instrument panel lights come on.
- ② When turning the switch to the  position, the headlights come on and all the other lights remain on.

### CAUTION

Use the headlights with the engine running to avoid discharging the vehicle battery.

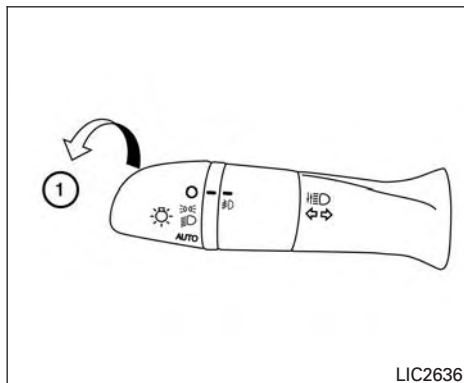

## Autolight system

The autolight system allows the headlights to turn on and off automatically. The autolight system can:

- Turn on the headlights, front parking, tail, license plate and instrument panel lights automatically when it is dark.
- Turn off all the lights when it is light.
- Keep all the lights on for a period of time after you place the ignition switch in the OFF position and all doors are closed.



### NOTE:

**Autolight activation sensitivity and the time delay for autolight shutoff can be adjusted. See “Vehicle information display” in this section.**

To turn on the autolight system:

1. Turn the headlight switch to the AUTO position ①.
2. Turn the ignition switch to ON.
3. The autolight system automatically turns the headlights on and off.

Initially, if the ignition switch is turned OFF and a door is opened and left open, the headlights remain ON for a period of time. If another door is opened while the headlights are on, then the timer is reset.

To turn the autolight system off, turn the switch to the OFF, , or  position.

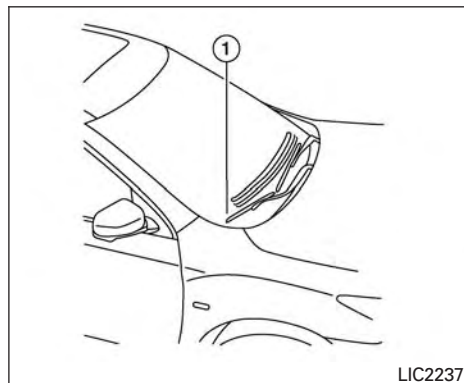

**Be sure you do not put anything on top of the autolight sensor located in the top side ① of the instrument panel. The autolight sensor controls the autolight; if it is covered, the autolight sensor reacts as if it is dark out and the headlights will illuminate. If this occurs while parked with the engine off and the ignition switch placed in the ON position, your vehicle's battery could become discharged.**

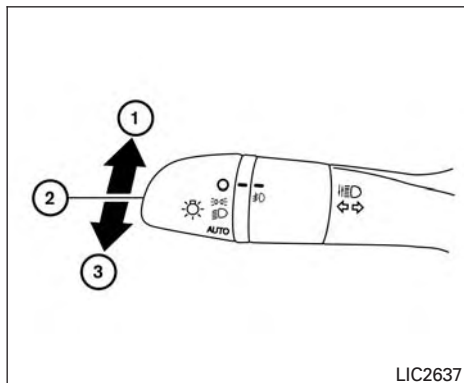

LIC2637



### Headlight beam select

- ① To select the high beam function, push the lever forward. The high beam lights come on and the  light illuminates.
- ② Pull the lever back to select the low beam.
- ③ Pulling and releasing the lever flashes the headlight high beams on and off.

### Battery saver system

The battery saver automatically turns off the ignition after a period of time when the ignition switch is left in the ACC (if so equipped) or ON position.

### DAYTIME RUNNING LIGHT SYSTEM

The daytime running lights automatically illuminate when the engine is started with the parking brake released. The daytime running lights operate with the headlight switch in the OFF position or in the  position. Turn the headlight switch to the  position for full illumination when driving at night.

If the parking brake is applied before the engine is started, the daytime running lights do not illuminate. The daytime running lights illuminate when the parking brake is released. The daytime running lights will remain on until the ignition switch is placed in the OFF position.

### WARNING

**When the daytime running light system is active, tail lights on your vehicle are not on. It is necessary at dusk to turn on your headlights. Failure to do so could cause an accident injuring yourself and others.**

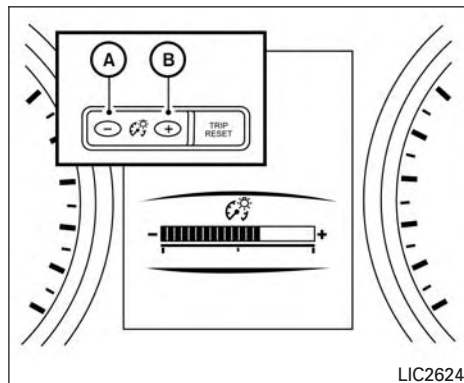

LIC2624

### INSTRUMENT BRIGHTNESS CONTROL

Push the “-” button (A) to decrease the brightness of instrument panel lights when driving at night.

Push the “+” button (B) to increase the brightness of instrument panel lights when driving at night.



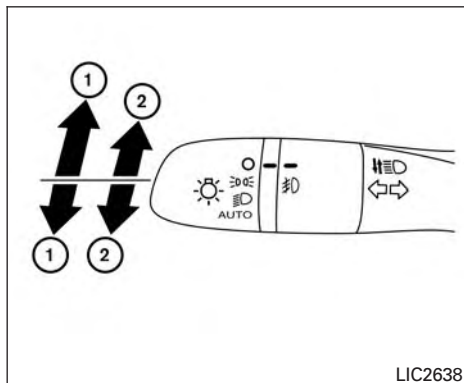

LIC2638

## TURN SIGNAL SWITCH

### Turn signal

- ① Move the lever up or down to signal the turning direction. When the turn is completed, the turn signal cancels automatically.

### Lane change signal

- ② To signal a lane change, move the lever up or down to the point where the indicator light begins to flash, but the lever does not latch.

The turn signal will flash three times automatically.

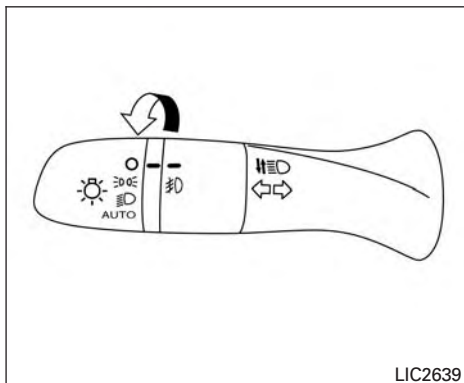

LIC2639

## FOG LIGHT SWITCH (if so equipped)

To turn the fog lights on, turn the headlight switch to the position, then turn the fog light switch to the position.

To turn the fog lights on with the headlight switch in the AUTO position, the headlights must be on, then turn the fog light switch to the position.

To turn the fog lights off, turn the fog light switch to the OFF position.

The headlights must be on and the low beams selected for the fog lights to operate. The fog lights automatically turn off when the high beam headlights are selected.

## HORN

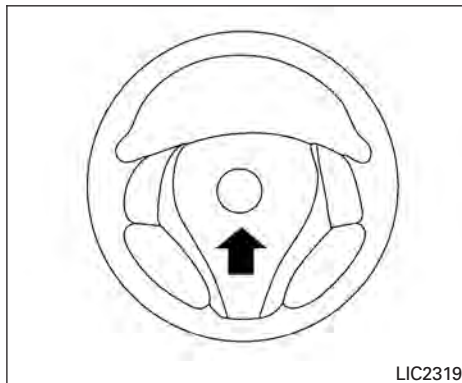

LIC2319

To sound the horn, push near the horn icon on the steering wheel.

### WARNING

**Do not disassemble the horn. Doing so could affect proper operation of the supplemental front air bag system. Tampering with the supplemental front air bag system may result in serious personal injury.**

## HEATED SEATS (if so equipped)

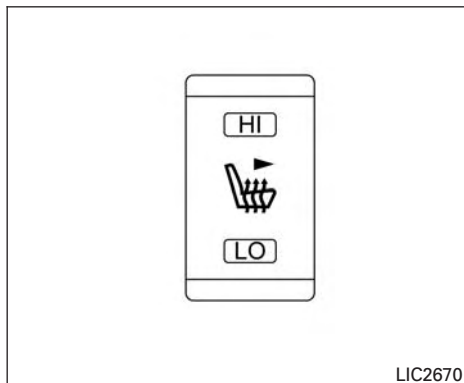

The front seats are warmed by built-in heaters.

1. Start the engine.
2. Push the LO or HI position of the switch, as desired. The indicator light in the switch will illuminate.

The heater is controlled by a thermostat, automatically turning the heater on and off. The indicator light will remain on as long as the switch is on.

3. When the seat is warmed or before you leave the vehicle, be sure to turn the switch off.

### WARNING

Do not use or allow occupants to use the seat heater if you or the occupants cannot monitor elevated seat temperatures or have an inability to feel pain in body parts that contact the seat. Use of the seat heater by such people could result in serious injury.

### CAUTION

- The battery could run down if the seat heater is operated while the engine is not running.
- Do not use the seat heater for extended periods or when no one is using the seat.
- Do not put anything on the seat which insulates heat, such as a blanket, cushion, seat cover, etc. Otherwise, the seat may become overheated.
- Do not place anything hard or heavy on the seat or pierce it with a pin or similar object. This may result in damage to the heater.
- Any liquid spilled on the heated seat should be removed immediately with a dry cloth.

- When cleaning the seat, never use gasoline, benzine, thinner, or any similar materials.
- If any malfunctions are found or the heated seat does not operate, turn the switch off and have the system checked by your NISSAN dealer.

## VEHICLE DYNAMIC CONTROL (VDC) OFF SWITCH

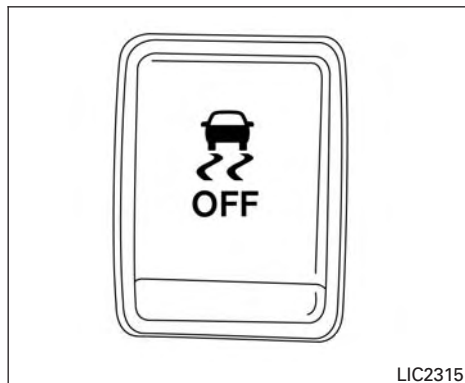

The vehicle should be driven with the Vehicle Dynamic Control (VDC) system on for most driving conditions.

If the vehicle is stuck in mud or snow, the VDC system reduces the engine output to reduce wheel spin. The engine speed will be reduced even if the accelerator is depressed to the floor. If maximum engine power is needed to free a stuck vehicle, turn the VDC system off.

To turn off the VDC system, push the VDC OFF switch. The  indicator will come on.

Push the VDC OFF switch again or restart the engine to turn on the system. See "Vehicle Dynamic Control (VDC) system" in the "Starting and driving" section.

## 2-40 Instruments and controls

## ALL-WHEEL DRIVE (AWD) LOCK SWITCH (if so equipped)

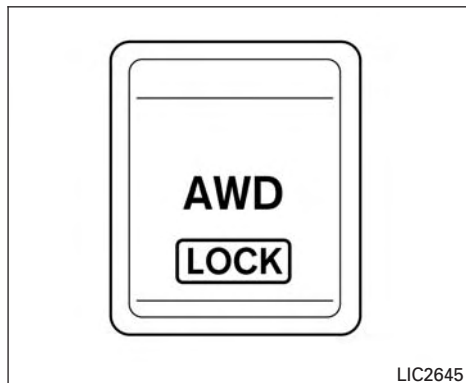

The all-wheel drive (AWD) lock switch is located on the instrument panel. The AWD LOCK indicator light will illuminate when the switch is turned on. Refer to "Warning/Indicator lights" in this section for more information.

Each time you push the switch, the AWD mode will switch: AUTO → LOCK → AUTO.

## SPORT MODE SWITCH (if so equipped)

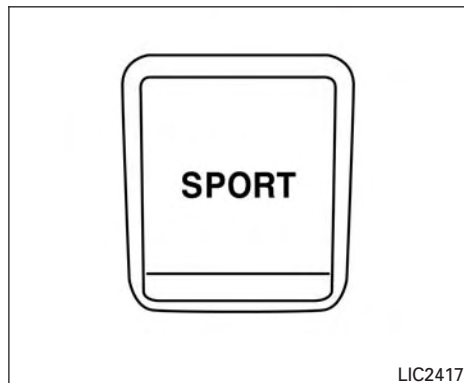

Adjusts the engine and transmission points to enhance performance. Press the SPORT button on the instrument panel to activate. "SPORT" appears in the speedometer for 2 seconds.

### NOTE:

**In the SPORT mode, fuel economy may be reduced.**

## HILL DESCENT SWITCH (if so equipped)



LIC2664

### **⚠ WARNING**

- **Never rely solely on the hill descent control system to control vehicle speed when driving on steep downhill grades. Always drive carefully when using the hill descent control system and decelerate the vehicle speed by depressing the brake pedal if necessary. Be especially careful when driving on frozen, muddy or extremely steep downhill roads. Failure to control vehicle speed may result in a loss of control of the vehicle and possible serious injury or death.**

- **The hill descent control may not control the vehicle speed on a hill under all load or road conditions. Always be prepared to depress the brake pedal to control vehicle speed. Failure to do so may result in a collision or serious personal injury.**

### **⚠ CAUTION**

**When the hill descent control system operates continuously for a long time, the temperature of the brake pads may increase and the hill descent control system may be temporarily disabled (the indicator light will blink). If the indicator light does not come on continuously after blinking, stop using the system.**

The hill descent control system is designed to reduce driver workload when going down steep hills. The hill descent control system helps to control vehicle speed so the driver can concentrate on steering the vehicle.

To activate the hill descent control system:

- the transmission shift lever must be in forward or reverse gear,
- the hill descent control system switch must be ON.

The hill descent control indicator light will come on when the system is activated. Also, the stop/tail lights illuminate while the hill descent control system applies the brakes to control vehicle speed.

If the accelerator or brake pedal is depressed while the hill descent control system is on, the system will stop operating temporarily. As soon as the accelerator or brake pedal is released, the hill descent control system begins to function again if the hill descent control operating conditions are fulfilled.

The hill descent control indicator light blinks if the switch is on and all conditions for system activation are not met or if the system becomes disengaged for any reason.

To turn off the hill descent control system, push the switch to the OFF position.

For additional information, see “Hill descent control system on indicator light” earlier in this section and “Hill descent control system” in the “Starting and driving” section of this manual.

## WARNING SYSTEMS SWITCH (if so equipped)

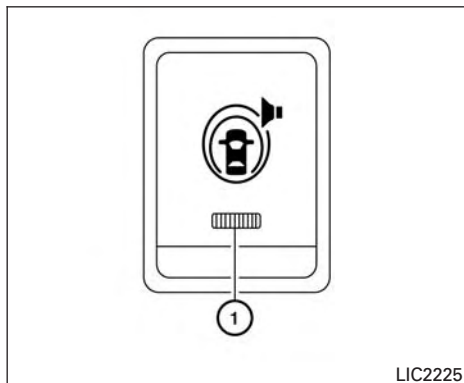

The warning systems switch is used to turn on and off the warning systems (Lane Departure Warning (LDW) and Blind Spot Warning (BSW) systems) that are activated using the settings menu on the vehicle information display.

When the warning systems switch is turned off, the indicator ① on the switch is off. The indicator will also be off if all of the warning systems are deactivated using the settings menu.

The LDW system will sound a warning chime and blink the LDW indicator light (orange) to alert the driver if the vehicle is traveling close to either the left or the right of a traveling lane with detectable

lane markers. See “Lane Departure Warning (LDW) system” in the “Starting and driving” section.

The BSW system will turn on the BSW indicator light, located next to the outside mirrors, if the camera detects a vehicle in the detection zone. If the turn signal is activated in the direction of the detected vehicle, a chime sounds twice and the BSW indicator light will flash. See “Blind Spot Warning (BSW) system” in the “Starting and driving” section.

## POWER OUTLETS

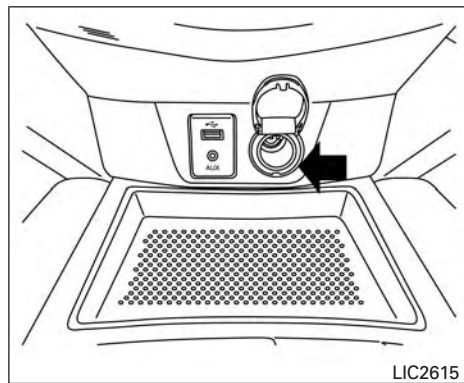

### Instrument Panel

## 12V OUTLETS

The power outlets are for powering electrical accessories such as cellular telephones. They are rated at 12 volt, 120W (10A) maximum.

The front and center console power outlets are powered only when the ignition switch is in the ACC (if so equipped) or ON position.

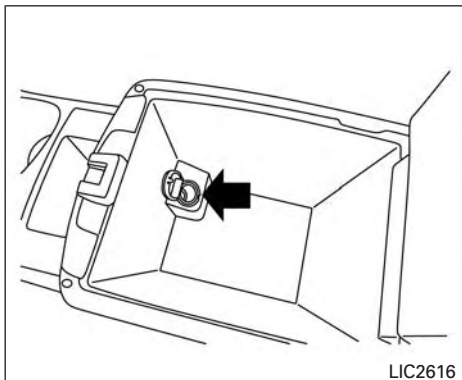

**Center Console**

**⚠ CAUTION**

- The outlet and plug may be hot during or immediately after use.
- Only certain power outlets are designed for use with a cigarette lighter unit. Do not use any other power outlet for an accessory lighter. See your NISSAN dealer for additional information.
- Do not use with accessories that exceed a 12 volt, 120W (10A) power draw.
- Do not use double adapters or more than one electrical accessory.

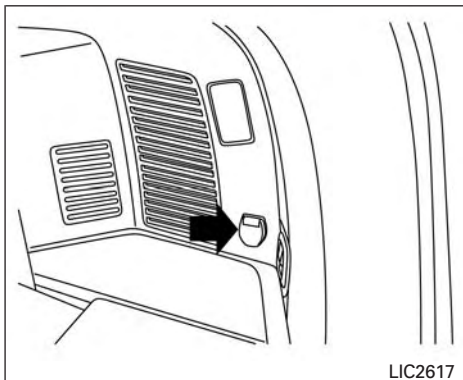

**Cargo Area**

- Use power outlets with the engine running to avoid discharging the vehicle battery.
- Avoid using power outlets when the air conditioner, headlights or rear window defroster is on.
- Before inserting or disconnecting a plug, be sure the electrical accessory being used is turned OFF.

- Push the plug in as far as it will go. If good contact is not made, the plug may overheat or the internal temperature fuse may open.
- When not in use, be sure to close the cap. Do not allow water or any other liquid to contact the outlet.

## STORAGE

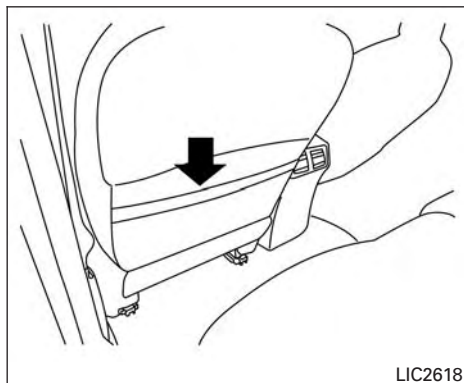

### SEATBACK POCKETS

There are two seatback pockets located on the back of the driver and passenger seats. The pockets can be used to store maps.

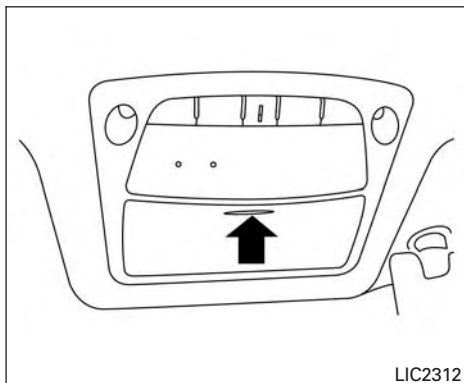

### SUNGLASSES HOLDER

To open the sunglasses holder ①, push and release.

Only store one pair of sunglasses in the holder.

#### CAUTION

- Do not use for anything other than sunglasses.
- Do not leave sunglasses in the sunglasses holder while parking in direct sunlight. The heat may damage the sunglasses.

#### WARNING

**Keep the sunglasses holder closed while driving to prevent an accident.**

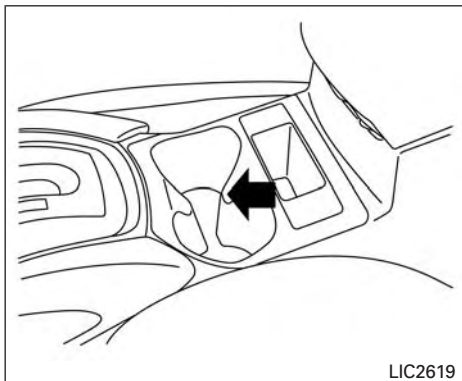

**Front console**

## CUP HOLDERS

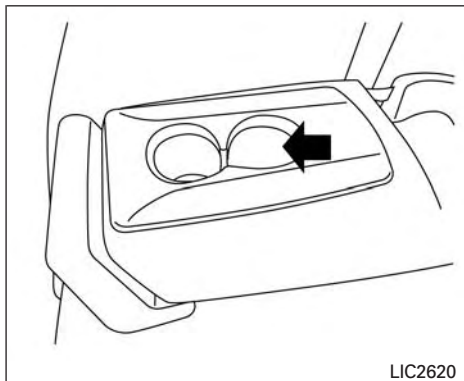

**Bench seat**

### **⚠ CAUTION**

- Avoid abrupt starting and braking when the cup holder is being used to prevent spilling the drink. If the liquid is hot, it can scald you or your passenger.
- Use only soft cups in the cup holder. Hard objects can injure you in an accident.

### **⚠ CAUTION**

**Do not recline the rear seatback when you use the cup holders on the rear armrest. Doing so may cause the beverages to spill over, and if they are hot, they may scald the passengers.**



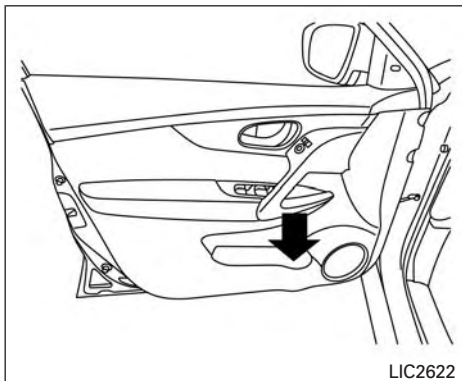

**Bottle holder — front**

**⚠ CAUTION**

- Do not use bottle holder for any other objects that could be thrown about in the vehicle and possibly injure people during sudden braking or an accident.
- Do not use bottle holder for open liquid containers.

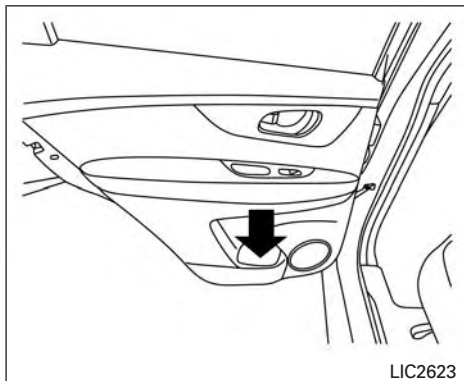

**Bottle holder — rear**

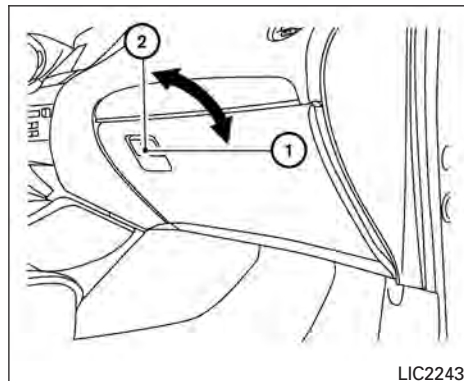

**GLOVE BOX**

Open the glove box by pulling the handle. Use the master key when locking ① or unlocking ② the glove box.

**⚠ WARNING**

**Keep glove box lid closed while driving to help prevent injury in an accident or a sudden stop.**

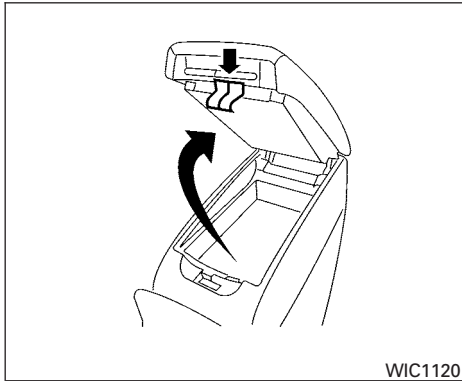

## CONSOLE BOX

### Upper half

Pull up on the driver's side latch to open the upper half of the console box.

The upper half of the console box may be used for storage of cellular phones. An access hole is provided at the front of the upper half of the console box for a phone or iPod® cord routing to the power outlet.

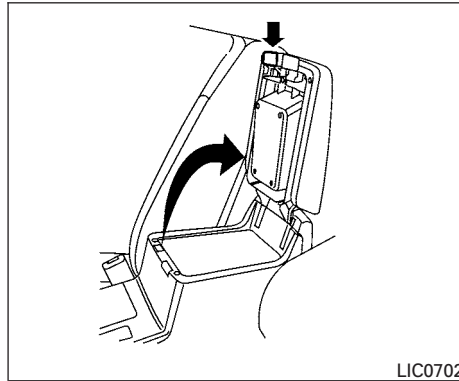

### Lower half

Pull up on the passenger's side latch to open the lower half of the console box. A power outlet is located inside the console box and there is storage for compact discs.

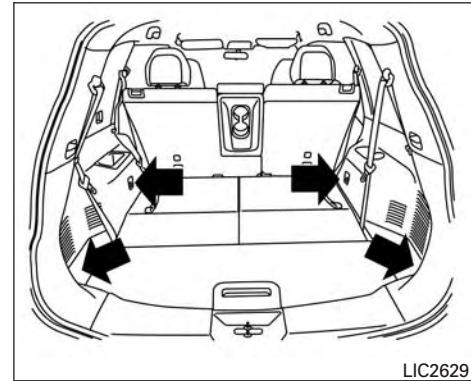

## LUGGAGE HOOKS

When securing items using luggage hooks located on the back of the seat or side finisher do not apply a load over more than 6.5 lbs (29 N) to a single hook.

The luggage hooks that are located on the floor should have loads less than 110 lbs (490 N) to a single hook.

The luggage hooks can be used to secure cargo with ropes or other types of straps.

## **⚠ WARNING**

- Properly secure all cargo with ropes or straps to help prevent it from sliding or shifting. Do not place cargo higher than the seatbacks. In a sudden stop or collision, unsecured cargo could cause personal injury.
- Use suitable ropes and hooks to secure cargo.
- Never allow anyone to ride in the luggage area. It is extremely dangerous to ride in a cargo area inside of a vehicle. In a collision, people riding in these areas are more likely to be seriously injured or killed.
- Do not allow people to ride in any area of your vehicle that is not equipped with seats and seat belts.
- The child restraint top tether strap may be damaged by contact with items in the cargo area. Secure any items in the cargo area. Your child could be seriously injured or killed in a collision if the top tether strap is damaged.
- Be sure everyone in your vehicle is in a seat and using a seat belt properly.

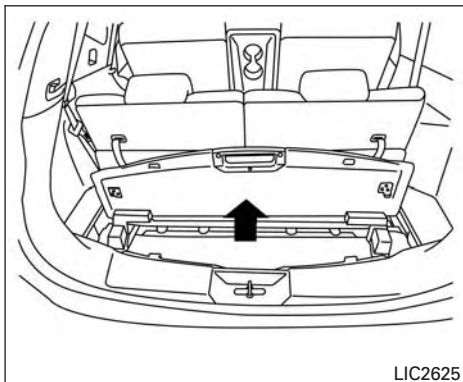

### **CARGO AREA STORAGE BIN**

To access the floor storage area, pull up on the handle to lift the luggage board.

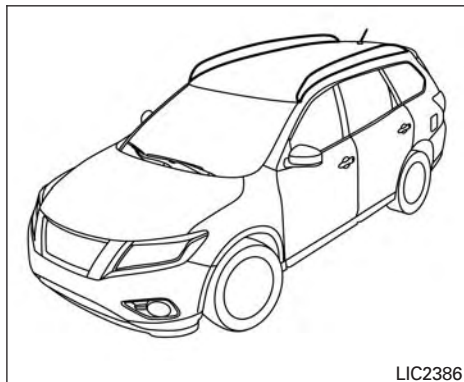

### **ROOF RACK (if so equipped)**

Genuine NISSAN accessory cross bars are available through your NISSAN dealer. Contact an NISSAN dealer for crossbar or other equipment information.

Always distribute the luggage evenly on the cross bars. Do not load more than 150 lb (68 kg) on the cross bars. Observe the maximum load limit shown on the cross bars or roof carriers when you attach them on the roof cross bars. Contact an NISSAN dealer for crossbar or other equipment information.

Do not apply any load directly to the roof side rails. Cross bars must be installed before applying load/cargo/luggage to the roof of the vehicle.

Be careful that your vehicle does not exceed the Gross Vehicle Weight Rating (GVWR) or its Gross Axle Weight Rating (GAWR front and rear). The GVWR and GAWR are located on the F.M.V.S.S. or C.V.M.S.S. certification label (located on the driver's door pillar). For more information regarding GVWR and GAWR, see "Vehicle loading information" in the "Technical and customer information" section.

#### **⚠ WARNING**

- **Drive extra carefully when the vehicle is loaded at or near the cargo carrying capacity, especially if the significant portion of that load is carried on the cross bars.**
- **Heavy loading of the cross bars has the potential to affect the vehicle stability and handling during sudden or unusual handling maneuvers.**
- **Roof rack cross bars should be evenly distributed.**
- **Do not exceed maximum roof rack cross bars load.**

- **Properly secure all cargo with ropes or straps to help prevent it from sliding or shifting. In a sudden stop or collision, unsecured cargo could cause personal injury.**

#### **⚠ CAUTION**

**Always install the cross bars onto the roof side rails before loading cargo of any kind. Loading cargo directly onto the roof side rails or the vehicle's roof may cause vehicle damage.**

**DIVIDE-N-HIDE® ADJUSTABLE FLOOR (if so equipped)**

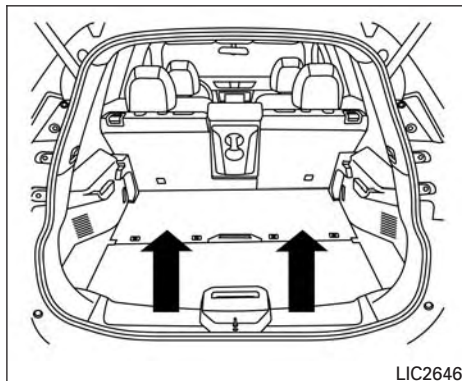

#### **⚠ WARNING**

**Do not put objects heavier than 165 lbs (75 kg) on the Divide-N-Hide® while in the mid position. In the upper position, objects should not weigh more than 30 lbs (14 kg).**

**There are multiple positions for the adjustable floor. The upper position allows for additional storage below the adjustable floor.**

## WINDOWS

### POWER WINDOWS

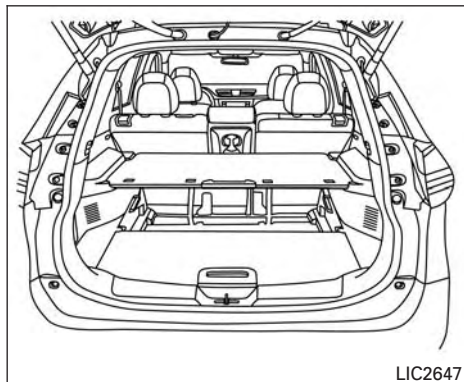

**To move the adjustable floor from the lower position to the upper position:**

1. Use the handle to lift the adjustable floor.
2. Move the adjustable floor to the upper guide track and ensure it is secure in place.

#### WARNING

- **Make sure that all passengers have their hands, etc. inside the vehicle while it is in motion and before closing the windows. Use the window lock switch to prevent unexpected use of the power windows.**
- **Do not leave children unattended inside the vehicle. They could unknowingly activate switches or controls and become trapped in a window. Unattended children could become involved in serious accidents.**

The power windows operate when the ignition switch is placed in the ON position, or for a period of time after the ignition switch is placed in the OFF position. If the driver's or passenger's door is opened during this period of time, the power to the windows is canceled.

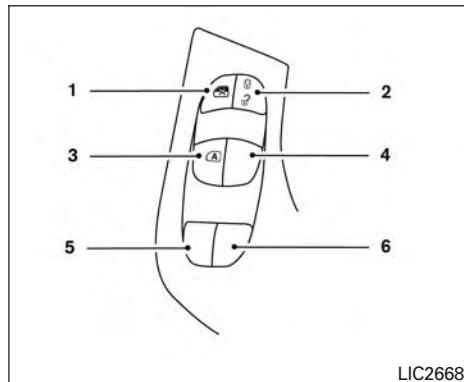

1. Window lock button
2. Power door lock switch
3. Driver side automatic switch
4. Front passenger side switch
5. Left rear passenger side switch
6. Right rear passenger side switch

## Driver's side power window switch

The driver's side control panel is equipped with switches to open or close all of the windows.

To open a window, push the switch to the first detent and continue to hold down until the desired window position is reached. To close a window, pull the switch to the first detent and continue to hold up until the desired window position is reached.

## Locking passengers' windows

When the window lock button is depressed, only the driver's side window can be opened or closed. Push it again to cancel the window lock function.

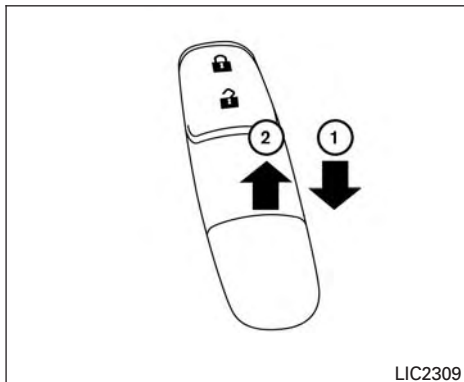

## Front passenger's power window switch

The passenger's window switch operates only the corresponding passenger's window. To open the window partially, push the switch down ① lightly until the desired window position is reached. To close the window partially, pull the switch up ② until the desired window position is reached.

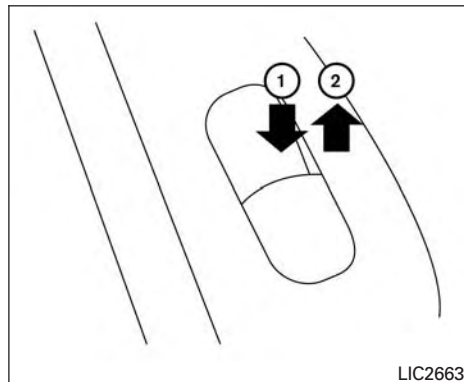

## Rear power window switch

The rear power window switches open or close only the corresponding windows. To open the window, push the switch and hold it down ①. To close the window, pull the switch up ②.

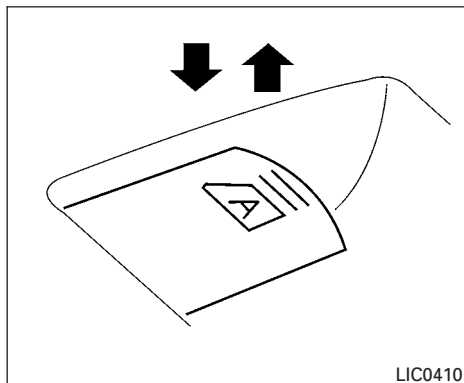

LIC0410

### Automatic operation

To fully open a window, press the window switch down to the second detent and release it; it need not be held. The window automatically opens all the way. To stop the window, lift the switch up while the window is opening.

To fully close a window, pull the switch up to the second detent and release it; it need not be held. To stop the window, press the switch down while the window is closing.

### Auto-reverse function

The auto-reverse function can be activated when a window is closed by automatic operation.

Depending on the environment or driving conditions, the auto-reverse function may be activated if an impact or load similar to something being caught in the window occurs.

### **⚠ WARNING**

**There are some small distances immediately before the closed position which cannot be detected. Make sure that all passengers have their hands, etc., inside the vehicle before closing the window.**

If the vehicle's battery is disconnected, replaced, or jump started, the power window auto-reverse function may not operate properly. If this occurs, please contact the dealer to re-initialize the power window auto-reverse system.

If the control unit detects something caught in a window equipped with automatic operation as it is closing, the window will be immediately lowered.

## POWER PANORAMIC SUNROOF (if so equipped)

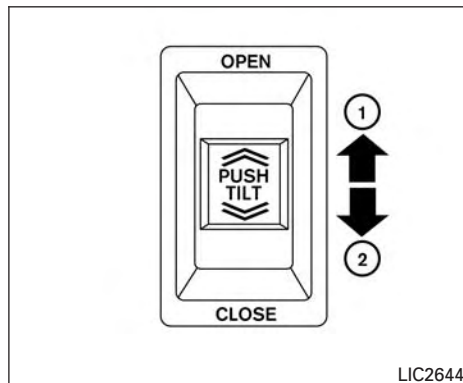

LIC2644

The moonroof will only operate when the ignition switch is placed in the ON position. The moonroof is operational for a period of time, even if the ignition switch is placed in the ACC (if so equipped) or OFF position. If the driver's door or the front passenger's door is opened during this period of time, the power to the moonroof is canceled.

### Sliding the moonroof

To fully open or close the moonroof, push the switch to the open ① or close ② position and release it; it need not be held. The roof will automatically open or close all the way. To stop the roof, push the switch once more while it is opening or closing.

## Tilting the moonroof

To tilt up, first close the moonroof, then push the switch to the tilt up position ① and release it; it need not be held. To tilt down the moonroof, push the switch to the tilt down position ②.

## Auto-reverse function (when closing or tilting down the moonroof)

The auto-reverse function can be activated when the moonroof is closed or tilted down by automatic operation when the ignition switch is placed in the ON position or for a period of time after the ignition switch is placed in the OFF position.

**Depending on the environment or driving conditions, the auto-reverse function may be activated if an impact or load similar to something being caught in the moonroof occurs.**

### WARNING

There are some small distances immediately before the closed position which cannot be detected. Make sure that all passengers have their hands, etc., inside the vehicle before closing the moonroof.

## When closing:

If the control unit detects something caught in the moonroof as it moves to the front, the moonroof will immediately open backward.

## When tilting down:

If the control unit detects something caught in the moonroof as it tilts down, the moonroof will immediately tilt up.

If the auto-reverse function malfunctions and repeats opening or tilting up the moonroof, keep pushing the tilt down switch within 5 seconds after it happens; the moonroof will fully close gradually. Make sure nothing is caught in the moonroof.

### WARNING

- In an accident you could be thrown from the vehicle through an open moonroof. Always use seat belts and child restraints.
- Do not allow anyone to stand up or extend any portion of their body out of the moonroof opening while the vehicle is in motion or while the moonroof is closing.

### CAUTION

- Remove water drops, snow, ice or sand from the moonroof before opening.
- Do not place heavy objects on the moonroof or surrounding area.

## Panoramic sunshade

The panoramic sunshade operates when the ignition switch is in the ON position. When opening or closing the sunshade the switch need not be held.

To open the sunshade:

- To fully open the sunshade, push the switch ① toward the open position.

To close the sunshade:

- To fully close the sunshade, push the switch ② toward the close position.

### WARNING

- To avoid personal injury, keep your hands, fingers and head away from the sunshade arm, the arm rail and sunshade inlet port.
- Do not allow children near the rear sunshade system. They could be injured.



- Do not place objects on or near the rear sunshade. This could cause improper operation or damage it.
- Do not pull or push the rear sunshade. This could cause improper operation or damage it.

### **CAUTION**

- Do not place objects (such as newspapers, handkerchiefs, etc.) on the sunshade inlet port. Doing so may entangle these objects in the sunshade when it is extending or retracting, causing improper operation or damage to the sunshade.
- Do not push the sunshade arm with your hands, etc., as this may deform it. Improper operation or damage to the sunshade may result.
- Do not put any object into the sunshade inlet port as this may result in improper operation or damage the sunshade.
- Do not hang any object on the arm rail as this may result in improper operation or damage the sunshade.

- Do not forcefully pull the sunshade. Doing so may elongate the sunshade. Improper operation or damage to the sunshade may result.

If the moonroof does not close

Have your NISSAN dealer check and repair the moonroof.

## INTERIOR LIGHT

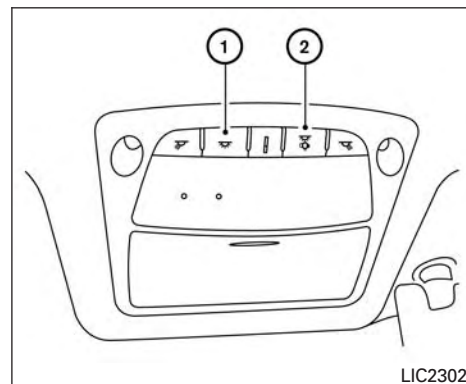

When the ON switch ① is pressed, the footwell lights (if so equipped), step lights (if so equipped), map lights and rear personal lights will automatically turn on and stay on for a period of time when:

- The doors are unlocked by the Intelligent Key, a key or the request switch (if so equipped) while all doors are closed and the ignition switch is in the OFF position.
- When individually pushed.

When the OFF switch ② is pushed, the interior lights do not illuminate even when pushed.

## NOTE:

The footwell lights and step lights illuminate when the driver and passenger doors are open regardless of the interior light switch position. These lights will turn off automatically after a period of time while doors are open to prevent the battery from becoming discharged.

### CAUTION

Do not use for extended periods of time with the engine stopped. This could result in a discharged battery.

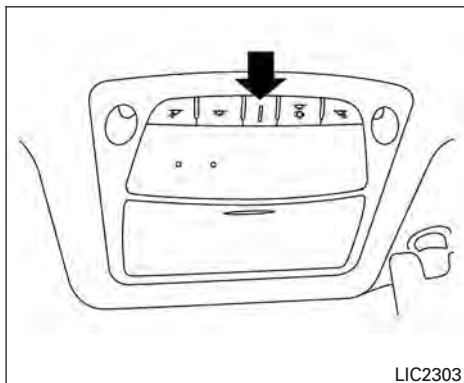

### CONSOLE LIGHT (if so equipped)

The console light will turn on whenever the parking lights or headlights are illuminated.

The console light brightness can be adjusted with the illumination brightness control.

## MAP LIGHTS

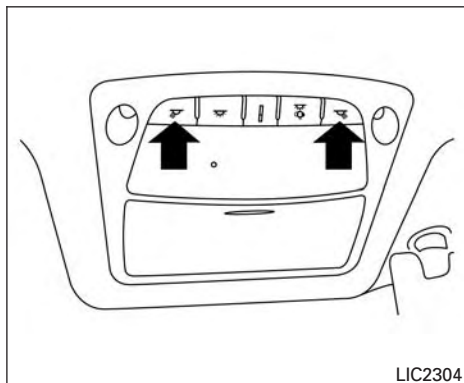

Push the button to turn the map lights on. To turn them off, press the button again.

### CAUTION

Do not use for extended periods of time with the engine stopped. This could result in a discharged battery.

## CARGO LIGHT

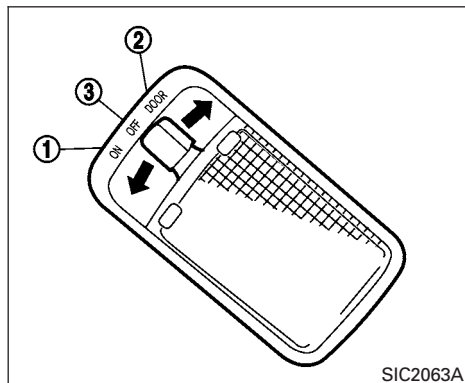

The cargo light on the overhead trim has a three-position switch. To operate, push the switch to the desired position.

- ① ON: The light is illuminated.
- ② DOOR: The light illuminates when the liftgate is opened. The light turns off when the liftgate is closed.
- ③ OFF: The light does not illuminate regardless of liftgate position or lock status.

### CAUTION

**Do not use for extended periods of time with the engine stopped. This could result in a discharged battery.**

## HOMELINK® UNIVERSAL TRANSCEIVER (if so equipped)

The HomeLink® Universal Transceiver provides a convenient way to consolidate the functions of up to three individual hand-held transmitters into one built-in device.

HomeLink® Universal Transceiver:

- Will operate most Radio Frequency (RF) devices such as garage doors, gates, home and office lighting, entry door locks and security systems.
- Is powered by your vehicle's battery. No separate batteries are required. If the vehicle's battery is discharged or is disconnected, HomeLink® will retain all programming.

**When the HomeLink® Universal Transceiver is programmed, retain the original transmitter for future programming procedures (Example: new vehicle purchases). Upon sale of the vehicle, the programmed HomeLink® Universal Transceiver buttons should be erased for security purposes. For additional information, refer to "Programming HomeLink®" later in this section.**

## **⚠ WARNING**

- **Do not use the HomeLink® Universal Transceiver with any garage door opener that lacks safety stop and reverse features as required by federal safety standards. (These standards became effective for opener models manufactured after April 1, 1982). A garage door opener which cannot detect an object in the path of a closing garage door and then automatically stop and reverse, does not meet current federal safety standards. Using a garage door opener without these features increases the risk of serious injury or death.**
- **During the programming procedure your garage door or security gate will open and close (if the transmitter is within range). Make sure that people or objects are clear of the garage door, gate, etc. that you are programming.**
- **Your vehicle's engine should be turned off while programming the HomeLink® Universal Transceiver.**

## PROGRAMMING HOMELINK®

If you have any questions or are having difficulty programming your HomeLink® buttons, refer to the HomeLink® web site at: [www.homelink.com](http://www.homelink.com) or call 1-800-355-3515.

### NOTE:

**Place the ignition switch in the ACC position (if so equipped) when programming HomeLink®. It is also recommended that a new battery be placed in the hand-held transmitter of the device being programmed to HomeLink® for quicker programming and accurate transmission of the radio-frequency.**

1. Position the end of your hand-held transmitter 1–3 in (2–8 cm) away from the HomeLink® surface, keeping the HomeLink® indicator light ① in view.

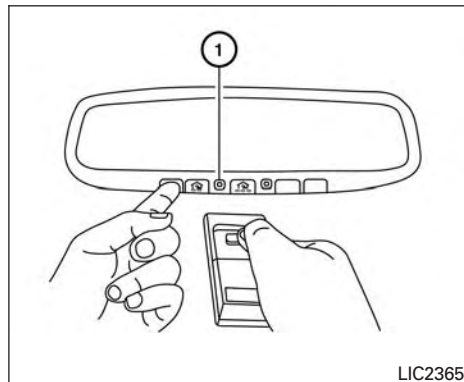

2. Using both hands, simultaneously press and hold the desired HomeLink® button and hand-held transmitter button. **DO NOT** release until the HomeLink® indicator light ① flashes slowly and then rapidly. When the indicator light flashes rapidly, both buttons may be released. (The rapid flashing indicates successful programming.)

### NOTE:

**Some devices may require you to replace Step 2 with the cycling procedure noted in “Programming HomeLink® for Canadian customers and gate openers” in this section.**

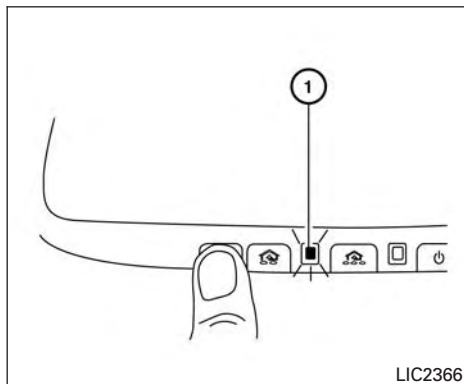

3. Press and hold the programmed HomeLink® button and observe the indicator light.

- If the indicator light ① is **solid/continuous, programming is complete** and your device should activate when the HomeLink® button is pressed and released.
- If the indicator light ① blinks **rapidly for two seconds and then turns to a solid/continuous light, continue with Steps 4-6** for a rolling code device. A second person may make the following steps easier. Use a ladder or other device.

Do not stand on your vehicle to perform the next steps.

4. At the receiver located on the garage door opener motor in the garage, locate the “learn” or “smart” button (the name and color of the button may vary by manufacturer but it is usually located near where the hanging antenna wire is attached to the unit). If there is difficulty locating the button, reference the garage door opener’s manual.
5. Press and release the “learn” or “smart” button.
6. Return to the vehicle and firmly press and hold the trained HomeLink® button for two seconds and release. Repeat the “press/hold/release” sequence up to 3 times to complete the training process. HomeLink® should now activate your rolling code equipped device.
7. If you have any questions or are having difficulty programming your HomeLink® buttons, refer to the HomeLink® web site at: [www.homelink.com](http://www.homelink.com) or call 1-800-355-3515.

## PROGRAMMING HOMELINK® FOR CANADIAN CUSTOMERS AND GATE OPENERS

Canadian radio-frequency laws require transmitter signals to “time-out” (or quit) after several seconds of transmission – which may not be long enough for HomeLink® to pick up the signal during training. Similar to this Canadian law, some U.S. gate operators are designed to “time-out” in the same manner.

If you live in Canada or you are having difficulties training a gate operator **or** garage door opener by using the “Training” procedures, **replace** “Programming HomeLink®” **Step 2** with the following:

### NOTE:

**When programming a garage door opener, etc., unplug the device during the “cycling” process to prevent possible damage to the garage door opener components.**

1. See “Programming HomeLink®” step 1 earlier in this section.
2. Using both hands, simultaneously press and hold the desired HomeLink® button and the hand-held transmitter button. During training, your hand-held transmitter may automatically stop transmitting. Continue to

press and hold the desired HomeLink® button while you press and re-press (“cycle”) your hand-held transmitter every two seconds until the frequency signal has been learned. The HomeLink® indicator light will flash slowly and then rapidly after several seconds upon successful training. DO NOT release until the HomeLink® indicator light flashes slowly and then rapidly. When the indicator light flashes rapidly, both buttons may be released. The rapid flashing indicates successful training.

Proceed with “Programming HomeLink®” step 3 to complete.

If the device was unplugged during the programming procedure, remember to plug it back in when programming is completed.

## OPERATING THE HOMELINK® UNIVERSAL TRANSCEIVER

The HomeLink® Universal Transceiver, after it is programmed, can be used to activate the programmed device. To operate, simply press and release the appropriate programmed HomeLink® Universal Transceiver button. The amber indicator light will illuminate while the signal is being transmitted.

For convenience, the hand-held transmitter of the device may also be used at any time.

## PROGRAMMING TROUBLE-DIAGNOSIS

If the HomeLink® does not quickly learn the hand-held transmitter information:

- replace the hand-held transmitter batteries with new batteries.
- position the hand-held transmitter with its battery area facing away from the HomeLink® surface.
- press and hold both the HomeLink® and hand-held transmitter buttons without interruption.
- position the hand-held transmitter 1 - 3 in (26 - 76 mm) away from the HomeLink® surface. Hold the transmitter in that position for up to 15 seconds. If HomeLink® is not programmed within that time, try holding the transmitter in another position – keeping the indicator light in view at all times.

If you have any questions or are having difficulty programming your HomeLink® buttons, refer to the HomeLink® web site at: [www.homelink.com](http://www.homelink.com) or call 1-800-355-3515.

## CLEARING THE PROGRAMMED INFORMATION

The following procedure clears the programmed information from both buttons. Individual buttons cannot be cleared. However, individual buttons can be reprogrammed. See “Reprogramming a single HomeLink® button” in this section.

To clear all programming:

1. Press and hold the two outer HomeLink® buttons until the indicator light begins to flash in approximately 10 seconds. Do not hold for longer than 20 seconds.
2. Release both buttons.

HomeLink® is now in the programming mode and can be programmed at any time beginning with “Programming HomeLink®” - Step 1.

## REPROGRAMMING A SINGLE HOMELINK® BUTTON

To reprogram a HomeLink® Universal Transceiver button, complete the following:

1. Press and hold the desired HomeLink® button. **DO NOT** release the button.
2. The indicator light will begin to flash after 20 seconds. Without releasing the HomeLink® button, proceed with “Programming HomeLink®” - Step 1.

For questions or comments, contact HomeLink® at: [www.homelink.com](http://www.homelink.com) or 1-800-355-3515 (except Mexico).

The HomeLink® Universal Transceiver button has now been reprogrammed. The new device can be activated by pushing the HomeLink® button that was just programmed. This procedure will not affect any other programmed HomeLink® buttons.

## IF YOUR VEHICLE IS STOLEN

If your vehicle is stolen, you should change the codes of any non-rolling code device that has been programmed into HomeLink®. Consult the Owner's Manual of each device or call the manufacturer or dealer of those devices for additional information.

**When your vehicle is recovered, you will need to reprogram the HomeLink® Universal Transceiver with your new transmitter information.**

### FCC Notice:

#### For USA:

**This device complies with Part 15 of the FCC Rules. Operation is subject to the following two conditions: (1) This device may not cause harmful interference, and (2) this device must accept any interference received, including interference that may cause undesired operation.**

### NOTE:

**Changes or modifications not expressly approved by the party responsible for compliance could void the user's authority to operate the equipment.**

#### For Canada:

**This device complies with Industry Canada license-exempt RSS standard(s). Operation is subject to the following two conditions: (1) this device may not cause interference, and (2) this device must accept any interference, including interference that may cause undesired operation of the device.**

# 3 Pre-driving checks and adjustments

Keys .....	3-2	Hood .....	3-22
Remote keyless entry (if so equipped) .....	3-2	Liftgate .....	3-23
NISSAN Intelligent Key® (if so equipped) .....	3-3	Operating the manual liftgate (if so equipped) .....	3-23
NISSAN Vehicle Immobilizer System keys .....	3-4	Operating the power liftgate (if so equipped) .....	3-23
Doors .....	3-5	Power liftgate main switch .....	3-26
Locking with key .....	3-5	Liftgate release .....	3-26
Opening and closing windows .....	3-5	Liftgate position setting .....	3-27
Locking with inside lock knob .....	3-6	Fuel-filler door .....	3-27
Locking with power door lock switch .....	3-6	Opener operation .....	3-27
Automatic door locks .....	3-6	Fuel-filler cap .....	3-27
Child safety rear door lock .....	3-7	Tilt/telescopic steering .....	3-29
Remote keyless entry system (if so equipped) .....	3-7	Manual operation .....	3-30
How to use remote keyless entry system .....	3-8	Sun visors .....	3-30
NISSAN Intelligent Key® (if so equipped) .....	3-11	Vanity mirrors .....	3-31
Operating range .....	3-12	Card holder (driver's side only) .....	3-31
Door locks/unlocks precaution .....	3-13	Mirrors .....	3-31
NISSAN Intelligent Key® Operation .....	3-14	Rearview mirror (if so equipped) .....	3-31
How to use the remote keyless entry function .....	3-17	Automatic anti-glare rearview mirror (if so equipped) .....	3-32
Warning signals .....	3-20	Outside mirrors .....	3-33
Troubleshooting guide .....	3-20		



## KEYS

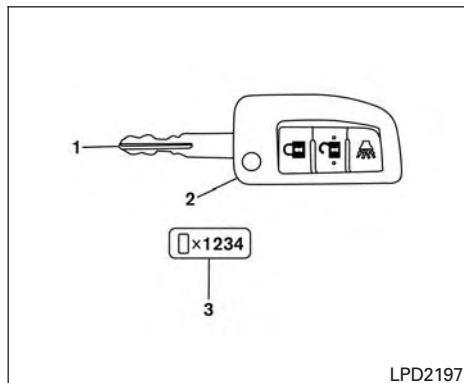

1. Jackknife type key
2. Integrated door lock keyfob with transponder chip
3. Key number plate

REMOTE KEYLESS ENTRY (if so equipped)

### CAUTION

**Do not leave the ignition key inside the vehicle when you leave the vehicle.**

A key number plate is supplied with your keys. Record the key number and keep it in a safe place (such as your wallet), not in the vehicle. If you lose your keys, see a NISSAN dealer for duplicates by using the key number. NISSAN does not record key numbers so it is very important to keep track of your key number plate.

A key number is only necessary when you have lost all keys and do not have one to duplicate from. If you still have a key, your NISSAN dealer can duplicate it.

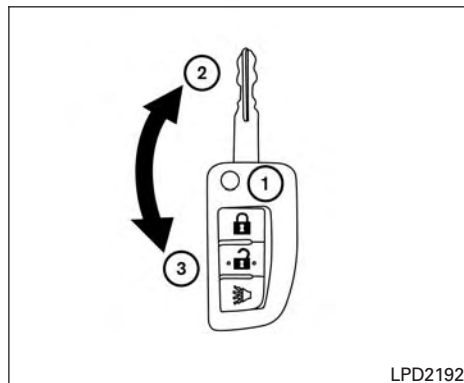

### Storing remote keyless entry

To lock or unlock the vehicle using the key press the release button ① to unfold the key from the fob.

When storing the key press the release button ① and push key ② to fold the key back into fob slot ③.

**Never leave keys in vehicle.**

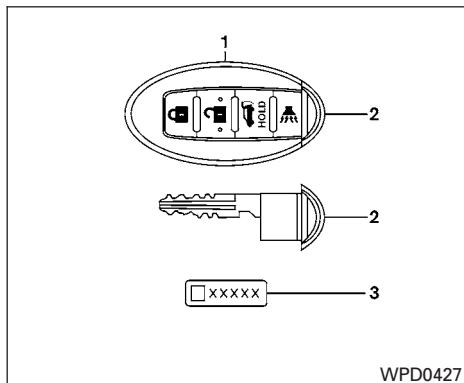

1. Two Intelligent Keys
2. Mechanical keys (inside Intelligent Keys)
3. Key number plate

NISSAN INTELLIGENT KEY® (if so equipped)

Your vehicle can only be driven with the Intelligent Keys which are registered to your vehicle's Intelligent Key components and NISSAN Vehicle Immobilizer System components.

### Never leave these keys in the vehicle.

As many as 4 Intelligent Keys can be registered and used with one vehicle. The new keys must be registered by a NISSAN dealer prior to use with the Intelligent Key and NISSAN Vehicle Immobilizer System of your vehicle. Since the registration process requires erasing all memory in the Intelligent Key components when registering new keys, be sure to take all Intelligent Keys that you have to the NISSAN dealer.

### ⚠ CAUTION

Listed below are conditions or occurrences which will damage the Intelligent Key:

- Do not allow the Intelligent Key, which contains electrical components, to come into contact with water or salt water. This could affect the system function.
- Do not drop the Intelligent Key.
- Do not strike the Intelligent Key sharply against another object.
- Do not change or modify the Intelligent Key.

- Wetting may damage the Intelligent Key. If the Intelligent Key gets wet, immediately wipe until it is completely dry.
- Do not place the Intelligent Key for an extended period in an area where temperatures exceed 140°F (60°C).
- Do not attach the Intelligent Key with a key holder that contains a magnet.
- Do not place the Intelligent Key near equipment that produces a magnetic field, such as a TV, audio equipment and personal computers.

If an Intelligent Key is lost or stolen, NISSAN recommends erasing the ID code of that Intelligent Key from the vehicle. This may prevent the unauthorized use of the Intelligent Key to operate the vehicle. For information regarding the erasing procedure, contact a NISSAN dealer.

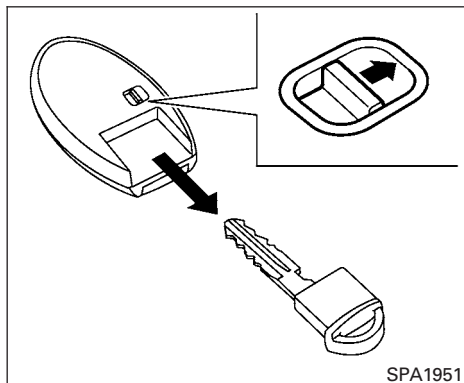

### Mechanical key

The Intelligent Key contains the mechanical key.

To remove the mechanical key, release the lock knob on the back of the Intelligent Key.

To install the mechanical key, firmly insert it into the Intelligent Key until the lock knob returns to the lock position.

Use the mechanical key to lock or unlock the driver's door.

### **CAUTION**

**Always carry the mechanical key installed in the Intelligent Key slot.**

See "Doors" in this section.

### NISSAN VEHICLE IMMOBILIZER SYSTEM KEYS

You can only drive your vehicle using the master keys which are registered to the NISSAN Vehicle Immobilizer System components in your vehicle. These keys have a transponder chip in the key head.

The master key can be used for all the locks.

**Never leave these keys in the vehicle.**

Additional or replacement keys:

If you still have a key, the key number is not necessary when you need extra NISSAN Vehicle Immobilizer System keys. Your dealer can duplicate your existing key. As many as 4 NISSAN Vehicle Immobilizer System keys can be used with one vehicle. You should bring all NISSAN Vehicle Immobilizer System keys that you have to your NISSAN dealer for registration. This is because the registration process will erase the memory of all key codes previously registered into the NISSAN Vehicle Immobilizer System. After the registration process, these components

will only recognize keys coded into the NISSAN Vehicle Immobilizer System during registration. Any key that is not given to your dealer at the time of registration will no longer be able to start your vehicle.

### **CAUTION**

**Do not allow the immobilizer system key, which contains an electrical transponder, to come into contact with water or salt water. This could affect system function.**

## DOORS

When the doors are locked using one of the following methods, the doors cannot be opened using the inside or outside door handles. The doors must be unlocked to open the doors.

### **⚠ WARNING**

- **Always have the doors locked while driving. Along with the use of seat belts, this provides greater safety in the event of an accident by helping to prevent persons from being thrown from the vehicle. This also helps keep children and others from unintentionally opening the doors, and will help keep out intruders.**
- **Before opening any door, always look for and avoid oncoming traffic.**
- **Do not leave children unattended inside the vehicle. They could unknowingly activate switches or controls. Unattended children could become involved in serious accidents.**

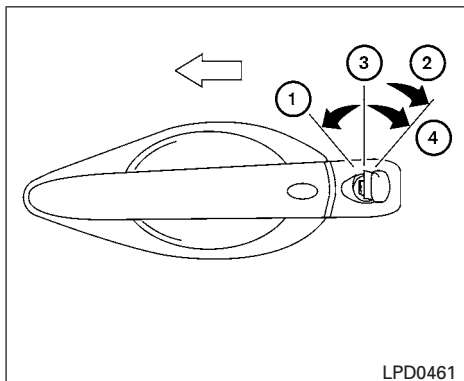

Driver's side

### LOCKING WITH KEY

The power door lock system allows you to lock or unlock all doors at the same time.

Turning the key toward the front ① of the vehicle locks all doors.

Turning the key one time toward the rear ② of the vehicle unlocks that door. From that position, returning the key to neutral ③ (where the key can only be removed and inserted) and turning it toward the rear again ④ within 5 seconds unlocks all doors.

## OPENING AND CLOSING WINDOWS

The driver's door key operation allows you to open and close windows equipped with automatic operation at the same time.

- To open the windows, turn the driver's door key toward the rear of the vehicle for **longer than 1 second** after the door is unlocked.
- To close the windows, turn the driver's door key toward the front of the vehicle for **longer than 1 second** after the door is locked.

Windows stop when the key cylinder is released.

### NOTE:

**When the window lock button is pressed the key will not operate the window open or close function.**

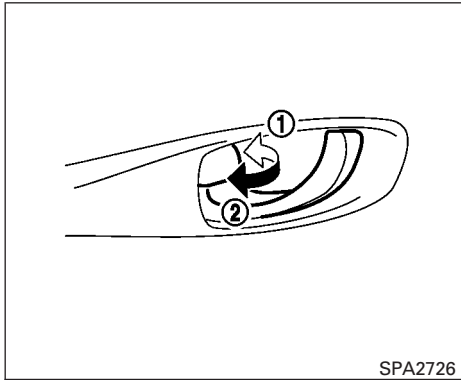

#### Inside lock

### LOCKING WITH INSIDE LOCK KNOB

To lock the door without the key, move the inside lock knob to the lock position ①, then close the door.

To unlock the door without the key, move the inside lock knob to the unlock position ②.

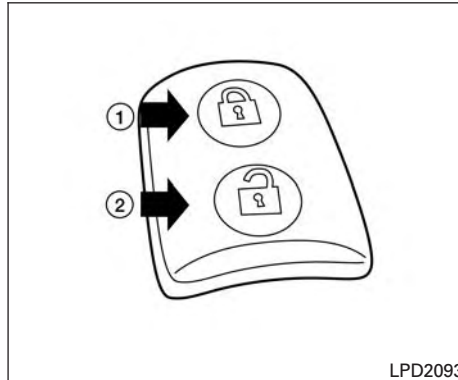

### LOCKING WITH POWER DOOR LOCK SWITCH

To lock all the doors without a key, push the door lock switch (driver's or front passenger's side) to the lock position ①. When locking the door this way, be certain not to leave the key inside the vehicle.

To unlock all the doors without a key, push the door lock switch (driver's or front passenger's side) to the unlock position ②.

### Lockout protection

When the power door lock switch is moved to the lock position and any door is open, all doors will lock and unlock automatically. With the Intelligent Key left in the vehicle and any door is open, all doors will unlock automatically and a chime will sound after the door is closed.

These functions help to prevent the Intelligent Key from being accidentally locked inside the vehicle.

### AUTOMATIC DOOR LOCKS

- All doors lock automatically when the vehicle speed reaches 15 MPH (24 km/h).
- All doors unlock automatically when the ignition is placed in the OFF position.

**The automatic unlock function can be deactivated or activated.** To deactivate or activate the automatic door unlock system, perform the following procedure:

1. Close all doors.
2. Place the ignition switch in the ON position.
3. Within 20 seconds of performing Step 2, push and hold the power door lock switch to the  position (UNLOCK) for more than 5 seconds.

- When activated, the hazard indicator will flash twice. When deactivated, the hazard indicator will flash once.
- The ignition switch must be placed in the OFF and ON position again between each setting change.

When the automatic door unlock system is deactivated, the doors do not unlock when the ignition switch is placed in the OFF position. To unlock the door manually, use the inside lock knob or the power door lock switch (driver's or front passenger's side).

**NOTE:**

**The automatic door unlock function can be changed using the Vehicle Settings in the vehicle information display. The "Selective Unlock" choices are:**

- ON
- OFF

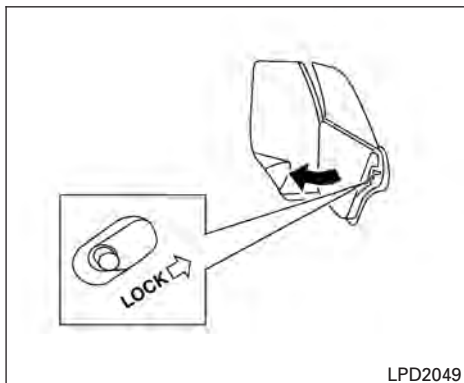

### CHILD SAFETY REAR DOOR LOCK

Child safety locks help prevent the rear doors from being opened accidentally, especially when small children are in the vehicle.

The child safety lock levers are located on the edge of the rear doors.

**When the lever is in the LOCK position, the door can be opened only from the outside.**

## REMOTE KEYLESS ENTRY SYSTEM (if so equipped)

### **⚠ WARNING**

- Radio waves could adversely affect electric medical equipment. Those who use a pacemaker should contact the electric medical equipment manufacturer for the possible influences before use.
- The remote keyless entry keyfob transmits radio waves when the buttons are pressed. The FAA advises radio waves may affect aircraft navigation and communication systems. Do not operate the remote keyless entry keyfob while on an airplane. Make sure the buttons are not operated unintentionally when the unit is stored for a flight.

It is possible to lock/unlock all doors, turn the interior lights on, and activate the panic alarm by using the keyfob from outside the vehicle.

**Be sure to remove the key from the vehicle before locking the doors.**

The keyfob can operate at a distance of approximately 33 ft (10 m) from the vehicle. The effective distance depends on the conditions around the vehicle.

As many as 4 keyfobs can be used with one vehicle. For information concerning the purchase and use of additional keyfobs, contact a NISSAN dealer.

The keyfob will not function when:

- the battery is discharged
- the distance between the vehicle and the keyfob is over 33 ft (10 m)

**The panic alarm will not activate when the key is in the ignition switch.**

#### **CAUTION**

Listed below are conditions or occurrences which will damage the keyfob:

- Do not allow the keyfob, which contains electrical components, to come into contact with water or salt water. This could affect the system function.
- Do not drop the keyfob.
- Do not strike the keyfob sharply against another object.
- Do not change or modify the keyfob.
- Wetting may damage the keyfob. If the keyfob gets wet, immediately wipe until it is completely dry.

- Do not place the keyfob for an extended period in an area where temperatures exceed 140°F (60°C).
- Do not attach the keyfob with a key holder that contains a magnet.
- Do not place the keyfob near equipment that produces a magnetic field, such as a TV, audio equipment and personal computers.

If a keyfob is lost or stolen, NISSAN recommends erasing the ID code of that keyfob. This will prevent the keyfob from unauthorized use to unlock the vehicle. For information regarding the erasing procedure, please contact a NISSAN dealer.



## HOW TO USE REMOTE KEYLESS ENTRY SYSTEM

### Locking doors



1. Remove the ignition key.
  2. Close all the doors.
  3. Push the LOCK  button on the keyfob.
- All the doors will lock.
  - The hazard indicator flashes twice and the horn beeps once .

## NOTE:

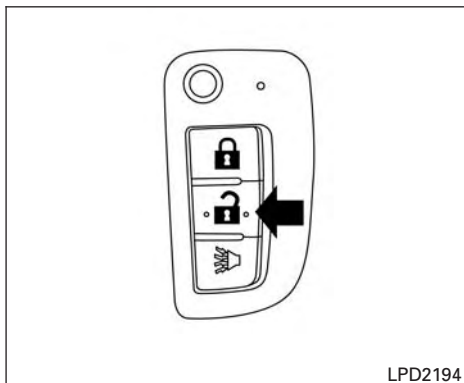
An auto-relock function will operate after a full or partial unlock, when no further user action occurs. The relock will operate approximately 1 minute after full or partial unlock. The auto-relock function is cancelled when any door is opened or the key is inserted into the ignition.



### Unlocking doors

1. Press the UNLOCK  button on the keyfob to unlock the driver's door.
2. The hazard warning lights flash once.
3. Press the UNLOCK  button again within 5 seconds to unlock all doors.



### Using the panic alarm

If you are near your vehicle and feel threatened, you may activate the panic alarm to call attention by pressing and holding the  button on the keyfob for **longer than 0.5 seconds**.

The panic alarm will stay on for a period of time.

The panic alarm stops when:

- it has run for a period of time, or
- any button is pressed on the keyfob.





## Using the interior light

Press the  button on the keyfob once to turn on the interior lights.

For additional information, refer to "Interior light" in the "Instruments and controls" section in this manual.



## Answer back horn feature



If desired, the answer back horn feature can be deactivated using the keyfob. When deactivated and the LOCK  button is pushed the hazard indicator flashes twice and when the UNLOCK  button is pushed, neither the hazard indicator nor the horn operates.

## NOTE:

**If you change the answer back horn and light flash feature with the keyfob, the vehicle information display screen will show the current mode after the ignition switch has been cycled from the OFF to the ON position. The vehicle information display screen can also be used to change the answer back horn mode. See "Answer back horn" in the "Instruments and controls" section.**

**To deactivate:** Press and hold the  and  buttons **for at least 2 seconds.**

The hazard warning lights will flash 3 times to confirm that the answer back horn feature has been deactivated.

**To activate:** Press and hold the  and  buttons **for at least 2 seconds once more.**

The hazard warning lights will flash once and the horn will sound once to confirm that the horn beep feature has been reactivated.

Deactivating the horn beep feature does not silence the horn if the alarm is triggered.

## NISSAN INTELLIGENT KEY® (if so equipped)

### WARNING

- Radio waves could adversely affect electric medical equipment. Those who use a pacemaker should contact the electric medical equipment manufacturer for the possible influences before use.
- The Intelligent Key transmits radio waves when the buttons are pressed. The FAA advises the radio waves may affect aircraft navigation and communication systems. Do not operate the Intelligent Key while on an airplane. Make sure the buttons are not operated unintentionally when the unit is stored for a flight.

The Intelligent Key system can operate all the door locks using the remote controller function or pushing the request switch on the vehicle without taking the key out from a pocket or purse. The operating environment and/or conditions may affect the Intelligent Key system operation.

Be sure to read the following before using the Intelligent Key system.

### CAUTION

- Be sure to carry the Intelligent Key with you when operating the vehicle.
- Never leave the Intelligent Key in the vehicle when you leave the vehicle.

The Intelligent Key is always communicating with the vehicle as it receives radio waves. The Intelligent Key system transmits weak radio waves. Environmental conditions may interfere with the operation of the Intelligent Key system under the following operating conditions:

- When operating near a location where strong radio waves are transmitted, such as a TV tower, power station and broadcasting station.
- When in possession of wireless equipment, such as a cellular telephone, transceiver, and CB radio.
- When the Intelligent Key is in contact with or covered by metallic materials.
- When any type of radio wave remote control is used nearby.
- When the Intelligent Key is placed near an electric appliance such as a personal computer.

- When the vehicle is parked near a parking meter.

In such cases, correct the operating conditions before using the Intelligent Key function or use the mechanical key.

Although the life of the battery varies depending on the operating conditions, the battery's life is approximately 2 years. If the battery is discharged, replace it with a new one.

When the Intelligent Key battery is low, an indicator illuminates in the Vehicle Information Display. See "Vehicle Information Display" in the "Instruments and controls" section.

Since the Intelligent Key is continuously receiving radio waves, if the key is left near equipment which transmits strong radio waves, such as signals from a TV and personal computer, the battery life may become shorter.

For information regarding replacement of a battery, see "Battery replacement" in the "Maintenance and do-it-yourself" section.

As many as 4 Intelligent Keys can be registered and used with one vehicle. For information about the purchase and use of additional Intelligent Keys, contact a NISSAN dealer.

## **⚠ CAUTION**

Listed below are conditions or occurrences which will damage the Intelligent Key:

- Do not allow the Intelligent Key, which contains electrical components, to come into contact with water or salt water. This could affect the system function.
- Do not drop the Intelligent Key.
- Do not strike the Intelligent Key sharply against another object.
- Do not change or modify the Intelligent Key.
- Wetting may damage the Intelligent Key. If the Intelligent Key gets wet, immediately wipe until it is completely dry.
- Do not place the Intelligent Key for an extended period in an area where temperatures exceed 140°F (60°C).
- Do not attach the Intelligent Key with a key holder that contains a magnet.
- Do not place the Intelligent Key near equipment that produces a magnetic field, such as a TV, audio equipment and personal computers.

If an Intelligent Key is lost or stolen, NISSAN recommends erasing the ID code of that Intelligent Key from the vehicle. This may prevent the unauthorized use of the Intelligent Key to operate the vehicle. For information regarding the erasing procedure, contact a NISSAN dealer.

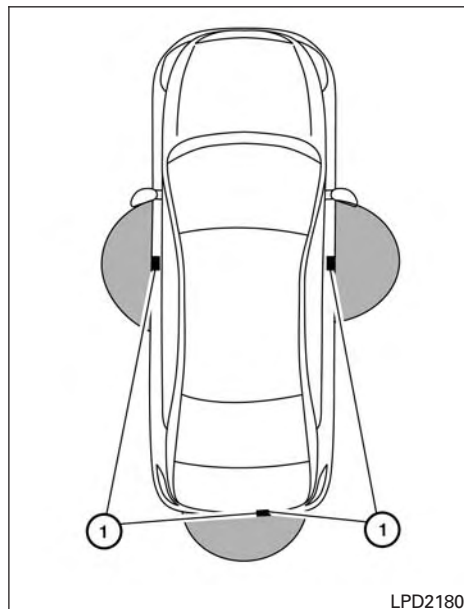

## **OPERATING RANGE**

The Intelligent Key functions can only be used when the Intelligent Key is within the specified operating range from the request switch ①.

When the Intelligent Key battery is discharged or strong radio waves are present near the operating location, the Intelligent Key operating range becomes narrower, and the Intelligent Key may not function properly.

The operating range is within 31.50 in (80 cm) from each request switch ①.

If the Intelligent Key is too close to the door glass, handle or rear bumper, the request switches may not function.

When the Intelligent Key is within the operating range, it is possible for anyone, even someone who does not carry the Intelligent Key, to push the request switch to lock/unlock the doors.

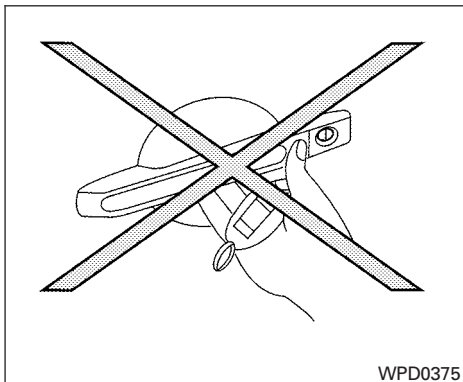

### DOOR LOCKS/UNLOCKS PRECAUTION

- Do not push the door handle request switch with the Intelligent Key held in your hand as illustrated. The close distance to the door handle will cause the Intelligent Key system to have difficulty recognizing that the Intelligent Key is outside the vehicle.
- After locking with the door handle request switch, verify the doors are securely locked by testing them.

- To prevent the Intelligent Key from being left inside the vehicle, make sure you carry the Intelligent Key with you and then lock the doors.
- Do not pull the door handle before pushing the door handle request switch. The door will be unlocked but will not open. Release the door handle once and pull it again to open the door.

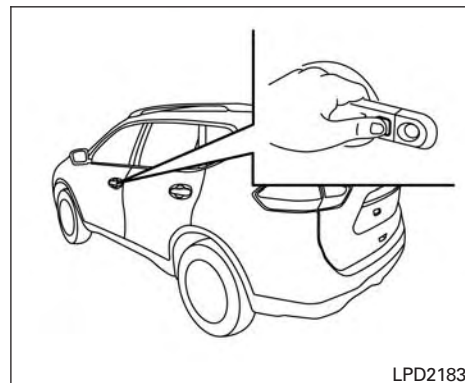
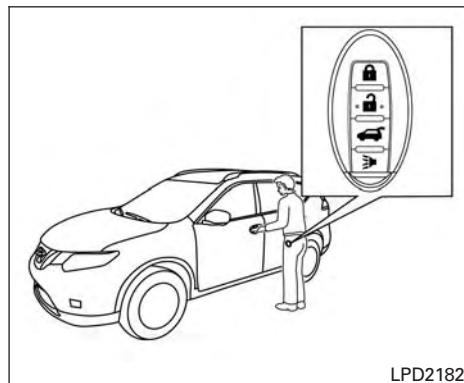
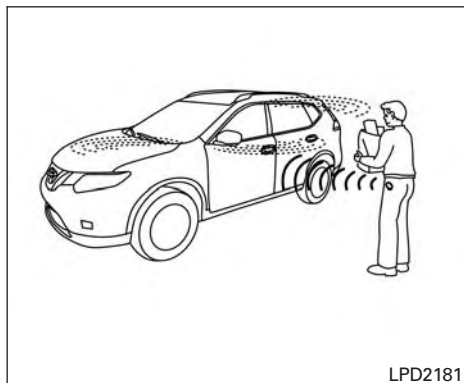

## NISSAN INTELLIGENT KEY® OPERATION

You can lock or unlock the doors without taking the Intelligent Key out of your pocket or bag.

When you carry the Intelligent Key with you, you can lock or unlock all doors by pushing the door handle request switch within the range of operation.

### Locking doors

1. Move the shift lever to the P (Park) position, place the ignition switch in the LOCK position and make sure you carry the Intelligent Key with you.
2. Close all doors.
3. Push any door handle request switch while carrying the Intelligent Key with you.
4. All doors and the rear liftgate will lock.
5. The hazard warning lights flash twice and the outside buzzer sounds once.

### NOTE:

- Request switches for all doors and liftgate can be deactivated when the I-Key Door Lock setting is switched to OFF in the Vehicle Settings of the vehicle information display. For additional information, see "Vehicle information display" in the "Instruments and controls" section of this manual.
- Doors lock with the door handle request switch while the ignition switch is not in the LOCK position.

- Doors do not lock by pushing the door handle request switch while any door is open. However, doors lock with the mechanical key even if any door is open.
- Doors do not lock with the door handle request switch with the Intelligent Key inside the vehicle and a beep sounds to warn you. However, when an Intelligent Key is inside the vehicle, doors can be locked with another Intelligent Key.

#### CAUTION

- After locking the doors using the request switch, make sure that the doors have been securely locked by operating the door handles or the rear liftgate opener switch.
- When locking the doors using the request switch, make sure to have the Intelligent Key in your possession before operating the request switch to prevent the Intelligent Key from being left in the vehicle.
- The request switch is operational only when the Intelligent Key has been detected by the Intelligent Key system.

#### Lockout protection

To prevent the Intelligent Key from being accidentally locked in the vehicle, lockout protection is equipped with the Intelligent Key system.

When the driver's side door is open, the doors are locked, and then the Intelligent Key is put inside the vehicle and all the doors are closed; the lock will automatically unlock and the door buzzer sounds.

#### NOTE:

The doors may not lock when the Intelligent Key is in the same hand that is operating the request switch to lock the door. Put the Intelligent Key in a purse, pocket or your other hand.

#### CAUTION

The lockout protection may not function under the following conditions:

- When the Intelligent Key is placed on top of the instrument panel.
- When the Intelligent Key is placed inside the glove box or a storage bin.
- When the Intelligent Key is placed inside the door pockets.
- When the Intelligent Key is placed inside or near metallic materials.

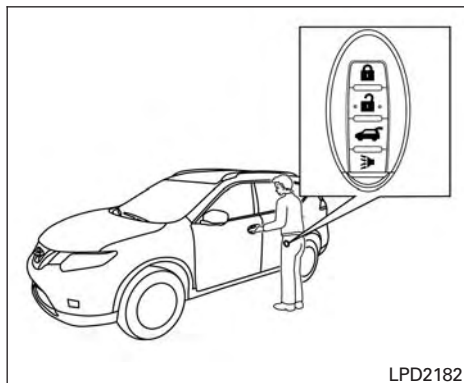

LPD2182

### Unlocking doors

1. Carry the Intelligent Key.
2. Push the door handle request switch.
3. The hazard warning lights flash once and the outside buzzer sounds once.
4. Push the door handle request switch again within 1 minute to unlock all doors.

For power liftgate opening:

1. Carry the Intelligent Key.
2. Press the power liftgate request switch.

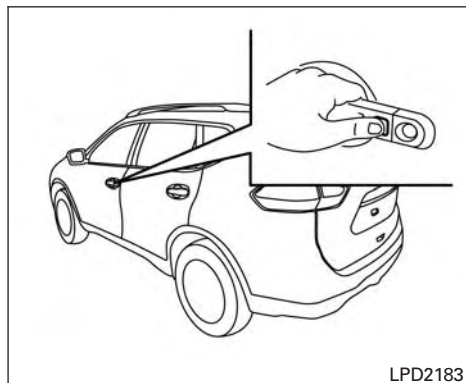

LPD2183

### NOTE:

**Request switches for all doors and liftgate can be deactivated when the I-Key Door Lock setting is switched to OFF in the Vehicle Settings of the vehicle information display. For additional information, see "Vehicle information display" in the "Instruments and controls" section of this manual.**

If a door handle is pulled while unlocking the doors, that door may not be unlocked. Returning the door handle to its original position will unlock the door. If the door does not unlock after return-

ing the door handle, push the door handle request switch to unlock the door.

All doors will be locked automatically unless one of the following operations is performed within 1 minute after pushing the request switch.

- Opening any door.
- Pushing the ignition switch.

The interior light timer illuminates for a period of time when a door is unlocked and the room light switch is in the DOOR position.

The interior light can be turned off without waiting by performing one of the following operations:

- Placing the ignition switch in the ON position.
- Locking the doors with the remote controller.
- Switching the room light switch to the OFF position.
- Switching the Auto Room Lamp to the OFF position in Vehicle Settings of the vehicle information display. See "Vehicle information display" in the "Instruments and controls" section.

## HOW TO USE THE REMOTE KEYLESS ENTRY FUNCTION

The remote keyless entry function can operate all door locks using the remote keyless function of the Intelligent Key. The remote keyless function can operate at a distance of 33 ft (10 m) away from the vehicle. The operating distance depends upon the conditions around the vehicle.

The remote keyless entry function will not function under the following conditions:

- When the Intelligent Key is not within the operational range.
- When the doors or the rear liftgate are open or not closed securely.
- When the Intelligent Key battery is discharged.

### CAUTION

**When locking the doors using the Intelligent Key, be sure not to leave the key in the vehicle.**

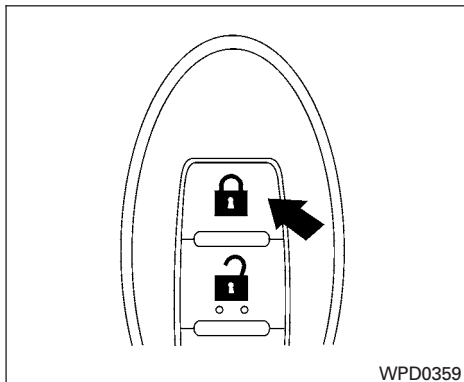

### Locking doors

1. Place the ignition switch in the LOCK position.
2. Close all doors.
3. Press the  button on the Intelligent Key.
4. The hazard warning lights flash twice and the horn beeps once.
5. All doors will be locked.

### CAUTION

**After locking the doors using the Intelligent Key, be sure that the doors have been securely locked by operating the door handles.**



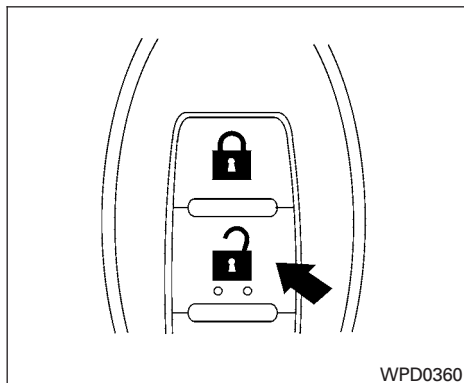

#### NOTE:

The unlocking operation can be changed in **Selective door unlock in the Vehicle Settings of the vehicle information display**. For additional information, see “**Vehicle information display**” in the “**Instruments and controls**” section of this manual.

All doors will be locked automatically unless one of the following operations is performed within 1 minute after pressing the  button:

- Opening any doors.
- Pushing the ignition switch.

The interior light illuminates for a period of time when a door is unlocked and the room light switch is in the DOOR position.

The light can be turned off without waiting by performing one of the following operations:

- Placing the ignition switch in the ON position.
- Locking the doors with the Intelligent Key.
- Switching the room light switch to the OFF position.

- Switching the Auto Room Lamp to the OFF position in Vehicle Settings of the vehicle information display. See “Vehicle information display” in the “Instruments and controls” section.

#### Opening windows



The Intelligent Key allows you to simultaneously open windows equipped with automatic operation.

- To open the windows, press the  button on the Intelligent Key for **longer than 3 seconds** after all doors are unlocked.

The door windows will open while pressing the  button on the Intelligent Key.

**The door windows cannot be closed by using the Intelligent Key.**

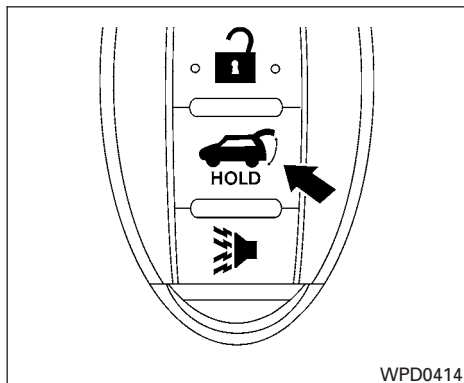

#### Unlocking doors

1. Press the  button on the Intelligent Key.
2. The hazard warning lights flash once.
3. Press the  button again within 5 seconds to unlock all doors.



### Releasing the rear liftgate

The rear liftgate can be opened and closed by performing the following:

- Press the  button for longer than 0.5 seconds to open the rear liftgate.
- Press the  button again for longer than 0.5 seconds to close the rear liftgate.

When the  button is pressed during the open or close process the liftgate will reverse.

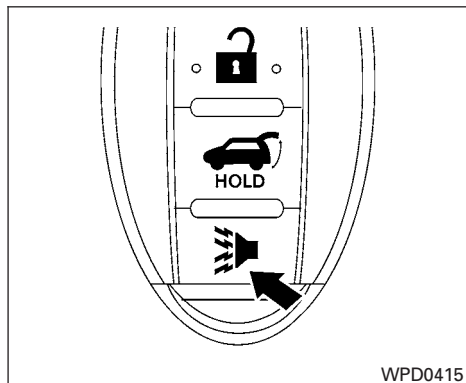

### Using the panic alarm

If you are near your vehicle and feel threatened, you may activate the panic alarm to call attention by pressing and holding the  button on the Intelligent Key for **longer than 0.5 seconds**.

The panic alarm and headlights will stay on for a period of time.

The panic alarm stops when:

- It has run for a period of time, or

- Any button is pressed on the Intelligent Key.
- The request switch on the driver or passenger door has been pushed and the Intelligent Key is in range of the door handle.



### Using the interior light

Press the  button on the keyfob once to turn on the interior lights.

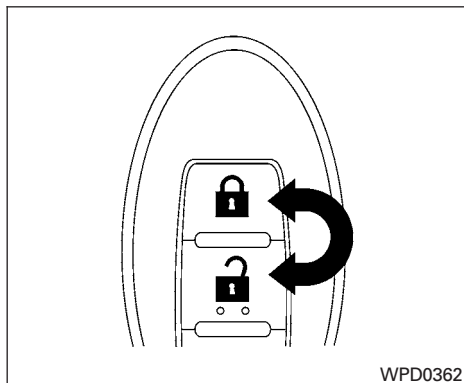
For additional information, refer to “Interior light” in the “Instruments and controls” section in this manual.



### Answer back horn feature



If desired, the answer back horn feature can be deactivated using the Intelligent Key. When deactivated and the LOCK  button is pushed the hazard indicator flashes twice and when the UNLOCK  button is pushed, neither the hazard indicator nor the horn operates.

#### NOTE:

**If you change the answer back horn and light flash feature with the Intelligent Key, the vehicle information display screen will show the current mode after the ignition switch has been cycled from the OFF to the ON position. The vehicle information display screen can also be used to change the answer back horn mode. See “Answer back horn” in the “Instruments and controls” section.**

**To deactivate:** Press and hold the  and  buttons **for at least 2 seconds.**

The hazard warning lights will flash 3 times to confirm that the answer back horn feature has been deactivated.

**To activate:** Press and hold the  and  buttons **for at least 2 seconds once more.**

The hazard warning lights will flash once and the horn will sound once to confirm that the horn beep feature has been reactivated.

Deactivating the horn beep feature does not silence the horn if the alarm is triggered.

### WARNING SIGNALS

To help prevent the vehicle from moving unexpectedly by erroneous operation of the Intelligent Key or to help prevent the vehicle from being stolen, a chime or buzzer sounds from inside and outside the vehicle and a warning is displayed in the instrument panel.

When a chime or beep sounds or a warning is displayed, be sure to check the vehicle and the Intelligent Key.

See the “Troubleshooting guide” in this section and “Vehicle information display” in the “Instruments and controls” section of this manual.

### TROUBLESHOOTING GUIDE

Verify the location of all Intelligent Keys that are programmed for the vehicle. If another Intelligent Key is in range or inside the vehicle, the vehicle system may respond differently than expected.

Symptom		Possible Cause	Remedy
When stopping the engine	The Shift to Park warning appears on the display and the inside warning chime sounds continuously.	The shift lever is not in the P (Park) position.	Move the shift lever to the P (Park) position.
When shifting the shift lever to the P (Park) position	The Push ignition to OFF warning appears in the display.	The ignition switch is in the ACC or ON position.	Place the ignition switch in the OFF position.
When opening the driver's door to get out of the vehicle	The Door Open warning appears on the display and the inside warning chime sounds continuously.	The ignition switch is in the ACC or ON position.	Place the ignition switch in the OFF position.
When closing the door after getting out of the vehicle	The No Key Detected warning appears on the display, the outside chime sounds 3 times and the inside warning chime sounds for approximately 3 seconds.	The ignition switch is in the ACC or ON position.	Place the ignition switch in the OFF position.
	The Shift to Park warning appears on the display and the outside chime sounds continuously.	The ignition switch is in the ACC position and the shift lever is not in the P (Park) position.	Move the shift lever to the P (Park) position and place the ignition switch in the OFF position.
When closing the door with the inside lock knob turned to LOCK	The outside chime sounds for approximately 3 seconds and all the doors unlock.	The Intelligent Key is inside the vehicle.	Carry the Intelligent Key with you.
When pushing the door handle request switch or the LOCK button on the Intelligent Key to lock the door	The outside chime sounds for approximately 2 seconds.	The Intelligent Key is inside the vehicle.	Carry the Intelligent Key with you.
When pushing the ignition switch to start the engine	The Intelligent Key battery indicator appears on the display.	The battery charge is low.	Replace the battery with a new one. (See "Battery replacement" in the "Maintenance and do-it-yourself" section.)
	The No Key Detected warning appears on the display, the outside chime sounds 3 times and the inside warning chime sounds for approximately 3 seconds.	The Intelligent Key is not in the vehicle.	Carry the Intelligent Key with you.
When pushing the ignition switch	The Intelligent Key system warning light in the meter illuminates in yellow.	It warns of a malfunction with the Intelligent Key system.	Contact a NISSAN dealer.

## HOOD

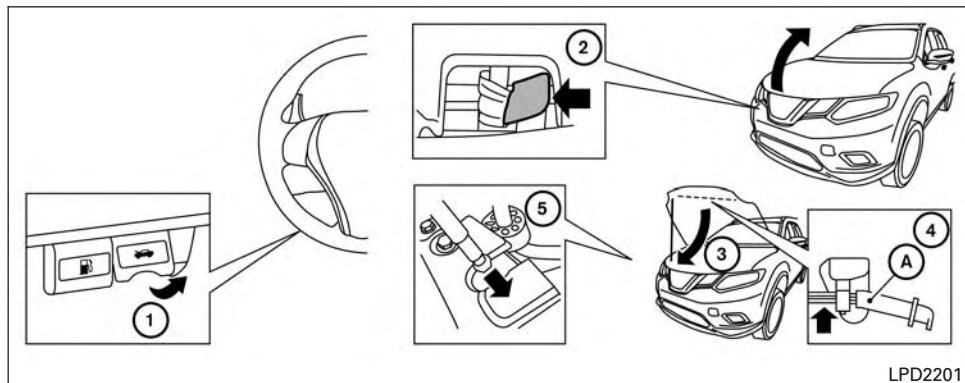

LPD2201

1. Pull the hood lock release handle ① located below the instrument panel until the hood springs up slightly.
2. Locate the lever ② in between the hood and grille and push the lever sideways with your fingertips.
3. Raise the hood ③.
4. Remove the support rod ④ and insert it into the slot ⑤.

**Hold the coated parts (A) when removing or resetting the support rod. Avoid direct contact with the metal parts, as they may be hot immediately after the engine has been stopped.**

When closing the hood, return the support rod to its original position, lower the hood to approximately 12 in (30 cm) above the latch and release it. This allows proper engagement of the hood latch.

### **⚠ WARNING**

- Make sure the hood is completely closed and latched before driving. Failure to do so could cause the hood to fly open and result in an accident.
- If you see steam or smoke coming from the engine compartment, to avoid injury do not open the hood.

## LIFTGATE

### WARNING

- Always be sure the liftgate has been closed securely to prevent it from opening while driving.
- Do not drive with the liftgate open. This could allow dangerous exhaust gases to be drawn into the vehicle. See “Exhaust gas (carbon monoxide)” in the “Starting and driving” section of this manual.
- Do not leave children unattended inside the vehicle. They could unknowingly activate switches or controls. Unattended children could become involved in serious accidents.
- Always be sure that hands and feet are clear of the door frame to avoid injury while closing the liftgate.

### CAUTION

Do not use accessory carriers that attach to the rear hatch. Doing so will cause damage to the vehicle.

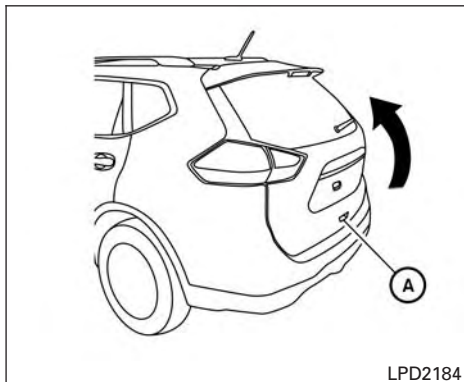

### OPERATING THE MANUAL LIFTGATE (if so equipped)

The power door lock system allows you to lock or unlock all doors including the liftgate simultaneously.

To open the liftgate, press the request switch  and pull up on the handle.

To close, lower and push the liftgate down securely.

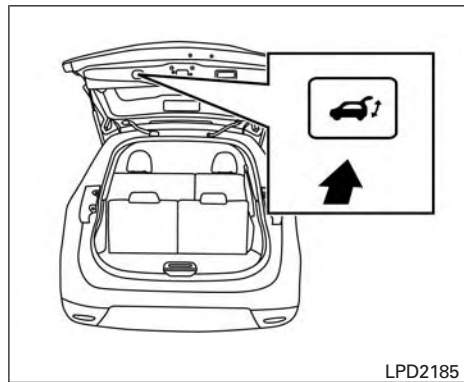

### Liftgate switch

### OPERATING THE POWER LIFTGATE (if so equipped)

### WARNING

- Make sure that all passengers have their hands, etc., inside the vehicle before closing the liftgate.
- Do not leave children unattended inside the vehicle. They could unknowingly activate switches or controls. Unattended children could become involved in serious accidents.

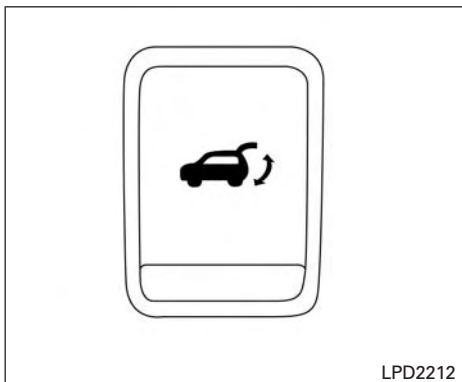

Instrument panel switch

### Power Open:

The power liftgate automatically moves from the fully closed position to the fully open position in approximately 5 – 8 seconds. The power open feature can be activated by the switch on the keyfob, the instrument panel switch and the liftgate request switch. The hazard lights flash and a chime sounds to indicate the power open sequence has been started.

### NOTE:

To open, close or reverse the power liftgate, the shift lever must be in P (Park). Also, the power liftgate will not operate if battery voltage is low.

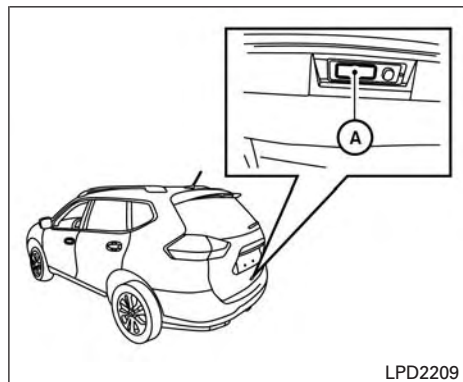

Liftgate opener switch

- The liftgate can be opened by the instrument panel switch, liftgate request switch and the keyfob even if the vehicle is locked. The liftgate will individually unlock and open. Once the liftgate is closed, the vehicle will remain in the unlock status.
- The keyfob button must be held for 0.5 second before the liftgate opens.
- The liftgate must be unlocked to open it with the liftgate opener switch (A).

A warning chime will sound if the shift lever is moved out of P (Park) during a power open operation.

### Power Close:

The power liftgate automatically moves from the fully open position to the secondary position. When the liftgate reaches the secondary position, the cinching motor engages and pulls the liftgate to its primary latch position. Power close takes approximately 7 – 10 seconds. The power close feature can be activated by the switch on the keyfob, the instrument panel and the liftgate opener switch (A). The hazard lights flash and a chime sounds to indicate the power close sequence has been started.

- If the liftgate opener switch (A) is activated while the cinching motor is engaged, the cinching motor will disengage and release the latch.
- The keyfob button must be held for 0.5 second before the liftgate closes.
- The switch on the liftgate can only be used to close the liftgate if the power liftgate main switch is in the ON position.

### Reverse:

The power liftgate will reverse direction immediately during power open or power close if the keyfob, instrument panel or liftgate switch is pushed or if the liftgate opener switch (A) is pushed. A chime will sound to announce the reversal.

### Auto Reverse:

If an obstacle is detected during power open or power close, a warning chime will sound and the liftgate will reverse direction and return to the full open or full close position. If a second obstacle is detected, the liftgate motion will stop and the liftgate will enter manual mode.

A pinch strip is mounted on each side of the liftgate. If an obstacle is detected by a pinch strip during power close, the liftgate will reverse direction and return to the full open position.

### NOTE:

**If the pinch strip is damaged or removed, the power close function will not operate.**

### WARNING

**There are some small distances immediately before the closed position which cannot be detected. Make sure that all passengers have their hands, etc., inside the vehicle before closing the liftgate.**

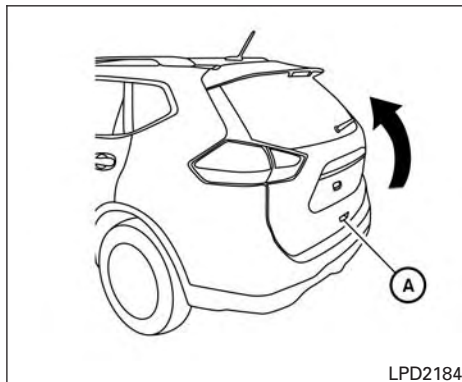

### Manual Mode:

If power operation is not available, the liftgate may be operated manually. Power operation may not be available if the power liftgate main switch is in the ON position, if multiple obstacles have been detected in a single power cycle, or if battery voltage is low.

If the power liftgate opener switch (A) is pushed during power open or close, the power operation will be canceled and the liftgate can be operated manually.

To open the liftgate manually, press the liftgate opener switch (A) and lift the liftgate.

To close, lower and push the liftgate down securely.



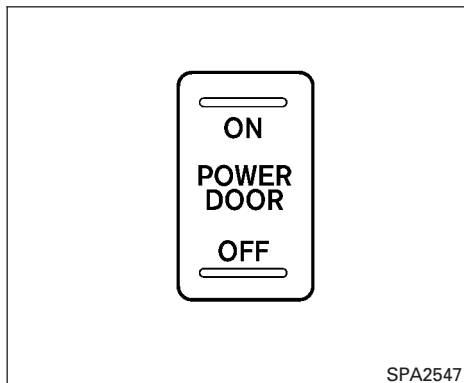

### POWER LIFTGATE MAIN SWITCH

The power liftgate operation can be turned on or off by the power liftgate main switch on the instrument panel.

When the power liftgate main switch is pushed to the OFF position, the power operation is not available by the power liftgate switch on the liftgate and liftgate opener switch.

Power operation is available when in the OFF position by the instrument panel switch and the keyfob button.

### LIFTGATE RELEASE

#### ⚠ WARNING

- Always be sure the liftgate has been closed securely to prevent it from opening while driving.
- Do not drive with the liftgate open. This could allow dangerous exhaust gases to be drawn into the vehicle. See “Exhaust gas (carbon monoxide)” in the “Starting and driving” section of this manual.

#### ⚠ CAUTION

- If the power liftgate does not stay open or if the liftgate unexpectedly closes at any time while a continuous warning chime sounds, do not operate the liftgate. There may be a pressure loss in one or both of the liftgate gas stays. Have the liftgate inspected by a NISSAN dealer.
- Do not activate the power liftgate if one or both of the liftgate gas stays are removed. Damage to the liftgate or power liftgate mechanisms may occur.

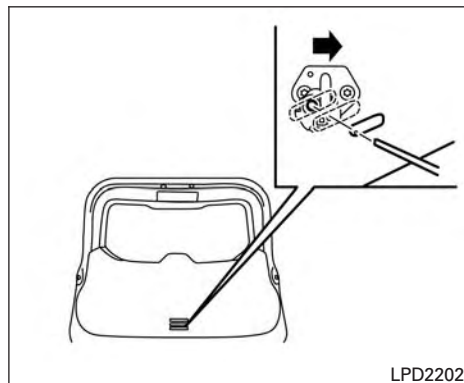

### Liftgate release (manual and power)

The liftgate release mechanism allows the liftgate to be opened in the event of a discharged battery.

To release the liftgate from the inside of the vehicle, perform the following operations:

1. Fold the rear seats down. See “Folding 3rd row bench (if so equipped)” in the “Safety — seats, seat belts and supplemental restraint system” section of this manual.
2. Insert a suitable tool in the access opening. Move the release lever to the right. The liftgate will be unlatched.
3. Push the liftgate up to open.

## FUEL-FILLER DOOR

### NOTE:

If you had to open the liftgate using this lever, have your vehicle checked by a NISSAN dealer as soon as possible.

### LIFTGATE POSITION SETTING

The liftgate can be set to open to a specific height by performing the following:

1. Open the liftgate using the request switch or the Intelligent Key.
2. Pull the liftgate down to the desired position and hold the liftgate (the liftgate will have some resistance when being manually adjusted).
3. While holding the liftgate in position, press and hold the liftgate switch  located on the liftgate for approximately 5 seconds or until 3 beeps are heard.

The liftgate will open to the selected position setting. To change the position of the liftgate, repeat steps 1-3 for setting the position of the liftgate.

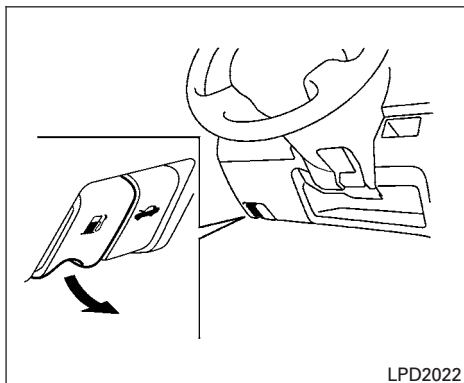

### OPENER OPERATION

The fuel-filler lid release is located below the instrument panel. To open the fuel-filler lid, pull the release. To lock, close the fuel-filler lid securely.

## FUEL-FILLER CAP

### WARNING

- Gasoline is extremely flammable and highly explosive under certain conditions. You could be burned or seriously injured if it is misused or mishandled. Always stop the engine and do not smoke or allow open flames or sparks near the vehicle when refueling.
- Do not attempt to top off the fuel tank after the fuel pump nozzle shuts off automatically. Continued refueling may cause fuel overflow, resulting in fuel spray and possibly a fire.
- Use only an original equipment type fuel-filler cap as a replacement. It has a built-in safety valve needed for proper operation of the fuel system and emission control system. An incorrect cap can result in a serious malfunction and possible injury. It could also cause the  Malfunction Indicator Light (MIL) to come on.
- Never pour fuel into the throttle body to attempt to start your vehicle.





- Do not fill a portable fuel container in the vehicle or trailer. Static electricity can cause an explosion of flammable liquid, vapor or gas in any vehicle or trailer. To reduce the risk of serious injury or death when filling portable fuel containers:

- Always place the container on the ground when filling.
- Do not use electronic devices when filling.
- Keep the pump nozzle in contact with the container while you are filling it.
- Use only approved portable fuel containers for flammable liquid.

#### CAUTION

- Do not use E-15 or E-85 fuel in your vehicle. For further information see the “Fuel Recommendation” in the “Technical and consumer information” section of this manual.

- The **LOOSE FUEL CAP** warning will appear if the fuel-filler cap is not properly tightened. It may take a few driving trips for the message to be displayed. Failure to tighten the fuel-filler cap properly after the **LOOSE FUEL CAP** warning appears may cause the  Malfunction Indicator Light (MIL) to illuminate.

- Failure to tighten the fuel-filler cap properly may cause the  Malfunction Indicator Light (MIL) to illuminate. If the  light illuminates because the fuel-filler cap is loose or missing, tighten or install the cap and continue to drive the vehicle. The  light should turn off after a few driving trips. If the  light does not turn off after a few driving trips, have the vehicle inspected by a NISSAN dealer.

- For additional information, see the “Malfunction Indicator Light (MIL)” in the “Instruments and Controls” section in this manual.

- If fuel is spilled on the vehicle body, flush it away with water to avoid paint damage.

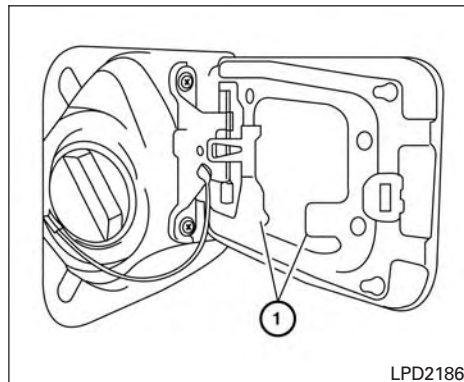



To remove the fuel-filler cap:

1. Turn the fuel-filler cap counterclockwise to remove.
2. Put the fuel-filler cap on the cap holder ① while refueling.

To install the fuel-filler cap:

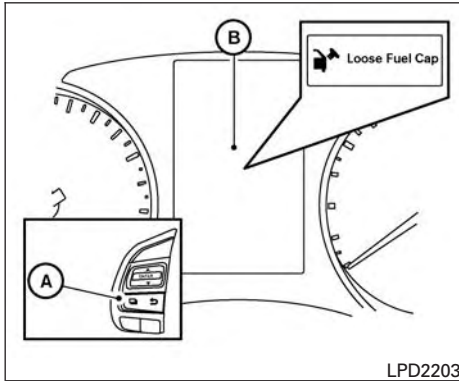
1. Insert the fuel-filler cap straight into the fuel-filler tube.
2. Turn the fuel-filler cap clockwise until a single click is heard.



- Press the  next button (A) on the steering wheel for about 1 second to turn off the LOOSE FUEL CAP warning (B) after tightening the fuel-filler cap.

### Loose Fuel Cap warning

The LOOSE FUEL CAP warning appears in the vehicle information display when the fuel-filler cap is not tightened correctly after the vehicle has been refueled. It may take a few driving trips for the message to be displayed. To turn off the warning, perform the following:

- Remove and install the fuel-filler cap as soon as possible. See "Fuel-filler cap" in this section.
- Tighten the fuel-filler cap until it clicks.

### WARNING

- Do not adjust the steering wheel while driving. You could lose control of your vehicle and cause an accident.
- Do not adjust the steering wheel any closer to you than is necessary for proper steering operation and comfort. The driver's air bag inflates with great force. If you are unrestrained, leaning forward, sitting sideways or out of position in any way, you are at greater risk of injury or death in a crash. You may also receive serious or fatal injuries from the air bag if you are up against it when it inflates. Always sit back against the seatback and as far away as practical from the steering wheel. Always use the seat belts.

## SUN VISORS

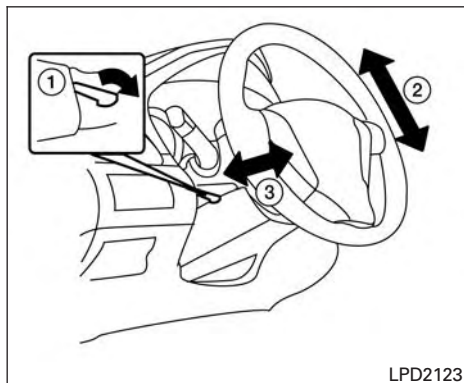

LPD2123

### MANUAL OPERATION

#### Tilt and telescopic operation

Pull the lock lever (1) down:

- Adjust the steering wheel forward or backward in direction (3) to the desired position.
- Adjust the steering wheel up or down in direction (2) to the desired position.

Push the lock lever (1) up firmly to lock the steering wheel in place.

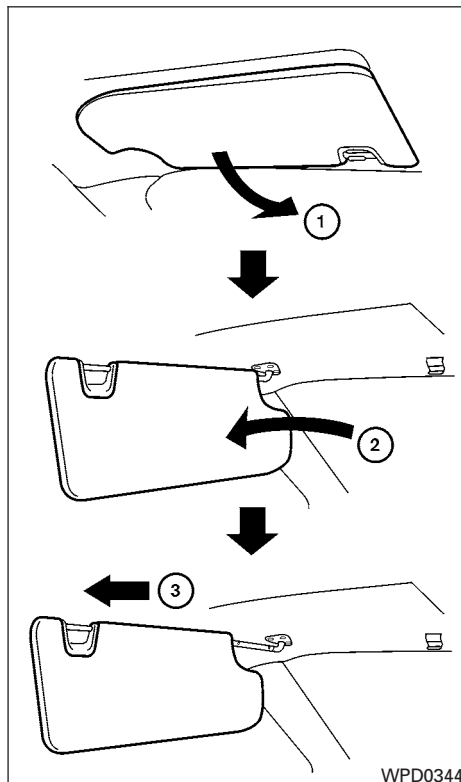

WPD0344

- ① To block glare from the front, swing down the main sun visor.
- ② To block glare from the side, remove the main sun visor from the center mount and swing the visor to the side.
- ③ To extend the sun visor, slide in or out as needed.

### CAUTION

- Do not store the sun visor before returning the extension to its original position.
- Do not pull the extension sun visor forcibly downward.

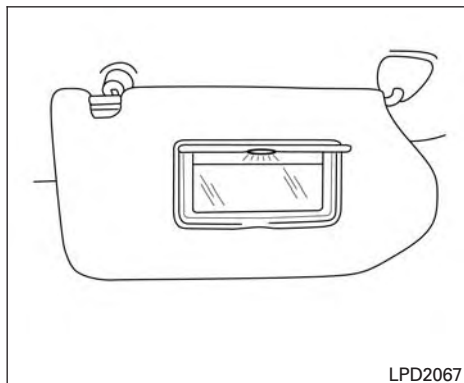

### VANITY MIRRORS

To access the vanity mirror, pull the sun visor down and flip open the mirror cover. Some vanity mirrors are illuminated and turn on when the mirror cover is open.

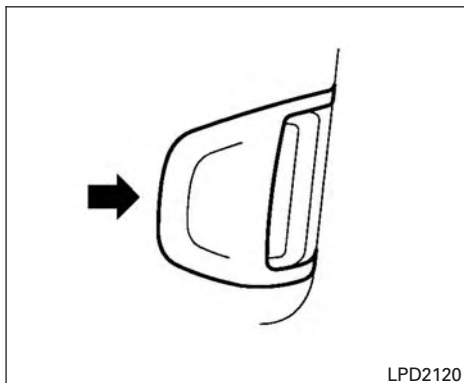

### CARD HOLDER (driver's side only)

To access the card holder, pull the sun visor down and slide card in the card holder. Do not view information while operating the vehicle.

## MIRRORS

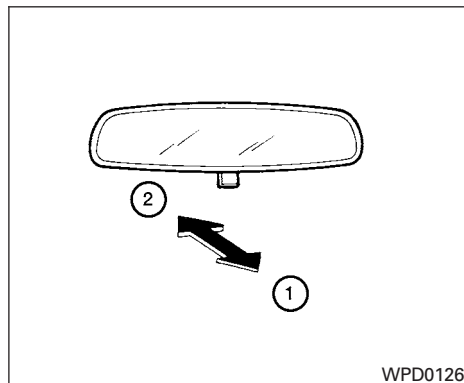

### REARVIEW MIRROR (if so equipped)

The night position ① reduces glare from the headlights of vehicles behind you at night.

Use the day position ② when driving in daylight hours.

#### **WARNING**

**Use the night position only when necessary, because it reduces rear view clarity.**

## AUTOMATIC ANTI-GLARE REARVIEW MIRROR (if so equipped)

The inside mirror is designed so that it automatically dims during night time conditions and according to the intensity of the headlights of the vehicle following you. The automatic anti-glare feature is activated when the ignition switch is in the ON position.

The indicator light will illuminate when the automatic anti-glare feature is operating.

### NOTE:

**Do not hang any objects over the sensors ① or apply glass cleaner to the sensors. Doing so will reduce the sensitivity of the sensors, resulting in improper operation.**

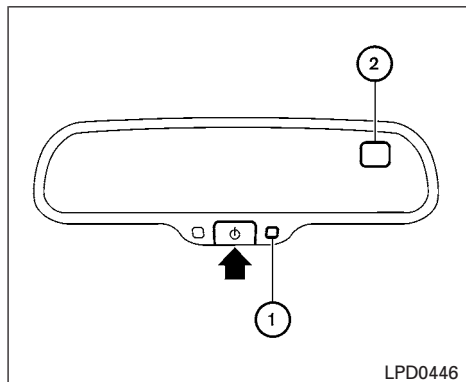



Type A

### Type A and Type B

The indicator light will illuminate when the automatic anti-glare feature is operating.

With the ignition switch in the ON position, press the  button as described:

- To turn off the anti-glare feature, press the  button. The indicator light will turn off.
- To turn on the anti-glare feature, press the  button again. The indicator light will turn on.

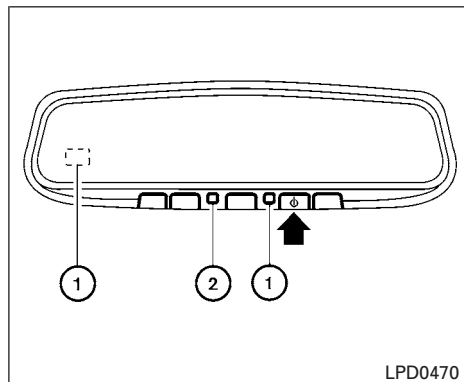

Type B

For information on HomeLink® Universal Transceiver (if so equipped) operation, see the “HomeLink® Universal Transceiver” in the “Instruments and controls” section of this manual.

For more information about the compass ② and compass features (if so equipped), refer to “Compass display” in the “Instruments and controls” section of this manual.

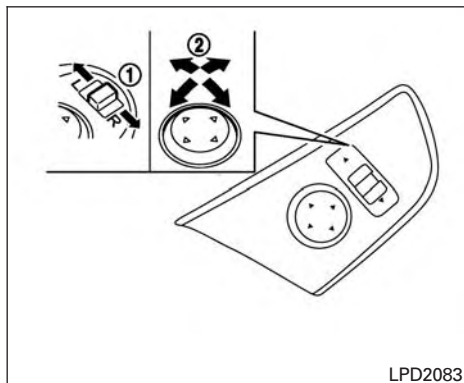

LPD2083

## OUTSIDE MIRRORS

The outside mirror remote control will operate only when the ignition switch is in the ACC or ON position.

Move the small switch ① to select the right or left mirror. Adjust each mirror to the desired position using the large switch ②.

### **⚠ WARNING**

- **Objects viewed in the outside mirror on the passenger side are closer than they appear. Be careful when moving to the right. Using only this mirror could cause an accident. Use the inside mirror or glance over your shoulder to properly judge distances to other objects.**
- **Do not adjust the mirrors while driving. You could lose control of your vehicle and cause an accident.**

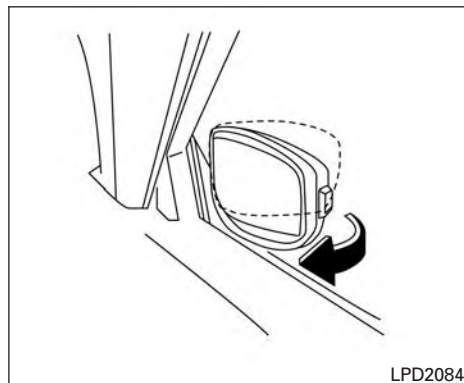

LPD2084

## Manual folding outside mirrors

Pull the outside mirror toward the door to fold it.

## Heated mirrors (if so equipped)

Some outside mirrors can be heated to defrost, defog, or de-ice for improved visibility. For additional information, see "Rear window and outside mirror defroster switch" in the "Instruments and controls" section of this manual.



# MEMO

# 4 Monitor, climate, audio, phone and voice recognition systems

Control panel buttons — color screen with Navigation System (if so equipped) . . . . .	4-4
How to use the touch screen . . . . .	4-5
How to use the BACK button . . . . .	4-7
How to use the APPS button . . . . .	4-7
☀/🔍 button . . . . .	4-9
How to use the POWER button/VOLUME control knob . . . . .	4-9
How to use the CAMERA button . . . . .	4-9
RearView Monitor (if so equipped) . . . . .	4-10
How to read the displayed lines . . . . .	4-11
Adjusting the screen . . . . .	4-11
Difference between predicted and actual distances . . . . .	4-12
Around View® Monitor (if so equipped) . . . . .	4-15
Available views . . . . .	4-16
Difference between predictive and actual distances . . . . .	4-19
How to switch the display . . . . .	4-21
How to adjust the Camera Settings . . . . .	4-22
Moving Object Detection (MOD) (if so equipped) . . . . .	4-22
Operating tips . . . . .	4-24
Vents . . . . .	4-25
Heater and Air Conditioner (manual) (if so equipped) . . . . .	4-26
Controls . . . . .	4-27
Heater operation . . . . .	4-28
Air conditioner operation . . . . .	4-29
Air flow charts . . . . .	4-30
Heater and Air Conditioner (automatic) (if so equipped) . . . . .	4-34
Automatic operation . . . . .	4-35
Manual operation . . . . .	4-36
Operating tips . . . . .	4-36
Servicing air conditioner . . . . .	4-37
Audio system . . . . .	4-37
Radio . . . . .	4-37
FM radio reception . . . . .	4-38
AM radio reception . . . . .	4-38
Satellite radio reception (if so equipped) . . . . .	4-38
Audio operation precautions . . . . .	4-39
FM/AM radio with compact disc (CD) player (Type A) (if so equipped) . . . . .	4-46
FM/AM radio with compact disc (CD) player (Type B) (if so equipped) . . . . .	4-50
FM/AM/SAT radio with compact disc (CD) player (Type A) (if so equipped) . . . . .	4-54

FM/AM/SAT radio with compact disc (CD) player (Type B) (if so equipped) . . . . .	4-60
USB interface (models without Navigation System) (if so equipped) . . . . .	4-64
USB interface (models with Navigation System) (if so equipped) . . . . .	4-66
iPod®* player operation without Navigation System (if so equipped) . . . . .	4-68
iPod®* player operation with Navigation System (if so equipped) . . . . .	4-70
Bluetooth® streaming audio without Navigation System (if so equipped) . . . . .	4-73
Bluetooth® streaming audio with Navigation System (if so equipped) . . . . .	4-74
CD care and cleaning . . . . .	4-75
Steering wheel switch for audio control . . . . .	4-76
Antenna . . . . .	4-77
NissanConnect™ App Smartphone Integration (if so equipped) . . . . .	4-78
Registering with NissanConnect™ App . . . . .	4-78
Connect Phone . . . . .	4-78
Application Download . . . . .	4-78
Car phone or CB radio . . . . .	4-79

Bluetooth® Hands-Free Phone System without Navigation System (if so equipped) . . . . .	4-79
Regulatory Information . . . . .	4-81
Using the system . . . . .	4-81
Control buttons . . . . .	4-83
Connecting procedure . . . . .	4-83
Voice commands . . . . .	4-85
Making a call . . . . .	4-86
Receiving a call . . . . .	4-87
During a call . . . . .	4-87
Ending a call . . . . .	4-87
Text messaging . . . . .	4-88
Bluetooth® settings . . . . .	4-89
Manual control . . . . .	4-90
Bluetooth® Hands-Free Phone System with Navigation System (if so equipped) . . . . .	4-91
Regulatory Information . . . . .	4-92
Voice commands . . . . .	4-93
Connecting Procedure . . . . .	4-93
Vehicle phonebook . . . . .	4-94
Making a call . . . . .	4-94
Receiving a call . . . . .	4-94

During a call . . . . .	4-94
Ending a call . . . . .	4-94
Text messaging. . . . .	4-95
Phone settings . . . . .	4-96
Bluetooth® settings . . . . .	4-97
<b>NISSAN Voice Recognition System</b> (if so equipped) . . . . .	4-98
Using the system . . . . .	4-98
System features . . . . .	4-99

<b>Bluetooth® Hands-Free Phone System</b>	
voice commands . . . . .	4-100
Navigation System voice commands . . . . .	4-101
Audio system voice commands. . . . .	4-101
Information voice commands. . . . .	4-101
My Apps Voice Commands . . . . .	4-101
Help voice commands . . . . .	4-102
Troubleshooting guide . . . . .	4-102



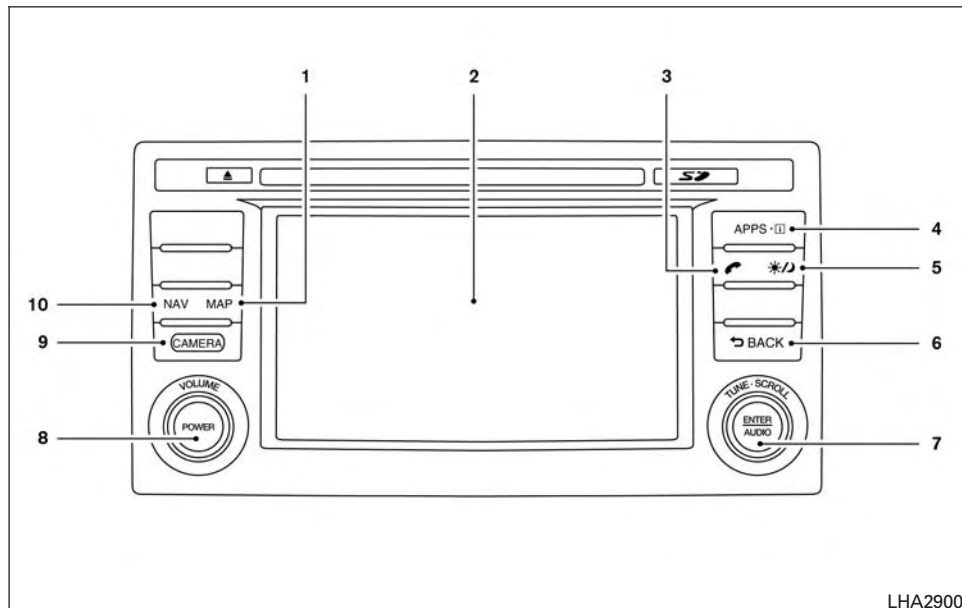

## CONTROL PANEL BUTTONS — COLOR SCREEN WITH NAVIGATION SYSTEM (if so equipped)

### WARNING

- Positioning of the heating or air conditioning controls and display controls should not be done while driving in order that full attention may be given to the driving operation.
- Do not disassemble or modify this system. If you do, it may result in accidents, fire, or electrical shock.
- Do not use this system if you notice any abnormality, such as a frozen screen or lack of sound. Continued use of the system may result in accident, fire or electric shock.
- In case you notice any foreign object in the system hardware, spill liquid on it, or notice smoke or smell coming from it, stop using the system immediately and contact your nearest NISSAN dealer. Ignoring such conditions may lead to accidents, fire or electrical shock.



LHA2900

1. MAP button\*
2. Display screen
3.  button\*\*
4. APPS  button
5.  (brightness control) button
6.  BACK button
7. ENTER / AUDIO button / TUNE / SCROLL knob
8. POWER button / VOLUME control knob

9. CAMERA button

10. NAV button\*

\* For information regarding the Navigation system control buttons, refer to the separate Navigation System Owner's Manual.

\*\* For information regarding the Bluetooth® Hands-Free Phone System control button, see "Bluetooth® Hands-Free Phone System with Navigation System" in this section.

When you use this system, make sure the engine is running.

**If you use the system with the engine not running (ignition ON or ACC) for a long time, it will discharge the battery, and the engine will not start.**

Reference symbols:

"Example" — Words marked in quotes refer to a key shown only on the display. These keys can be selected by touching the screen.

## HOW TO USE THE TOUCH SCREEN

### CAUTION

- **The glass display screen may break if it is hit with a hard or sharp object. If the glass screen breaks, do not touch it. Doing so could result in an injury.**
- **To clean the display, never use a rough cloth, alcohol, benzene, thinner or any kind of solvent or paper towel with a chemical cleaning agent. They will scratch or deteriorate the panel.**
- **Do not splash any liquid such as water or car fragrance on the display. Contact with liquid will cause the system to malfunction.**

To help ensure safe driving, some functions cannot be operated while driving.

The on-screen functions that are not available while driving will be "grayed out" or muted.

Park the vehicle in a safe location and then operate the navigation system.

### WARNING

- **ALWAYS give your full attention to driving.**
- **Avoid using vehicle features that could distract you. If distracted, you could lose control of your vehicle and cause an accident.**

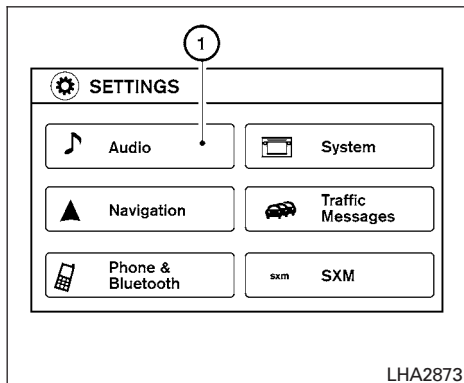

## Touch screen operation

Menu Item		Result
Selecting the item		Touch an item to select . To select the "Audio" key, touch the "Audio" key ① on the screen. Touch the "BACK" key to return to the previous screen.
Adjusting the item		Touch the "+" key or the "-" key to adjust the settings of an item. Touch the up arrow to scroll up the page one item at a time, or touch the double up arrow to scroll up an entire page. Touch the down arrow to scroll down the page one item at a time, or touch the double down arrow to scroll down an entire page.
Inputting characters		Touch the letter or number key. There are some options available when inputting characters.
	123/ABC	Changes the available character set to numbers.
	Space	Inserts a space.
	Delete	Deletes the last inputted character with one touch. Touch and hold the "Delete" key to delete all of the characters.
	OK	Completes the character input.

## Touch screen maintenance

If you clean the display screen, use a dry, soft cloth. If additional cleaning is necessary, use a small amount of neutral detergent with a soft cloth. Never spray the screen with water or detergent. Dampen the cloth first and then wipe the screen.

## HOW TO USE THE BACK BUTTON

Press the  BACK button to return to the previous screen.

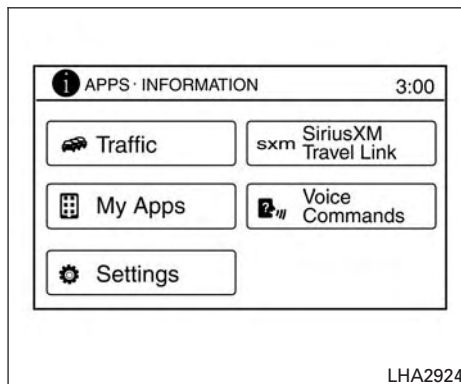

## HOW TO USE THE APPS BUTTON

For more information about the “SiriusXM Travel Link”, and “Traffic” features, see the separate Navigation System Owner’s Manual.

For more information about the “My Apps” key, see “NissanConnect™ App Smartphone Integration” in this section.

For more information about the “Voice Commands” key, see “NISSAN Voice Recognition System” in this section.

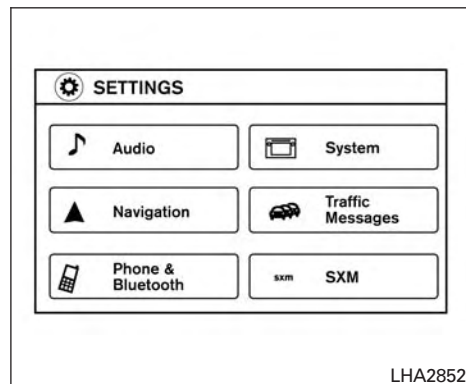



To select and/or adjust several functions, features and modes that are available for your vehicle:

1. Press the [ APPS  ] button.
2. Touch the “Settings” key.
3. Touch the desired item.

Menu item		Result
Audio		See “Audio system” in this section for more information.
Navigation		See the separate Navigation System Owner’s Manual for more information.
Phone & Bluetooth		See “Bluetooth Hands-Free Phone System with Navigation System” in this section.
System		Touch this key to select and/or adjust various functions of this system. A screen with additional options will appear.
	Display	Touch this key to adjust the appearance of the display.
	Brightness	Adjusts the brightness of the display.
	Display Mode	Adjusts to fit the level of lighting in the vehicle. Touch key to cycle through options. “Day” and “Night” modes are suited for the respective times of day while “Auto” controls the display automatically.
	Scroll Direction	Adjusts the direction of the menu scroll. Choose to either move up or down.
	Clock	Touch this key to adjust the time.
	Time Format	The clock can be set to 12 hours or 24 hours.
	Date Format	Select from five possible formats of displaying the day, month, and year.
	Clock Mode	Adjust the mode for the clock. “Auto” uses the system’s GPS to automatically maintain the time. “Manual” allows you to set the clock using the “Set Clock Manually” key.
	Set Clock Manually	Adjust the clock manually, Touch the “+” or “-” keys to adjust the hours, minutes, day, month and year up or down. “Clock Mode” must be set to manual for this option to be available.
	Daylight Savings Time	Adjusts the daylight savings time on or off.
	Time Zone	Choose the applicable time zone from the list.
	Language	Touch this key to change the language on the display.
	Camera	Touch this key to change the camera settings.

#### 4-8 Monitor, climate, audio, phone and voice recognition systems

Menu item	Result
Display Mode	Touch this key to select the touch-screen display mode (day, night, or automatic).
Brightness	Adjust touch-screen brightness.
Contrast	Adjust touch-screen contrast.
Color	Adjust touch-screen color.
Temperature Unit	Touch this key to change the temperature unit being displayed (Fahrenheit or Celsius).
Touchscreen click	Toggles the touch-screen click feature on or off. When activated a click sound will be heard every time a key on the screen is touched.
System Beeps	Toggle the system beep tones feature on or off. When activated, a beep sound will be heard when a pop-up message appears on the screen or a button on the unit (such as the ☀/🌙 button) is pressed and held for 2 seconds.
Return to Factory Settings/Clear Memory	Touch this key to return all settings to default and to clear the memory.
Software Licenses	Touch this key to display software licensing information.
Traffic messages	Touch this key to display traffic settings. See the separate Navigation System Owner's Manual for more information.
SXM	Touch this key to start SiriusXM® radio. For SXM setup, refer to "Audio system" in this section.

## ☀/🌙 BUTTON

To change the display brightness, press the ☀/🌙 button. Pressing the button again will change the display to the day or the night display.

If no operation is performed within 5 seconds, the display will return to the previous display.

Press and hold the ☀/🌙 button for more than two seconds to turn the display off. Press the button again to turn the display on.

## HOW TO USE THE POWER BUTTON/VOLUME CONTROL KNOB

Press the POWER button to turn audio function on and off. Turn the VOLUME control knob to adjust audio volume.

## HOW TO USE THE CAMERA BUTTON

For more information regarding the CAMERA button, see "REARVIEW MONITOR" in this section.

## REARVIEW MONITOR (if so equipped)

When the shift lever is shifted into the R (Reverse) position, the monitor display shows the view to the rear of the vehicle.

### WARNING

- Failure to follow the warnings and instructions for proper use of the RearView Monitor could result in serious injury or death.
- The RearView Monitor is a convenience but it is not a substitute for proper backing. Always turn and look out the windows, and check mirrors to be sure that it is safe to move before operating the vehicle. Always back up slowly.
- The system is designed as an aid to the driver in showing large stationary objects directly behind the vehicle, to help avoid damaging the vehicle.
- The system cannot completely eliminate blind spots and may not show every object.

- Underneath the bumper and the corner areas of the bumper cannot be viewed on the RearView Monitor because of its monitoring range limitation. The system will not show small objects below the bumper, and may not show objects close to the bumper or on the ground.
- Objects viewed in the RearView Monitor differ from actual distance because a wide-angle lens is used.
- Objects in a RearView Monitor will appear visually opposite than when viewed in the rear view and outside mirrors.
- Make sure that the liftgate is securely close when backing up.
- Do not put anything on the rearview camera. The rearview camera is installed on top of the liftgate.
- When washing the vehicle with high pressure water, be sure not to spray it around the camera. Otherwise, water may enter the camera unit causing water condensation on the lens, a malfunction, fire or an electric shock.

- Do not strike the camera. It is a precision instrument. Otherwise, it may malfunction or cause damage resulting in a fire or an electric shock.

### CAUTION

There is a plastic cover over the camera. Do not scratch the cover when cleaning dirt or snow from the cover.

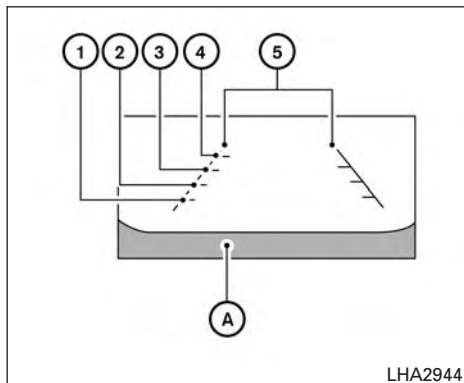

## HOW TO READ THE DISPLAYED LINES

Guiding lines which indicate the vehicle width and distances to objects with reference to the vehicle body line (A) are displayed on the monitor.

### Distance guide lines:

Indicate distances from the vehicle body.

- Red line ①: approx. 0.5 m (1.5 ft)
- Yellow line ②: approx. 1 m (3 ft)
- Green line ③: approx. 2 m (7 ft)
- Green line ④: approx. 3 m (10 ft)
- Vehicle width guide lines ⑤:  
Indicate the vehicle width when backing up.

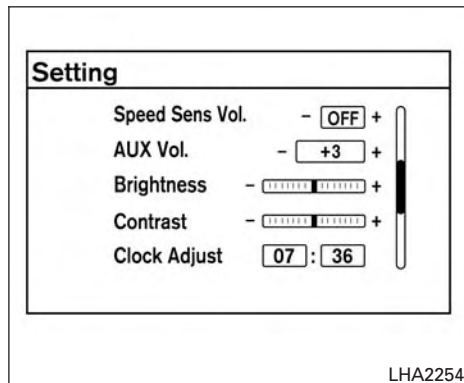

## ADJUSTING THE SCREEN

The procedure for adjusting the quality of the screen differs depending on the type of screen present on the vehicle.

For vehicles without Navigation System:

1. Press the ENTER/SETTING button.
2. Turn the TUNE/SCROLL or TUNE/FOLDER knob to highlight the "Brightness" or "Contrast" key.
3. Press the ENTER/SETTING button.

- Adjust the level using the TUNE/SCROLL or TUNE/FOLDER knob and then press the ENTER/SETTING button to apply the adjustment.
- Do not adjust the Brightness or Contrast of the RearView Monitor while the vehicle is moving.

### DIFFERENCE BETWEEN PREDICTED AND ACTUAL DISTANCES

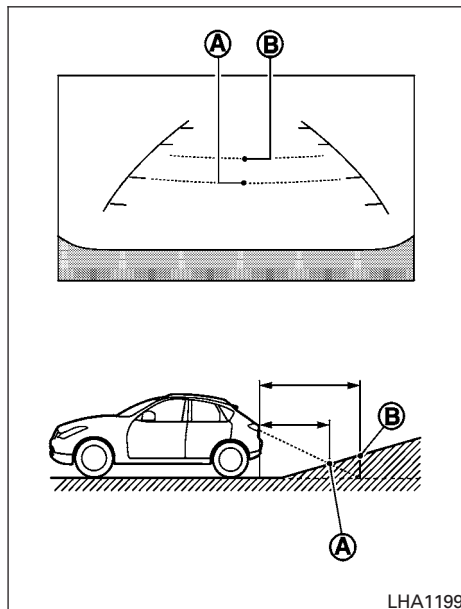

### Backing up on a steep uphill

When backing up the vehicle up a hill, the distance guide lines and the vehicle width guide lines are shown closer than the actual distance. For example, the display shows 3 ft (1.0 m) to the place **(A)**, but the actual 3 ft (1.0 m) distance on

the hill is the place **(B)**. Note that any object on the hill is further than it appears on the monitor.

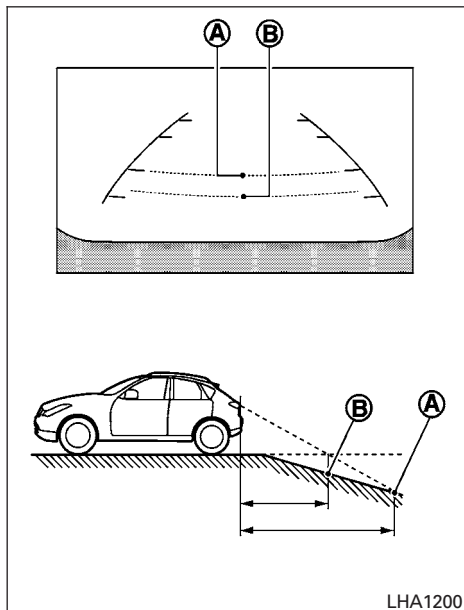

the hill is the place **B**. Note that any object on the hill is closer than it appears on the monitor.

### Backing up on a steep downhill

When backing up the vehicle down a hill, the distance guide lines and the vehicle width guide lines are shown farther than the actual distance. For example, the display shows 3 ft (1.0 m) to the place **A**, but the actual 3 ft (1.0 m) distance on

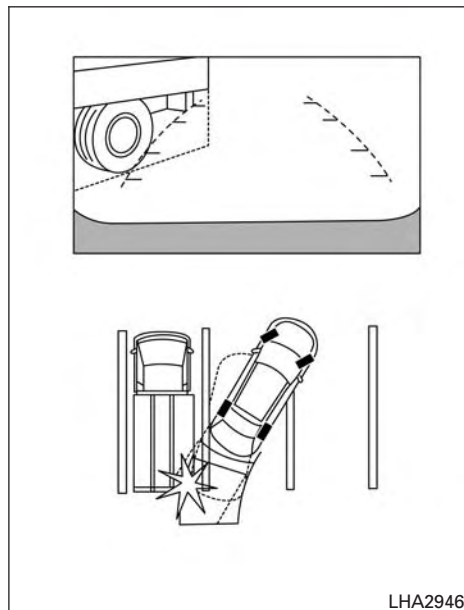

### Backing up near a projecting object

The vehicle may seem to nearly clear the object in the display. However, the vehicle may hit the object if it projects over the actual backing up course.

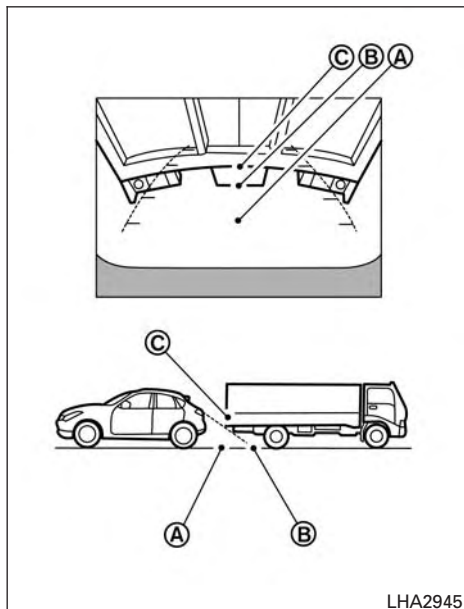

the position **(A)** if the object projects over the actual backing up course.

#### OPERATING TIPS

- When the shift lever is shifted to the R (Reverse) position, the monitor screen automatically changes to the RearView Monitor mode. However, the radio can be heard.
- When the view is switched, the display images on the screen may be displayed with some delay.
- When the temperature is extremely high or low, the screen may not clearly display objects. This is not a malfunction.
- When strong light is directly coming on the camera, objects may not be displayed clearly. This is not a malfunction.
- Vertical lines may be seen in objects on the screen. This is due to strong reflected light from the bumper. This is not a malfunction.
- The screen may flicker under fluorescent light. This is not a malfunction.
- The colors of objects on the RearView Monitor may differ somewhat from the actual color of objects. This is not a malfunction.
- Objects on the monitor may not be clear in a dark environment. This is not a malfunction.

#### Backing up behind a projecting object

The position **(C)** is shown farther than the position **(B)** in the display. However, the position **(C)** is actually at the same distance as the position **(A)**. The vehicle may hit the object when backing up to

- If dirt, rain or snow accumulates on the camera, the RearView Monitor may not display object clearly. Clean the camera.
- Do not use alcohol, benzine or thinner to clean the camera. This will cause discoloration. To clean the camera, wipe with a cloth dampened with diluted mild cleaning agent and then wipe with a dry cloth.
- Do not damage the camera as the monitor screen may be adversely affected.
- Do not use wax on the camera window. Wipe off any wax with a clean cloth dampened with mild detergent diluted with water.

## AROUND VIEW® MONITOR (if so equipped)

With the ignition switch in the ON position, press the CAMERA button or move the shift lever to the R (Reverse) position to operate the Around View Monitor. The monitor displays various views of the position of the vehicle in a split screen format.

### WARNING

- **The Around View Monitor is a convenience feature. It is not a substitute for proper vehicle operation because it has areas where objects cannot be viewed. The four corners of the vehicle in particular are blind spots where objects do not appear in the bird's-eye, front or rear views. Always look out the windows and check with your own eyes to be sure that it is safe to move before operating the vehicle. Always operate the vehicle slowly.**
- **The driver is always responsible for safety during parking and other maneuvers.**
- **Do not use the Around View Monitor with the outside mirror in the stored position, and make sure that the liftgate is securely closed when operating the vehicle using the Around View Monitor.**

- **The distance between objects viewed on the Around View Monitor differs from the actual distance.**
- **The cameras are installed on the front grille, the outside mirrors and above the rear license plate. Do not put anything on the cameras.**
- **When washing the vehicle with high-pressure water, be sure not to spray it around the cameras. Otherwise, water may enter the camera unit causing water condensation on the lens, a malfunction, fire or an electric shock.**
- **Do not strike the cameras. They are precision instruments. Doing so could cause a malfunction or cause damage resulting in a fire or an electric shock.**

### Available views:

- **Bird's-Eye View**  
The surrounding view of the vehicle from above.
- **Front-Side View**  
The view around and ahead of the front passenger's side wheel.
- **Front View**  
The view to the front of the vehicle.

- **Rear View**  
The view to the rear of the vehicle.

The system is designed as an aid to the driver in situations such as slot parking or parallel parking.



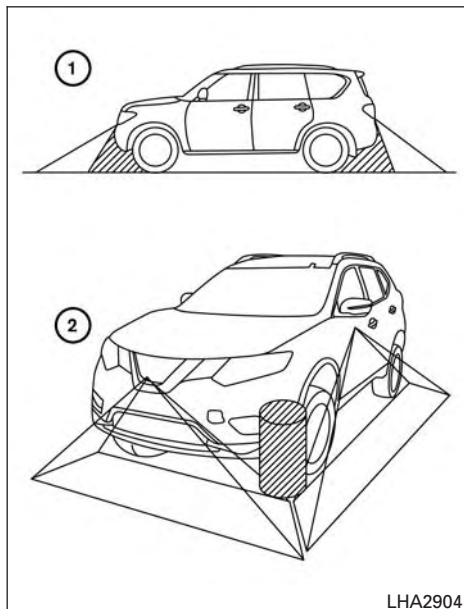

There are some areas where the system will not show objects. When in the front or rearview display, an object below the bumper or on the ground may not be viewed ①. When in the bird's-eye view, a tall object near the seam of the camera viewing areas will not appear in the monitor ②.

### ⚠ CAUTION

Do not scratch the camera lens when cleaning dirt or snow from the front of the camera.

### AVAILABLE VIEWS

### ⚠ WARNING

- The distance guide line and the vehicle width line should be used as a reference only when the vehicle is on a paved, level surface. The distance viewed on the monitor may be different than the actual distance between the vehicle and displayed objects.
- If the tires are replaced with different sized tires, the predictive course lines and the bird's-eye view may be displayed incorrectly.
- When driving the vehicle up a hill, objects viewed in the monitor are further than they appear. When driving the vehicle down a hill, objects viewed in the monitor are closer than they appear. Use the mirrors or actually look to properly judge distances to other objects.

- Objects in the rear view will appear visually opposite than when viewed in the rear view and outside mirrors.
- On a snow-covered or slippery road, there may be a difference between the predictive course lines and the actual course line.
- The vehicle width and predictive course lines are wider than the actual width and course.
- The displayed lines on the rear view will appear slightly off to the right, because the rear view camera is not installed in the rear center of the vehicle.
- Use the displayed lines and the bird-eye view as a reference. The lines and the bird-eye view are greatly affected by the number of occupants, fuel level, vehicle position, road condition and road grade.

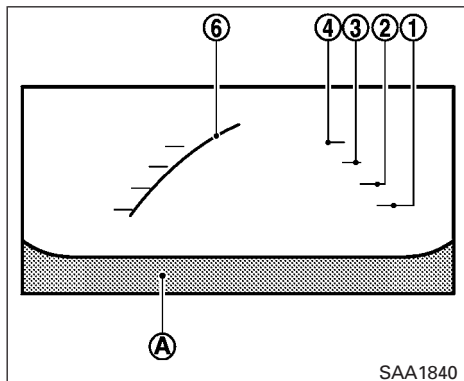

Front view

### Front and rearview

Guiding lines, which indicate the vehicle width and distance to objects with reference to the vehicle body line (A), are displayed on the monitor.

#### Distance guide lines:

Indicate distances from the vehicle body:

- Red line ①: approximately 1.5 ft (0.5 m)
- Yellow line ②: approximately 3 ft (1 m)
- Green line ③: approximately 7 ft (2 m)
- Green line ④: approximately 10 ft (3 m)

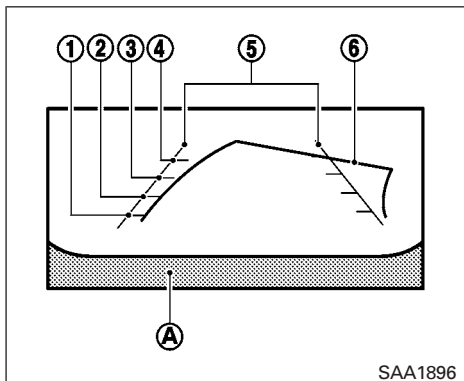

Rearview

### Vehicle width guide lines ⑤:

Indicate the vehicle width when backing up.

### Predictive course lines ⑥:

Indicate the predictive course when operating the vehicle. The predictive course lines will be displayed on the monitor when the steering wheel is turned. The predictive course lines will move depending on how much the steering wheel is turned and will not be displayed while the steering wheel is in the neutral position.

The front view will not be displayed when the vehicle speed is above 6 mph (10 km/h).

### NOTE:

When the monitor displays the front view and the steering wheel turns about 90 degrees or less from the neutral position, both the right and left predictive course lines ⑥ are displayed. When the steering wheel turns about 90 degrees or more, a line is displayed only on the opposite side of the turn.

### WARNING

- The distance between objects viewed in the rear view may differ from the actual distance. Objects in the rear view will appear visually opposite from those viewed in the inside and outside mirrors.
- On a snow-covered or slippery road, there may be a difference between the predictive course line and the actual course line.

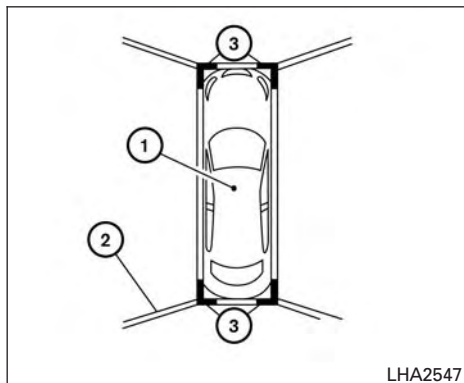

### Bird's-eye view

The bird's-eye view shows the overhead view of the vehicle, which helps confirm the vehicle position and the predicted course to a parking space.

The vehicle icon (1) shows the position of the vehicle. Note that the distance between objects viewed in the bird's-eye view differs from the actual distance.

The areas that the cameras cannot cover (2) are indicated in black.

After the ignition switch is placed in the ON position, the non-viewable area (2) is highlighted

in yellow for three seconds after the bird's-eye view is displayed. In addition, the non-viewable corners are displayed in red and blink for the first three seconds (3) to remind the driver to be cautious.

### ⚠ WARNING

- **Objects in the bird's-eye view will appear further than the actual distance because the bird's-eye view is a pseudo view that is processed by combining the views from the cameras on the outside mirrors, the front and the rear of the vehicle.**
- **Tall objects, such as a curb or vehicle, may be misaligned or not displayed at the seam of the views.**
- **Objects that are above the camera cannot be displayed.**
- **The view of the bird's-eye view may be misaligned when the camera position alters.**
- **A line on the ground may be misaligned and is not seen as being straight at the seam of the views. The misalignment will increase as the line proceeds away from the vehicle.**

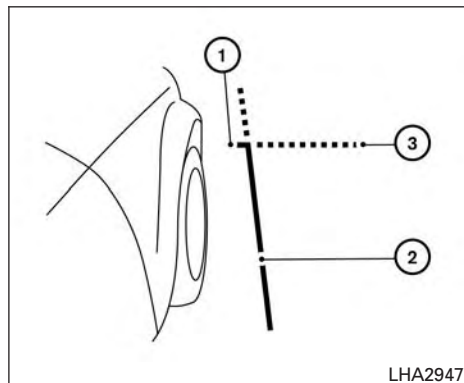

### Front-side view

#### Guiding lines:

Guiding lines that indicate the width and the front end of the vehicle are displayed on the monitor.

The front-of-vehicle line (1) shows the front part of the vehicle.

The side-of-vehicle line (2) shows the vehicle width including the outside mirror.

The extensions (3) of both the front (1) and side (2) lines are shown with a green dotted line.

**CAUTION**

- The turn signal light may look like the side-of-vehicle line. This is not a malfunction.

**DIFFERENCE BETWEEN PREDICTIVE AND ACTUAL DISTANCES**

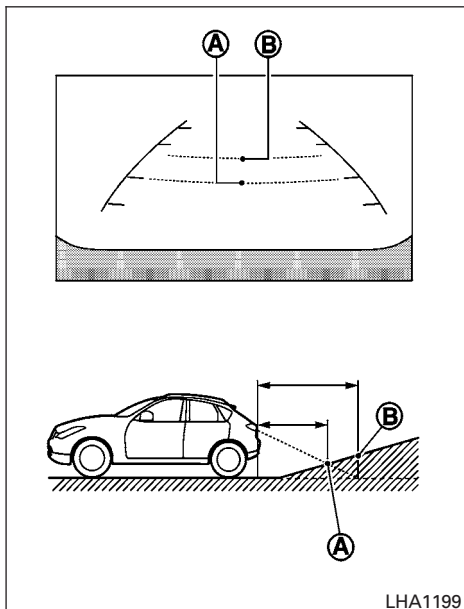

the hill is the place **(B)**. Note that any object on the hill is further than it appears on the monitor.

**Backing up on a steep uphill**

When backing up the vehicle up a hill, the distance guide lines and the vehicle width guide lines are shown closer than the actual distance. For example, the display shows 3 ft (1.0 m) to the place **(A)**, but the actual 3 ft (1.0 m) distance on

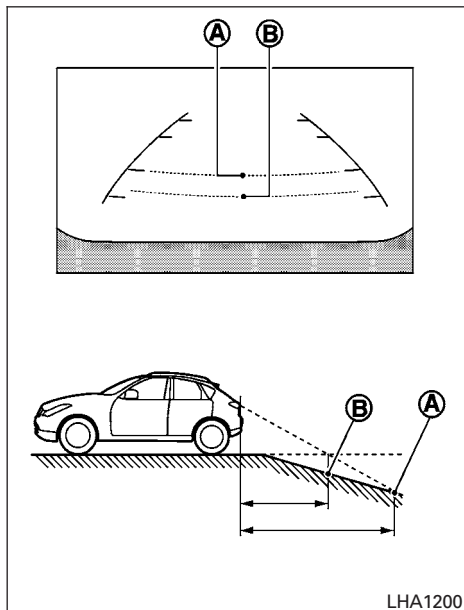

the hill is the place **B**. Note that any object on the hill is closer than it appears on the monitor.

### Backing up on a steep downhill

When backing up the vehicle down a hill, the distance guide lines and the vehicle width guide lines are shown farther than the actual distance. For example, the display shows 3 ft (1.0 m) to the place **A**, but the actual 3 ft (1.0 m) distance on

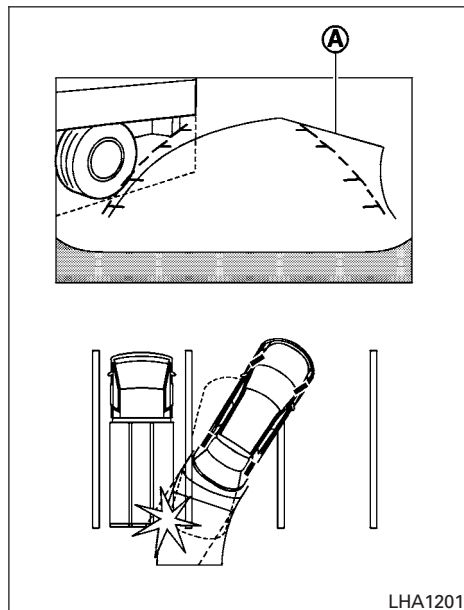

### Backing up near a projecting object

The predicted course lines **A** do not touch the object in the display. However, the vehicle may hit the object if it projects over the actual backing up course.

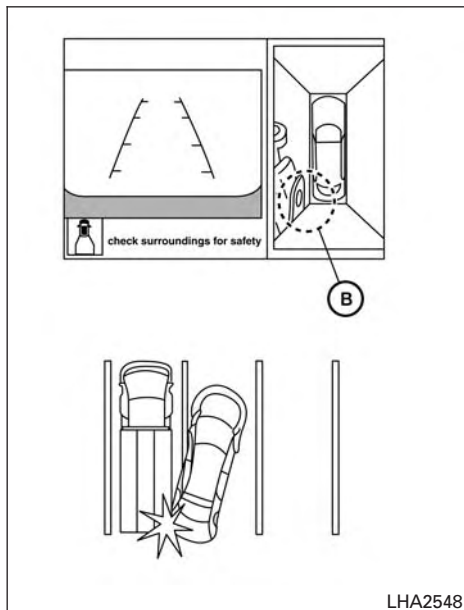

There may be a small distance visible between the vehicle and the object in the bird-eye view on the display (B).

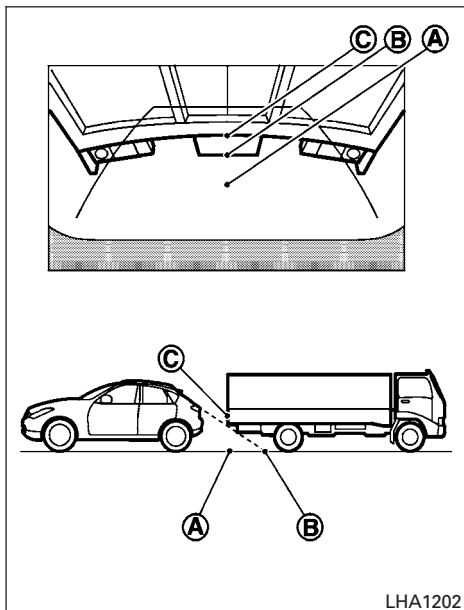

### Backing up behind a projecting object

The position (C) is shown farther than the position (B) in the display. However, the position (C) is actually at the same distance as the position (A). The vehicle may hit the object when backing up to

the position (A) if the object projects over the actual backing up course.

### HOW TO SWITCH THE DISPLAY

With the ignition switch in the ON position, press the CAMERA button or move the shift lever to the R (Reverse) position to operate the Around View Monitor.

The Around View Monitor displays different split screen views depending on the position of the shift lever. Press the CAMERA button to switch between the available views.

If the shift lever is in the R (Reverse) position, the available views are:

- Rear view/bird's-eye view split screen
- Rear view/front-side view split screen

If the shift lever is in the P (Park) position, the available views are:

- Front view/bird's-eye view split screen
- Front view/front-side view split screen

The display automatically changes to the Around View Monitor displaying front-view/bird's-eye view when:

- The shift lever is in the D (Drive) position, and the sonar detects the vehicle is approaching an object.

The display will switch from the Around View Monitor screen when:

- The shift lever is in the D (Drive) position and the vehicle speed increases above approximately 6 mph (10 km/h)
- The sonar no longer detects an object the screen will automatically switch back the previously displayed screen.
- A different screen is selected.

## HOW TO ADJUST THE CAMERA SETTINGS

To adjust the Display ON/OFF/AUTO, Brightness, Color and Contrast of the Around View Monitor, press the {APPS} button with the Around View Monitor on followed by the SETTINGS key on the touch screen. Next, touch the SYSTEM key and then the CAMERA DISPLAY SETTINGS key on the touch screen.

Do not adjust any of the CAMERA DISPLAY SETTINGS of the Around View Monitor while the vehicle is moving. Make sure the parking brake is firmly applied.

## MOVING OBJECT DETECTION (MOD) (if so equipped)

The MOD system can inform the driver of moving objects behind the vehicle when backing out of garages, maneuvering in parking lots and in other such instances.

The MOD system detects moving objects by using image processing technology on the image shown in the display.

The MOD system operates in the following conditions when the camera view is displayed:

- When the shift lever is in the P or N position and the vehicle is stopped, the MOD system detects the moving objects in the bird-eye view. The MOD system will not operate if the outside mirror is moving in or out or if either door is opened.
- When the shift lever is in the D position and the vehicle speed is below approximately 5 mph (8 km/h), the MOD system detects moving objects in the front view or front-wide view.
- When the shift lever is in the R position and the vehicle speed is below approximately 5 mpg (8 km/h), the MOD system detects moving objects in the rear view. MOD system will not operate if the liftgate is open.

The MOD system does not detect moving objects in the front-side view. The MOD system icon is not displayed on the screen when in this view.

### WARNING

- **The MOD system is not a substitute for proper vehicle operation and does not prevent contact with the objects surrounding the vehicle. When maneuvering, always use the outside mirror and rear view mirror and turn and look to check the surroundings to make sure it is safe to maneuver.**
- **The MOD system is not designed to detect surrounding stationary objects.**

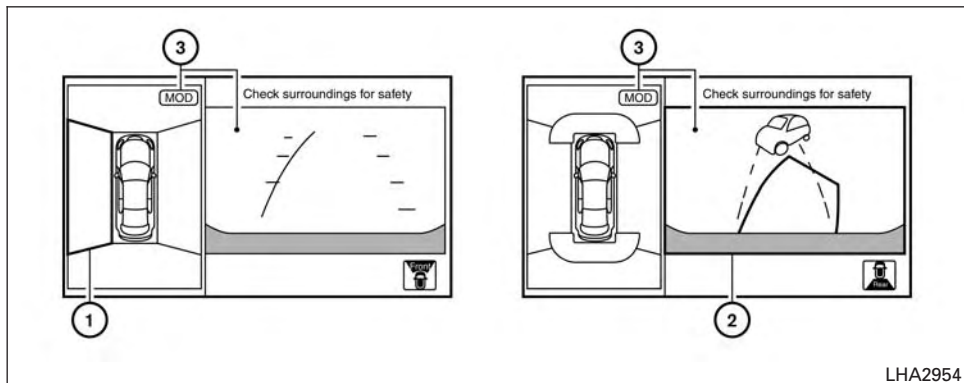

If the MOD system detects the moving objects surrounding the vehicle, the yellow frame will be displayed on the camera image and a chime sounds.

When the MOD system detects a moving object surrounding the vehicle, the yellow frame will be displayed on the view where the objects are detected and a chime will sound once. While the MOD system continues to detect moving objects, the yellow frame continues to be displayed.

In the bird's-eye view, the yellow from ① is displayed on each camera image (front, rear, right, left) depending on where moving objects are detected.

The yellow frame ② is displayed on each view in the front view, rear view modes.

A blue MOD icon is displayed in the view where the MOD system is operative. A gray MOD icon is displayed in the view where the MOD system is not operative.



If the MOD system is turned off, the MOD icon ③ is not displayed.

### Turning the MOD system on or off

The MOD system is turned on or off using the settings menu in the vehicle information display.

A blue MOD icon is displayed if the MOD is operative.

A gray MOD icon is displayed if the MOD is not operative.

1. Press the  button until "Settings" displays in the vehicle information display. Use the  to select "Driver Assistance". Then press the ENTER button.
2. Select "Parking Aids", and press the ENTER button.
3. To set the MOD system to on or off, use the  buttons to navigate in the menu and use the ENTER button to select or change an item:
  - To turn off the warning, use the ENTER button to check box for "Moving Object"

If the MOD system is turned off, the MOD icon is not displayed.



## Moving Object Detection (MOD) malfunction

### WARNING

- Do not use the MOD system when towing a trailer. The system may not function properly.
- Excessive noise (for example, audio system volume or open vehicle window) will interfere with the chime sound, and it may not be heard.
- The MOD system performance will be limited according to environmental conditions and surrounding objects such as:
  - When there is low contrast between background and the moving objects.
  - When there is blinking source of light.
  - When strong light such as another vehicle's headlight or sunlight is present.
  - When there is dirt, water drops or snow on the camera lens.
  - When the position of the moving objects in the display is not changed.

- The MOD system might detect something like flowing water droplets on the camera lens, white smoke from the muffler, moving shadows, etc.
- The MOD system may not function properly depending on the speed, direction, distance or shape of the moving objects.
- If your vehicle sustains damage to the parts where the camera is installed, leaving it misaligned or bent, the sensing zone may be altered and the MOD system may not detect objects properly.

When the orange MOD icon is displayed in the view, the system is not functioning properly. This will not hinder normal driving operation but the system should be inspected by a NISSAN dealer.

### Camera Maintenance

If dirt, rain or snow accumulates on the camera, the MOD system may not operate properly. Clean the camera.

## OPERATING TIPS

### CAUTION

- Do not use alcohol, benzene or thinner to clean the camera. This will cause discoloration. To clean the camera, wipe with a cloth dampened with a diluted mild cleaning agent and then wipe with a dry cloth.
- Do not damage the camera as the monitor screen may be adversely affected.
- The screen displayed on the Around View Monitor will automatically return to the previous screen three minutes after the CAMERA button has been pressed with the shift lever in a position other than the R (Reverse) position.
- When the view is switched, the display images on the screen may be displayed in some delay.
- When the temperature is extremely high or low, the screen may not display objects clearly. This is not a malfunction.
- When strong light directly shines on the camera, objects may not be displayed clearly. This is not a malfunction.

## VENTS

- The screen may flicker under fluorescent light. This is not a malfunction.
- The colors of objects on the Around View Monitor may differ somewhat from the actual color of objects. This is not a malfunction.
- Objects on the Around View Monitor may not be clear and the color of the object may differ in a dark environment. This is not a malfunction.
- There may be differences in sharpness between each camera view of the bird's-eye view.
- If dirt, rain or snow accumulates on the camera, the Around View Monitor may not display objects clearly. Clean the camera.
- Do not use wax on the camera lens. Wipe off any wax with a clean cloth that has been dampened with a mild detergent diluted with water.

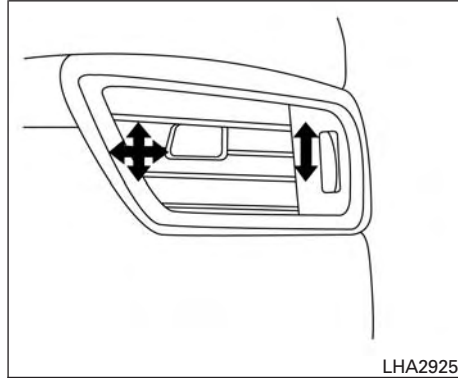

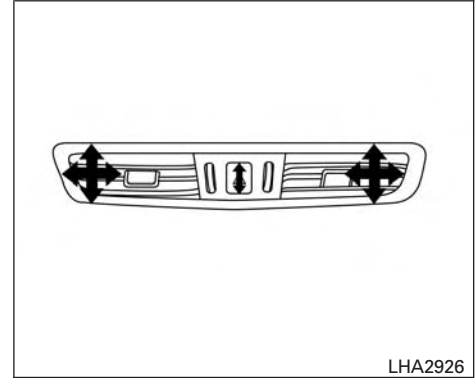

Side



Center

Adjust air flow direction by moving the vent slides.

Open or close the vents by using the dial. Move the dial toward the  to open the vents or toward the  to close them.

## HEATER AND AIR CONDITIONER (manual) (if so equipped)

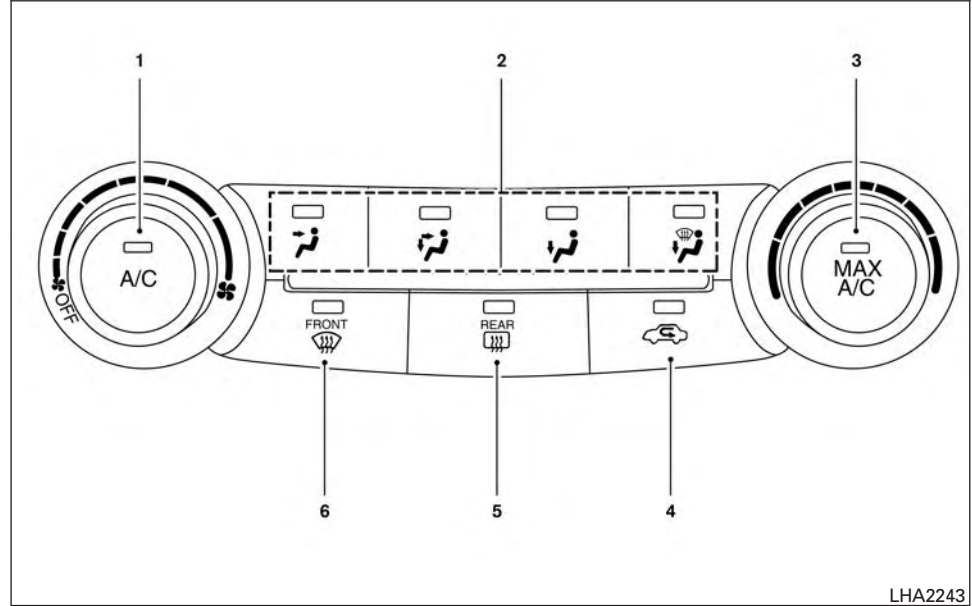
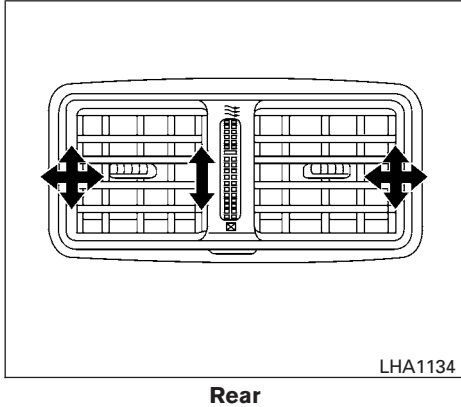

1. Fan speed control / system OFF dial / air conditioning (A/C) button
2. Air flow control buttons
3. Temperature control dial / MAX A/C button
4. Air recirculation button
5. Rear window defroster button
6. Front windshield defrost button

## WARNING

- **The air conditioner cooling function operates only when the engine is running.**
- **Do not leave children or adults who would normally require the assistance of others alone in your vehicle. Pets should also not be left alone. They could accidentally injure themselves or others through inadvertent operation of the vehicle. Also, on hot, sunny days, temperatures in a closed vehicle could quickly become high enough to cause severe or possibly fatal injuries to people or animals.**
- **Do not use the recirculation mode for long periods as it may cause the interior air to become stale and the windows to fog up.**

## NOTE:

- Odors from inside and outside the vehicle can build up in the air conditioner unit. Odor can enter the passenger compartment through the vents.

- When parking, set the heater and air conditioner controls to turn off air recirculation to allow fresh air into the passenger compartment. This should help reduce odors inside the vehicle.

## CONTROLS

### Fan control dial

The fan control dial turns the fan on and off, and controls fan speed.

### Air flow control buttons

The air flow control buttons allow you to select the air flow outlets.

MAX — Air flows mainly from center and side vents with maximum cooling and  turns on.

 — Air flows mainly from center and side vents.

 — Air flows mainly from center and side vents and foot outlets.

 — Air flows mainly from foot outlets and partly from defroster.

 — Air flows mainly from defroster outlets and foot outlets.

 — Air flows mainly from defroster outlets.

### Temperature control dial

The temperature control dial allows you to adjust the temperature of the outlet air. To lower the temperature, turn the dial to the left. To increase the temperature, turn the dial to the right.



Air recirculation button

### On position (Indicator light on):

Interior air is recirculated inside the vehicle.

Press the  button to the ON position when:

- driving on a dusty road.
- to prevent traffic fumes from entering passenger compartment.
- for maximum cooling when using the air conditioner.

### Off position (Indicator light off):

Outside air is drawn into the passenger compartment and distributed through the selected outlet.

Use the off position for normal heater or air conditioner operation.

## A/C Air conditioner button

Start the engine, turn the fan control dial to the desired position and press the A/C button to turn on the air conditioner. The indicator light comes on when the air conditioner is operating. To turn off the air conditioner, press the A/C button again.

### The air conditioner cooling function operates only when the engine is running.



## Rear window and outside mirror (if so equipped) defroster switch

For more information about the rear window and outside mirror (if so equipped) defroster switch, see "Rear window and outside mirror defroster switch" in the "Instruments and controls" section of this manual.

## HEATER OPERATION

### Heating



This mode is used to direct heated air to the foot outlets. Some air also flows from the defrost outlets and the side vent outlets.

1. Press the  button to change to fresh air intake mode. The  indicator light will turn off for normal heating.

2. Press the  air flow control button.
3. Turn the fan control dial to the desired position.
4. Turn the temperature control dial to the desired position between the middle and the hot position.

### Ventilation

This mode directs outside air to the side and center vents.



1. Press the  button to change to fresh air intake mode. The  indicator light will turn off.
2. Press the  air flow control button.
3. Turn the fan control dial to the desired position.
4. Turn the temperature control dial to the desired position.

### Defrosting or defogging

This mode directs the air to the defrost outlets to defrost/defog the windows.



1. Press the defrost/defog button .
2. Turn the fan control dial to the desired position.

3. Turn the temperature control dial to the desired position between the middle and the hot position.

- To quickly remove ice or fog from the windows, turn the fan control dial to the highest setting and the temperature control to the full HOT position.
- When the  position is selected, the air conditioner automatically turns on if the outside temperature is more than 36°F (2°C). This dehumidifies the air which helps defog the windshield. The  indicator automatically turns off, allowing outside air to be drawn into the passenger compartment to further improve the defogging performance. The recirculation mode cannot be activated in the  position.

### Bi-level heating



The bi-level mode directs warmed air to the side and center vents and to the front and rear floor outlets.

1. Press the  button to change to fresh air intake mode. The  will turn off.
2. Press the  air flow control button.
3. Turn the fan control dial to the desired position.

4. Turn the temperature control dial to the desired position.

## Heating and defogging

This mode heats the interior and defogs the windshield.

1. Press the  air flow control button.
2. Turn the fan control dial to the desired position.
3. Turn the temperature control dial to the desired position between the middle and the hot position.
  - When the  position is selected, the air conditioner automatically turns on if the outside temperature is more than 36°F (2°C). The indicator light on the A/C button will come on. This dehumidifies the air which helps defog the windshield. The  indicator automatically turns off, allowing outside air to be drawn into the passenger compartment to further improve the defogging performance.

## Operating tips

**Clear snow and ice from the wiper blades and air inlet in front of the windshield. This improves heater operation.**



## AIR CONDITIONER OPERATION

Start the engine, turn the fan control dial to the desired position, and press the  button to activate the air conditioner. When the air conditioner is on, cooling and dehumidifying functions are added to the heater operation.

**The air conditioner cooling function operates only when the engine is running.**



### Cooling

This mode is used to cool and dehumidify the air.

1. Press the  air flow control button.
2. Turn the fan control dial to the desired position.
3. Push the  button. The indicator light comes on.
4. Turn the temperature control dial to the desired position.
  - For quick cooling, push the MAX A/C button. When the MAX A/C button is pushed, the MAX A/C indicator light will turn on. It will also activate the  mode. The amount of air coming through the vents is the highest it can go when in MAX A/C mode regardless of the position of the FAN dial. The A/C indicator light will turn on for this mode.

## Dehumidified heating





This mode is used to heat and dehumidify the air.

1. Press the  button to the OFF position.
2. Press the  air flow control button.
3. Turn the fan control dial to the desired position.
4. Push the  button. The indicator light comes on.
5. Turn the temperature control dial to the desired position.

## Dehumidified defogging

This mode is used to defog the windows and dehumidify the air.

1. Press the  air flow control button.
2. Turn the fan control dial to the desired position.

- When the  or  are selected, the air conditioner automatically turns on (the indicator light may or may not illuminate) if the outside temperature is more than 36°F (2°C). This dehumidifies the air which helps defog the windshield. The  mode automatically turns off, allowing outside air to be drawn into the passenger compartment to further improve the defogging performance.
  - The air conditioner is always on in  or  mode, regardless of whether the indicator light is on or off.
3. Turn the temperature control dial to the desired position.

### Operating tips

- Keep the windows and moonroof closed while the air conditioner is in operation.
- After parking in the sun, drive for 2 or 3 minutes with the windows open to vent hot air from the passenger compartment. Then, close the windows. This allows the air conditioner to cool the interior more quickly.

- **The air conditioning system should be operated for approximately 10 minutes at least once a month. This helps prevent damage to the system due to lack of lubrication.**
- A visible mist may be seen coming from the ventilators in hot, humid conditions as the air is cooled rapidly. This does not indicate a malfunction.
- **If the engine coolant temperature gauge indicates engine coolant temperature over the normal range, turn the air conditioner off. See “If your vehicle overheats” in the “In case of emergency” section of this manual.**
- If the engine coolant temperature becomes too high,  will be activated and the indicator light will come on automatically.
- When IGN is OFF, button characters will not illuminate.

### AIR FLOW CHARTS

The following charts show the button and dial positions for **MAXIMUM AND QUICK** heating, cooling or defrosting. **The air recirculation indicator should always be in the OFF position for heating and defrosting.**

### Defrosting/ Defogging

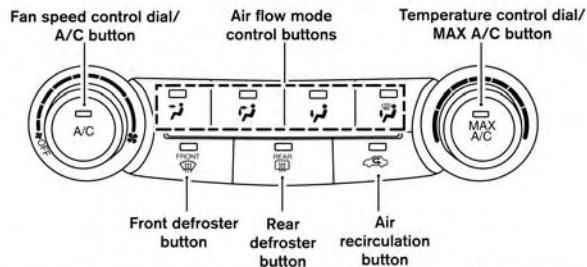
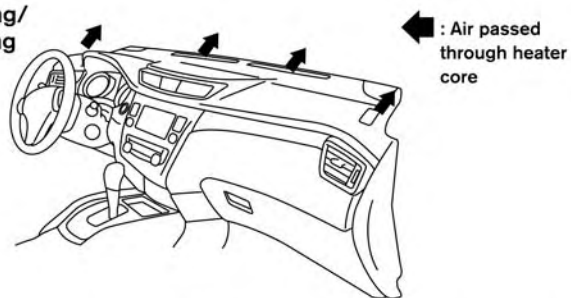

Fan control	Air recirculation button	A/C button	Temp. control	Air flow control
HI	OFF	Turns on automatically (indicator may or may not turn on)	HOT (RIGHT)	

LHA2880

### Bi-level Heating

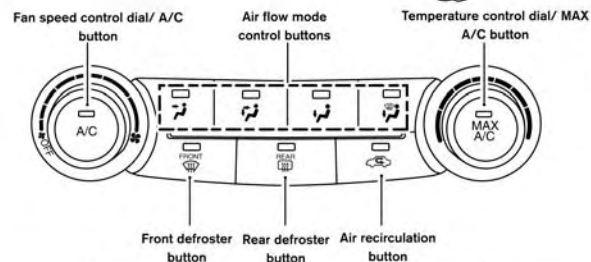
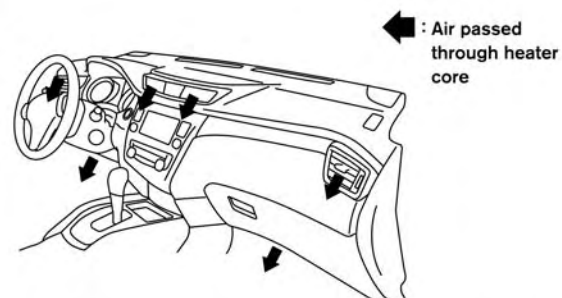

Fan control	Air recirculation button	A/C button	Temp. control	Air flow control
HI	OFF	OFF	HOT (RIGHT)	

LHA2881



## Heating

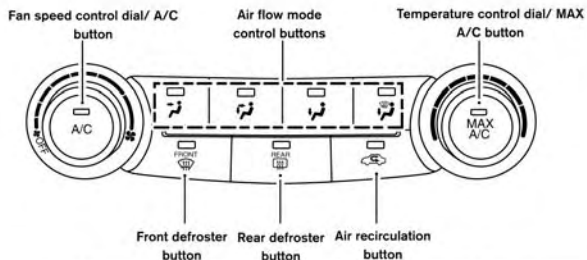
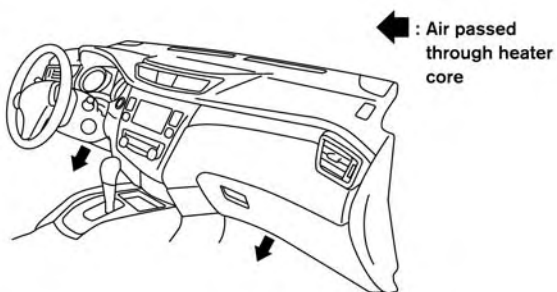

Fan control	Air recirculation button	A/C button	Temp control	Air flow control
HI	OFF	OFF	HOT (RIGHT)	

LHA2882

## Heating & Defrosting/Defogging

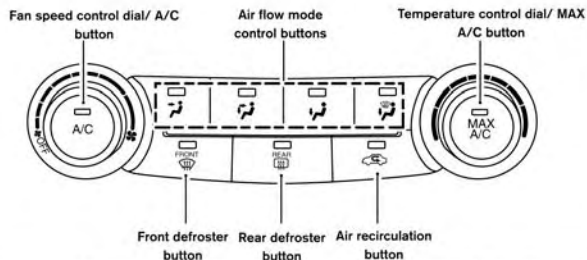
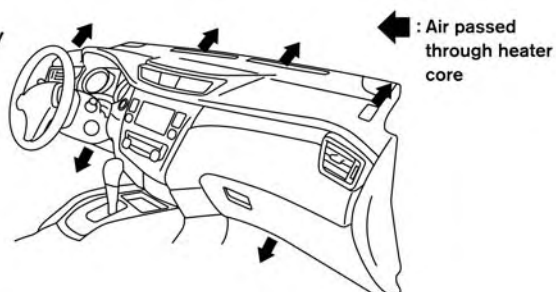

Fan control	Air recirculation button	A/C button	Temp. control	Air flow control
HI	OFF	Turns on automatically (indicator may or may not turn on)	HOT (RIGHT)	

LHA2883

## Cooling

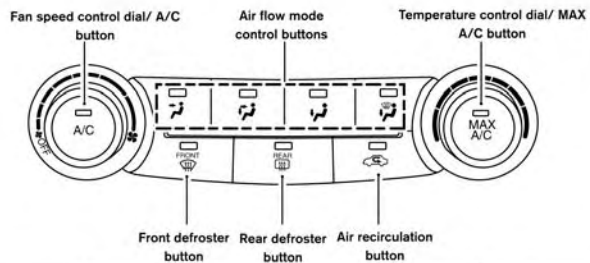
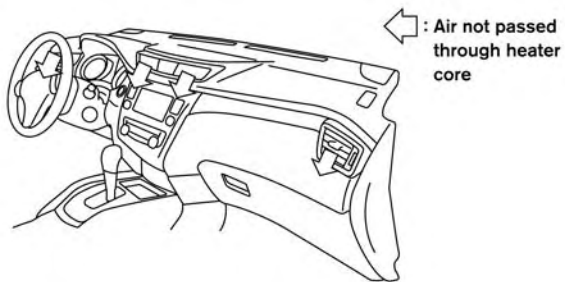



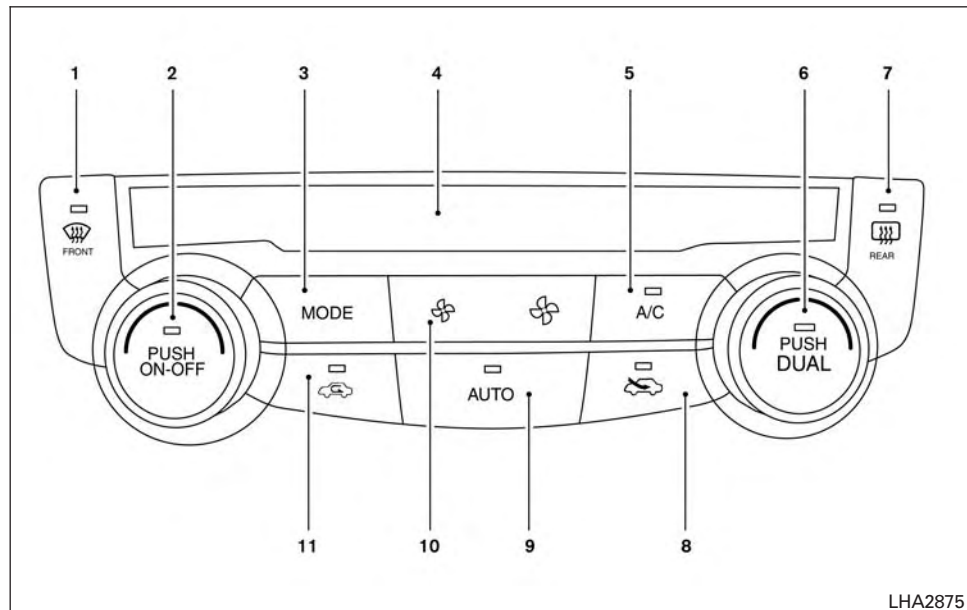

Fan control	Air recirculation button	A/C button	Temp. control	Air flow control
HI	ON	ON	COLD (LEFT)	MAX A/C

LHA2884

## HEATER AND AIR CONDITIONER (automatic) (if so equipped)



1.  (front defroster) button
2. Temperature control dial (driver's side) / ON-OFF button
3. MODE (manual air flow control) button
4. Display screen
5. A/C (air conditioner) button
6. Temperature control dial (passenger's side)/DUAL (passenger's side temperature control) button
7.  (rear window defroster) button
8.  Fresh air intake button
9. AUTO (automatic mode) button
10.  (fan speed control) buttons
11.  Air recirculation button

### WARNING

- The air conditioner cooling function operates only when the engine is running.
- Do not leave children or adults who would normally require the assistance of others alone in your vehicle. Pets should also not be left alone. They could accidentally injure themselves or others through inadvertent operation of the vehicle. Also, on hot, sunny days, temperatures in a closed vehicle could quickly become high enough to cause severe or possibly fatal injuries to people or animals.
- Do not use the recirculation mode for long periods as it may cause the interior air to become stale and the windows to fog up.

## NOTE:

- Odors from inside and outside the vehicle can build up in the air conditioner unit. Odor can enter the passenger compartment through the vents.
- When parking, set the heater and air conditioner controls to turn off air recirculation to allow fresh air into the passenger compartment. This should help reduce odors inside the vehicle.

## AUTOMATIC OPERATION

### Cooling and/or dehumidified heating (AUTO)

This mode may be used all year round as the system automatically works to keep a constant temperature. Air flow distribution and fan speed are also controlled automatically.

1. Press the AUTO button on. The indicator on the button will illuminate.
  2. Turn the temperature control dial to the left or right to set the desired temperature.
- The temperature of the passenger compartment will be maintained automatically. Air flow distribution and fan speed are also controlled automatically.

- A visible mist may be seen coming from the vents in hot, humid conditions as the air is cooled rapidly. This does not indicate a malfunction.
- 3. You can individually set driver's and front passenger's side temperature using each temperature control dial. When the DUAL button or passenger's side temperature dial is turned, the DUAL indicator will come on. To turn off the passenger's side temperature control, press the DUAL button.



### Heating (A/C OFF)

The air conditioner does not activate. When you need to heat only, use this mode.

1. Press the A/C button. The A/C indicator will turn off.
  2. Turn the temperature control dial to set the desired temperature.
- The temperature of the passenger compartment will be maintained automatically. Air flow distribution and fan speed are also controlled automatically.
  - Do not set the temperature lower than the outside air temperature. Otherwise, the system may not work properly.

- Not recommended if windows fog up.

### Dehumidified defrosting or defogging

1. Press the  front defroster button on. The indicator light on the button will come on.
  2. Turn the temperature control dial to set the maximum temperature to aid in defrosting or defogging.
- To quickly remove ice from the outside of the windows, use the fan speed control dial to set the fan speed to maximum.
  - As soon as possible after the windshield is clean, press the AUTO button to return to the automatic mode.
  - When the  front defroster button is pressed, the air conditioner will automatically be turned on at outside temperatures above 36°F (2°C). The indicator light may or may not illuminate. The air recirculate mode automatically turns off, allowing outside air to be drawn into the passenger compartment to further improve the defogging performance. When the air recirculate mode automatically turns off, the air fresh mode will automatically turn on.



## MANUAL OPERATION



### Fan speed control

Press the fan control buttons  to manually control the fan speed.



Press the AUTO button to return to automatic control of the fan speed.

### Air recirculation

Press the  air recirculation button to recirculate interior air inside the vehicle. The  indicator light on the button will come on.





The air recirculation cannot be activated when the air conditioner is in the  front defrosting mode or the  front defrosting and foot outlet mode.

### Fresh air intake

Press the  fresh air intake button to draw outside air into the passenger compartment. The  indicator light on the button will come on.

## Air flow control

Pressing the MODE button manually controls air flow and selects the air outlet:

-  — Air flows mainly from center and side vents.
-  — Air flows mainly from center and side vents and foot outlets.
-  — Air flows mainly from foot outlets and partly from defroster.
-  — Air flows mainly from defroster and foot outlets.

## To turn system off

Press the OFF button.

## Rear window and outside mirror (if so equipped) defroster switch

For more information about the rear window and outside mirror (if so equipped) defroster switch, see "Rear window and outside mirror defroster switch" in the "Instruments and controls" section of this manual.

## OPERATING TIPS

- When the engine coolant temperature and outside air temperature are low, the air flow from the foot outlets may not operate for a maximum of 150 seconds. However, this is not a malfunction. After the coolant temperature warms up, air flow from the foot outlets will operate normally.
- Keep the moonroof closed while the air conditioner is in operation.
- If you feel that the air flow mode you have selected and the outlets the air is coming out do not match, select the  mode.
- When you change the air flow mode, you may feel air flow from the feet vents for just a moment. This is not a malfunction.

## SERVICING AIR CONDITIONER

The air conditioner system in your NISSAN vehicle is charged with a refrigerant designed with the environment in mind.

**This refrigerant does not harm the earth's ozone layer.**

Special charging equipment and lubricant is required when servicing your NISSAN air conditioner. Using improper refrigerants or lubricants will cause severe damage to your air conditioner system. See "Air conditioner system refrigerant and oil recommendations" in the "Technical and consumer information" section of this manual.

A NISSAN dealer is able to service your "environmentally friendly" air conditioning system.

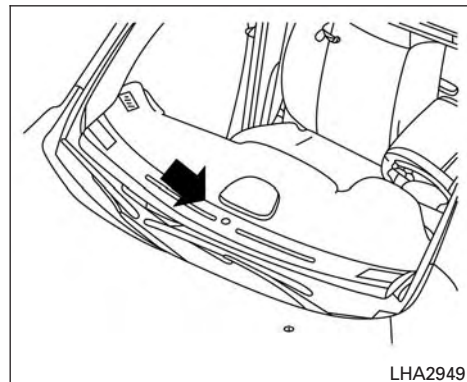

The sunload sensor, located on the top and center of the instrument panel, helps the system maintain a constant temperature. Do not put anything on or around this sensor.

### WARNING

**The air conditioner system contains refrigerant under high pressure. To avoid personal injury, any air conditioner service should be done only by an experienced technician with proper equipment.**

## AUDIO SYSTEM

### RADIO

With the ignition placed in the ACC or ON position, press the POWER button/VOLUME control knob to turn the radio on. If you listen to the radio with the engine not running, the ignition should be placed in the ACC position.

Radio reception is affected by station signal strength, distance from radio transmitter, buildings, bridges, mountains and other external influences. Intermittent changes in reception quality normally are caused by these external influences.

**Using a cellular phone in or near the vehicle may influence radio reception quality.**

### Radio reception

Your NISSAN radio system is equipped with state-of-the-art electronic circuits to enhance radio reception. These circuits are designed to extend reception range, and to enhance the quality of that reception.

However, there are some general characteristics of both FM and AM radio signals that can affect radio reception quality in a moving vehicle, even when the finest equipment is used. These characteristics are completely normal in a given reception area and do not indicate any malfunction in your NISSAN radio system.

Reception conditions will constantly change because of vehicle movement. Buildings, terrain, signal distance and interference from other vehicles can work against ideal reception. Described below are some of the factors that can affect your radio reception.

Some cellular phones or other devices may cause interference or a buzzing noise to come from the audio system speakers. Storing the device in a different location may reduce or eliminate the noise.

## FM RADIO RECEPTION

Range: FM range is normally limited to 25 – 30 mi (40 – 48 km), with monaural (single channel) FM having slightly more range than stereo FM. External influences may sometimes interfere with FM station reception even if the FM station is within 25 mi (40 km). The strength of the FM signal is directly related to the distance between the transmitter and receiver. FM signals follow a line-of-sight path, exhibiting many of the same characteristics as light. For example, they will reflect off objects.

Fade and drift: As your vehicle moves away from a station transmitter, the signals will tend to fade and/or drift.

Static and flutter: During signal interference from buildings, large hills or due to antenna position (usually in conjunction with increased distance from the station transmitter), static or flutter can be heard. This can be reduced by adjusting the treble control to reduce treble response.

Multipath reception: Because of the reflective characteristics of FM signals, direct and reflected signals reach the receiver at the same time. The signals may cancel each other, resulting in momentary flutter or loss of sound.

## AM RADIO RECEPTION

AM signals, because of their low frequency, can bend around objects and skip along the ground. In addition, the signals can be bounced off the ionosphere and bent back to earth. Because of these characteristics, AM signals are also subject to interference as they travel from transmitter to receiver.

Fading: Occurs while the vehicle is passing through freeway underpasses or in areas with many tall buildings. It can also occur for several seconds during ionospheric turbulence even in areas where no obstacles exist.

Static: Caused by thunderstorms, electrical power lines, electric signs and even traffic lights.

## SATELLITE RADIO RECEPTION (if so equipped)

When the satellite radio is used for the first time or the battery has been replaced, the satellite radio may not work properly. This is not a malfunction. Wait more than 10 minutes with satellite radio ON and the vehicle outside of any metal or large building for satellite radio to receive all of the necessary data.

No satellite radio reception is available and "NO SAT" is displayed when the SAT band option is selected unless optional satellite receiver and antenna are installed and a SiriusXM® Satellite Radio service subscription is active. Satellite radio is not available in Alaska, Hawaii and Guam.

Satellite radio performance may be affected if cargo carried on the roof blocks the satellite radio signal.

If possible, do not put cargo over the satellite antenna.

A build up of ice on the satellite radio antenna can affect satellite radio performance. Remove the ice to restore satellite radio reception.

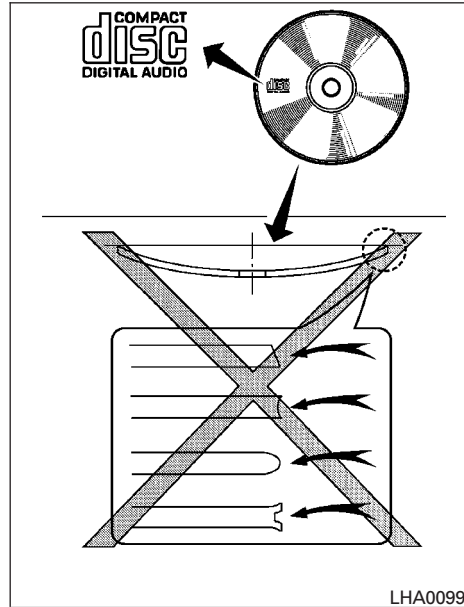

## AUDIO OPERATION PRECAUTIONS

### Compact disc (CD) player

#### ⚠ CAUTION

- Do not force a compact disc into the CD insert slot. This could damage the CD and/or CD player.
- Trying to load a CD with the CD door closed could damage the CD and/or CD player.
- Only one CD can be loaded into the CD player at a time.
- Only use high quality 4.7 in (12 cm) round discs that have the “COMPACT disc DIGITAL AUDIO” logo on the disc or packaging.
- During cold weather or rainy days, the player may malfunction due to the humidity. If this occurs, remove the CD and dehumidify or ventilate the player completely.
- The player may skip while driving on rough roads.
- The CD player sometimes cannot function when the compartment temperature is extremely high or low. Decrease/increase the temperature before use.
- Do not expose the CD to direct sunlight.
- CDs that are in poor condition or are dirty, scratched or covered with fingerprints may not work properly.
- The following CDs may not work properly:
  - Copy control compact discs (CCCD)
  - Recordable compact discs (CD-R)
  - Rewritable compact discs (CD-RW)
- Do not use the following CDs as they may cause the CD player to malfunction:
  - 3.1 in (8 cm) discs with an adapter
  - CDs that are not round
  - CDs with a paper label
  - CDs that are warped, scratched, or have abnormal edges
- This audio system can only play pre-recorded CDs. It has no capability to record or burn CDs.
- If the CD cannot be played, one of the following messages will be displayed.



#### **CHECK DISC:**

- **Confirm that the CD is inserted correctly (the label side is facing up, etc.).**
- **Confirm that the CD is not bent or warped and it is free of scratches.**

#### **PRESS EJECT:**

**This is an error due to excessive temperature inside the player. Remove the CD by pressing the EJECT button. After a short time, reinsert the CD. The CD can be played when the temperature of the player returns to normal.**

#### **UNPLAYABLE:**

**The file is unplayable in this audio system (only MP3 or WMA (if so equipped) CD).**

### Compact disc with MP3 or WMA

#### **Terms:**

- **MP3** — MP3 is short for Moving Pictures Experts Group Audio Layer 3. MP3 is the most well-known compressed digital audio file format. This format allows for near “CD quality” sound, but at a fraction of the size of normal audio files. MP3 conversion of an audio track from CD-ROM can reduce the file size by approximately a 10:1 ratio with virtually no perceptible loss in quality. MP3 compression removes the redundant and irrelevant parts of a sound signal that the human ear doesn’t hear.
- **WMA** — Windows Media Audio (WMA)\* is a compressed audio format created by Microsoft as an alternative to MP3. The WMA codec offers greater file compression than the MP3 codec, enabling storage of more digital audio tracks in the same amount of space when compared to MP3s at the same level of quality.
- **Bit rate** — Bit rate denotes the number of bits per second used by a digital music file. The size and quality of a compressed digital audio file is determined by the bit rate used when encoding the file.

- **Sampling frequency** — Sampling frequency is the rate at which the samples of a signal are converted from analog to digital (A/D conversion) per second.
- **Multisession** — Multisession is one of the methods for writing data to media. Writing data once to the media is called a single session, and writing more than once is called a multisession.
- **ID3/WMA Tag** — The ID3/WMA tag is the part of the encoded MP3 or WMA file that contains information about the digital music file such as song title, artist, encoding bit rate, track time duration, etc. ID3 tag information is displayed on the Artist/song title line on the display.

\* Windows® and Windows Media® are registered trademarks and trademarks in the United States of America and other countries of Microsoft Corporation of the USA.

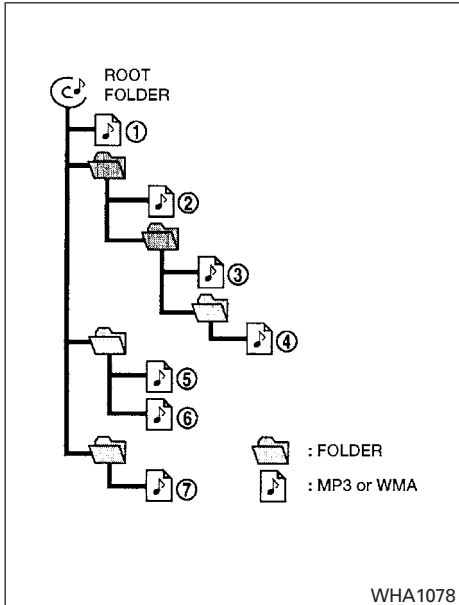

**Playback order chart**

### **Playback order:**

Music playback order of a CD with MP3 or WMA files is as illustrated.

- The names of folders not containing MP3 or WMA files are not shown in the display.
- If there is a file in the top level of the disc, "Root Folder" is displayed.
- The playback order is the order in which the files were written by the writing software. Therefore, the files might not play in the desired order.

## Specification chart:

Supported media		CD, CD-R, CD-RW	
Supported file systems		ISO9660 LEVEL1, ISO9660 LEVEL2, Apple ISO, Romeo, Joliet * ISO9660 Level 3 (packet writing) is not supported.	
Supported versions*1	MP3	Version	MPEG1, MPEG2, MPEG2.5
		Sampling frequency	8 kHz - 48 kHz
		Bit rate	8 kbps - 320 kbps, VBR
	WMA	Version	WMA7, WMA8, WMA9
		Sampling frequency	32 kHz - 48 kHz
		Bit rate	48 kbps - 192 kbps, VBR
Tag information		ID3 tag VER1.0, VER1.1, VER2.2, VER2.3 (MP3 only)	
Folder levels		Folder levels: 8, Max folders: 255 (including root folder), Files: 512 (Max. 255 files for one folder)	
Text character number limitation		128 characters	
Displayable character codes*2		01: ASCII, 02: ISO-8859-1, 03: UNICODE (UTF-16 BOM Big Endian), 04: UNICODE (UTF-16 Non-BOM Big Endian), 05: UNICODE (UTF-8), 06: UNICODE (Non-UTF-16 BOM Little Endian)	

\*1 Files created with a combination of 48 kHz sampling frequency and 64 kbps bit rate cannot be played.

\*2 Available codes depend on what kind of media, versions and information are going to be displayed.

## Troubleshooting guide:

Symptom	Cause and Countermeasure
Cannot play	Check if the disc was inserted correctly.
	Check if the disc is scratched or dirty.
	Check if there is condensation inside the player. If there is, wait until the condensation is gone (about 1 hour) before using the player.
	If there is a temperature increase error, the CD player will play correctly after it returns to the normal temperature.
	If there is a mixture of music CD files (CD-DA data) and MP3/WMA files on a CD, only the music CD files (CD-DA data) will be played.
	Files with extensions other than ".MP3", ".WMA", ".mp3" or ".wma" cannot be played. In addition, the character codes and number of characters for folder names and file names should be in compliance with the specifications.
	Check if the finalization process, such as session close and disc close, is done for the disc.
Poor sound quality	Check if the disc is scratched or dirty.
	Bit rate may be too low.
It takes a relatively long time before the music starts playing.	If there are many folders or file levels on the MP3/WMA disc, or if it is a <u>multisession disc</u> , some time may be required before the music starts playing.
Music cuts off or skips	The writing software and hardware combination might not match, or the writing speed, writing depth, writing width, etc., might not match the specifications. Try using the slowest writing speed.
Skipping with high bit rate files	Skipping may occur with large quantities of data, such as for high bit rate data.
Moves immediately to the next song when playing	When a non-MP3/WMA file has been given an extension of ".MP3", ".WMA", ".mp3" or ".wma", or when play is prohibited by copyright protection, there will be approximately 5 seconds of no sound and then the player will skip to the next song.
Songs do not play back in the desired order	The playback order is the order in which the files were written by the writing software. Therefore, the files might not play in the desired order.

## USB (Universal Serial Bus) memory

### WARNING

**Do not connect, disconnect, or operate the USB device while driving. Doing so can be a distraction. If distracted you could lose control of your vehicle and cause an accident or serious injury.**

### CAUTION

- **Do not force the USB device into the USB port. Inserting the USB device tilted or up-side-down into the port may damage the port. Make sure that the USB device is connected correctly into the USB port.**
- **Do not grab the USB port cover (if so equipped) when pulling the USB device out of the port. This could damage the port and the cover.**
- **Do not leave the USB cable in a place where it can be pulled unintentionally. Pulling the cable may damage the port.**

The vehicle is not equipped with a USB device. USB devices should be purchased separately as necessary.

This system cannot be used to format USB devices. To format a USB device, use a personal computer.

In some states/area, the USB device for the front seats plays only sound without images for regulatory reasons, even when the vehicle is parked.

This system supports various USB memory devices, USB hard drives and iPod® players. Some USB devices may not be supported by this system.

- Partitioned USB devices may not play correctly.
- Some characters used in other languages (Chinese, Japanese, etc.) may not appear properly in the display. Using English language characters with a USB device is recommended.

### General notes for USB use:

- Refer to your device manufacturer's owner information regarding the proper use and care of the device.

### Notes for iPod® use:

iPod® is a trademark of Apple Inc., registered in the U.S. and other countries.

- Improperly plugging in the iPod® may cause a checkmark to be displayed on and off (flickering). Always make sure that the iPod® is connected properly.
- An iPod® nano (1st Generation) may remain in fast forward or rewind mode if it is connected during a seek operation. In this case, please manually reset the iPod®.
- An iPod® nano (2nd Generation) will continue to fast-forward or rewind if it is disconnected during a seek operation.
- An incorrect song title may appear when the Play Mode is changed while using an iPod® nano (2nd Generation).
- Audiobooks may not play in the same order as they appear on an iPod®.
- Large video files cause slow responses in an iPod®. The vehicle center display may momentarily black out, but will soon recover.

- If an iPod® automatically selects large video files while in the shuffle mode, the vehicle center display may momentarily black out, but will soon recover.

## Bluetooth® streaming audio

- Some Bluetooth® audio devices may not be recognized by the in-vehicle audio system.
- It is necessary to set up the wireless connection between a compatible Bluetooth® audio device and the in-vehicle Bluetooth® module before using the Bluetooth® audio.
- Operating procedure of the Bluetooth® audio will vary depending on the devices. Make sure how to operate your audio device before using it with this system.
- The Bluetooth® audio may be stopped under the following conditions:
  - Receiving a call on the Hands-Free Phone System.
  - Checking the connection to the hands-free phone.
- Do not place the Bluetooth® audio device in an area surrounded by metal or far away from the in-vehicle Bluetooth® module to prevent tone quality degradation and wireless connection disruption.

- While an audio device is connected through the Bluetooth® wireless connection, the battery power of the device may discharge quicker than usual.
- This system supports the Bluetooth® Audio Distribution Profile (A2DP, AVRCP).



BLUETOOTH® is a trademark owned by Bluetooth SIG, Inc. and licensed to Visteon.

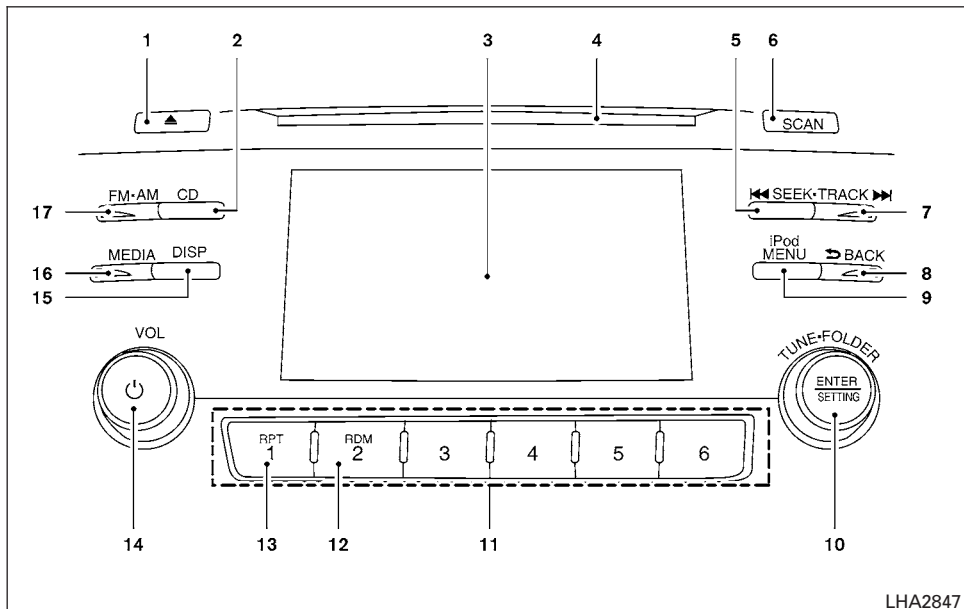

LHA2847

- 1. ▲ CD eject button
- 2. CD button
- 3. Display screen
- 4. CD insert slot
- 5. ◀◀ SEEK button
- 6. SCAN button

- 7. ▶▶ TRACK button
- 8. ↶ BACK button
- 9. iPod MENU button
- 10. TUNE/FOLDER knob, ENTER/SETTING button
- 11. Station select (1 - 6) buttons
- 12. RDM button
- 13. RPT button

- 14. VOL (volume) knob / ⏻ button
- 15. DISP button
- 16. MEDIA button
- 17. FM•AM button

### FM/AM RADIO WITH COMPACT DISC (CD) PLAYER (Type A) (if so equipped)

For all operation precautions, see "Audio operation precautions" in this section.

### Audio main operation

#### **VOL (volume) / ⏻ (power) button:**

Place the ignition switch in the ACC or ON position and press the ⏻ (power) button while the system is off to call up the mode (radio, CD, AUX, Bluetooth® audio USB or iPod®) that was playing immediately before the system was turned off.

To turn the system off, press the ⏻ (power) button.

Turn the VOL (volume) control knob to adjust the volume.

This vehicle may be equipped with Speed Sensitive Volume. When this feature is active, the audio volume changes as the driving speed changes.

### SETTING button:

Press the SETTING button to show the Settings screen on the display. Turn the TUNE/FOLDER knob to navigate the options and then press the ENTER button to make a selection.

Audio		
	Bass	Adjusts the bass to the desired level.
	Treble	Adjusts the treble to the desired level.
	Balance	Adjusts the balance to the desired level. Balance adjusts the sound level between the left and right speakers.
	Fade	Adjusts the fade to the desired level. Fade adjusts the sound level between the front and rear speakers.
	Speed Sens Vol. (Speed Sensitive Volume)	Adjusts the speed sensitive volume function, which increases the volume of the audio system as the speed of the vehicle increases. Set to "OFF" to disable the feature. The higher the setting, the more the volume increases in relation to vehicle speed.
	AUX Vol.	Choose a setting from 0 to +3 to control the boost of incoming auxiliary device volume. A setting of 0 provides no additional boost in volume. A setting of +3 provides the greatest boost in volume.
	Brightness and Contrast	Adjust the brightness or contrast to adjust the appearance of the display screen.
	Clock adjust	Press the ENTER/SETTING button to highlight the hours or minutes and then use the TUNE/FOLDER knob to adjust the value. Press the ENTER/SETTING button again to set the value.
	On-Screen Clock	Toggles ON or OFF the clock display on the upper right corner of the display screen.
	RDS Display	Toggles ON or OFF the RDS information displayed on the screen while the radio is playing.
	Language	Select the desired language for the system from the available options.

Bass, treble, balance and fade can also be adjusted by pressing the ENTER/SETTING button and turning the TUNE/FOLDER knob to select the item to adjust. When the desired item is shown on the display, turn the tuning to adjust and then press the ENTER/SETTING button until the display returns to the main audio screen. If the button is not pressed for approximately 10 seconds, the radio or CD display will automatically reappear.



## iPod® MENU button

This button can only be used for iPod® operations. See “iPod® player operation without Navigation System” later in this section for details about the function of this button.

## FM/AM radio operation

### FM-AM button:

Press the FM-AM button to change the band as follows:

AM → FM1 → FM2 → AM



If another audio source is playing when the FM-AM button is pressed, the audio source playing will automatically be turned off and the last radio station played will begin playing.

The FM stereo indicator (STEREO) is shown on the screen during FM stereo reception. When the stereo broadcast signal is weak, the radio automatically changes from stereo to monaural reception.

### TUNE/FOLDER knob (Tuning):

Turn the TUNE/FOLDER knob to the left or right for manual tuning.



Press the SEEK button  or  to tune from low to high or high to low frequencies and to stop at the next broadcasting station.



### SCAN tuning:

Press the SCAN button to stop at each broadcasting station for 5 seconds. SCAN will appear on the screen while the radio is scan tuning.

Pressing the button again during this 5 second period will stop SCAN tuning and the radio will remain tuned to that station. If the SCAN button is not pressed within 5 seconds, SCAN tuning moves to the next station.

### 1 to 6 Station memory operations:

Six stations can be set for the AM band. Twelve stations can be set for the FM band (6 for FM1, 6 for FM2).

1. Choose the radio band AM, FM1 or FM2 using the FM-AM select button.
2. Tune to the desired station using the SEEK  button or the TRACK  button. Press and hold any of the desired station memory buttons (1 – 6) until the preset number is updated on the display and the sound is briefly muted.

3. The channel indicator will then come on and the sound will resume. Programming is now complete.
4. Other buttons can be set in the same manner.

If the battery cable is disconnected, or if the fuse opens, the radio memory will be canceled. In that case, reset the desired stations.

## Compact disc (CD) player operation

If the radio is already operating, it automatically turns off and the compact disc begins to play.

### MEDIA button:

With a CD loaded, press the MEDIA button until the CD mode is displayed on the screen.



### CD/MP3 display mode:

While listening to an MP3/WMA CD, certain text may be displayed on the screen if the CD has been encoded with text information. Depending on how the MP3/WMA CD is encoded, information such as Artist, Song and Folder will be displayed.

The track number and the total number of tracks in the current folder or on the current disc are displayed on the screen as well.







### **SEEK/TRACK (Reverse or Fast Forward) button:**

Press and hold the SEEK/TRACK button  or  for 1.5 seconds while the compact disc is playing to reverse or fast forward the track being played. The compact disc plays at an increased speed while reversing or fast forwarding. When the button is released, the compact disc returns to normal play speed.



### **SEEK/TRACK button:**

Press the SEEK/TRACK button  while a CD or MP3/WMA CD is playing to return to the beginning of the current track. Press the SEEK/TRACK button  several times to skip backward several tracks.

Press the SEEK/TRACK button  while a CD or MP3/WMA CD is playing to advance one track. Press the SEEK/TRACK button  several times to skip forward several tracks. If the last track on a CD is skipped, the first track on the disc is played. If the last track in a folder of an MP3/WMA CD is skipped, the first track of the next folder is played.

### **TUNE/FOLDER knob (MP3/WMA CD only):**

If an MP3/WMA CD with multiple folders is playing, turn the TUNE/FOLDER knob to change folders. Turn the knob to the left to skip back a folder. Turn the knob to the right to skip ahead a folder.

### **RPT button:**

When the RPT button is pressed while a compact disc is playing, the play pattern can be changed as follows:

CD:

1 Track Repeat  $\longleftrightarrow$  OFF

CD with MP3 or WMA:

1 Folder Repeat  $\rightarrow$  1 Track Repeat  $\rightarrow$  OFF

1 Track Repeat: the current track will be repeated.

1 Folder Repeat: the current folder will be repeated.

OFF: No repeat play pattern is applied. The indicator on the display will turn off.

The current play pattern of the CD is displayed on the screen unless no pattern is applied.

### **RDM button:**

When the RDM button is pressed while a compact disc is playing, the play pattern can be changed as follows:

CD:

1 Disc Random  $\longleftrightarrow$  OFF

CD with MP3 or WMA:

1 Disc Random  $\rightarrow$  1 Folder Random  $\rightarrow$  OFF

1 Disc Random: all tracks on the disc will be played randomly.

1 Folder Random: all tracks in the current folder will be played randomly.

OFF: No random play pattern is applied. The indicator on the display will turn off.

The current play pattern of the CD is displayed on the screen unless no pattern is applied.



### **EJECT button:**

When the  button is pressed with a compact disc loaded, the compact disc will eject and the last source will be played.

When the  button is pressed twice with a compact disc loaded, the compact disc will be ejected further for easier CD removal. If the disc is not removed within 20 seconds, the disc will reload.

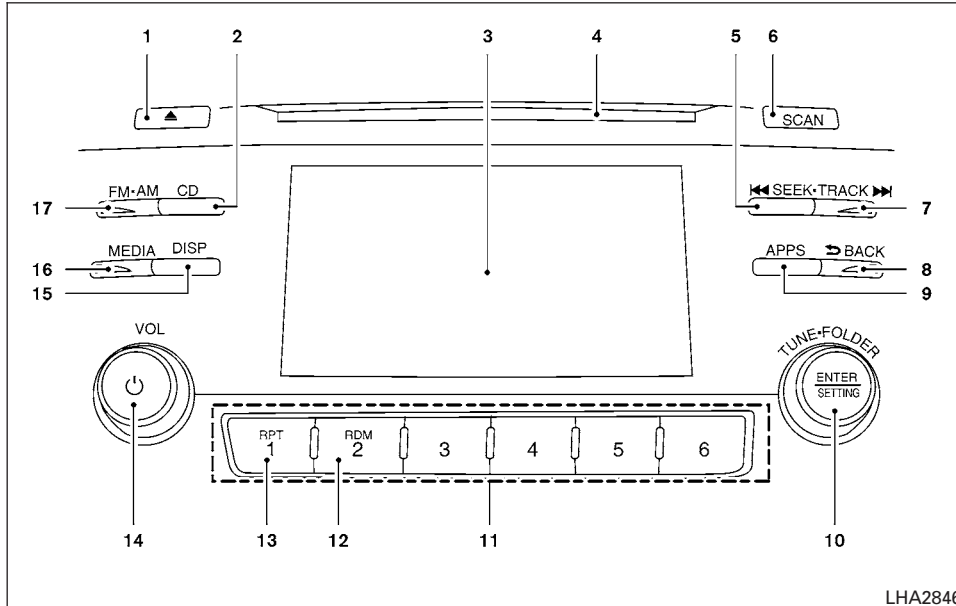

LHA2846

- |                      |  |
|----------------------|--|
| 1. ▲ CD eject button | 7. ►► TRACK button                         |
| 2. CD button         | 8. ↶ BACK button                           |
| 3. Display screen    | 9. APPS button                             |
| 4. CD insert slot    | 10. TUNE/FOLDER knob, ENTER/SETTING button |
| 5. ◀◀ SEEK button    |  |
| 6. SCAN button       |  |

- 11. Station select (1 - 6) buttons
- 12. RDM button
- 13. RPT button
- 14. VOL (volume) knob / ⏻ button
- 15. DISP button
- 16. MEDIA button
- 17. FM•AM button

### FM/AM RADIO WITH COMPACT DISC (CD) PLAYER (Type B) (if so equipped)

For all operation precautions, see "Audio operation precautions" in this section.

#### Audio main operation

#### **VOL (volume) / ⏻ (power) button:**

Place the ignition switch in the ACC or ON position and press the ⏻ (power) button while the system is off to call up the mode (radio, CD, AUX, Bluetooth® audio USB or iPod®) that was playing immediately before the system was turned off.

To turn the system off, press the ⏻ (power) button.

Turn the VOL (volume) control knob to adjust the volume.

This vehicle may be equipped with Speed Sensitive Volume. When this feature is active, the audio volume changes as the driving speed changes.

**ENTER/SETTING button:**

Press the ENTER/SETTING button to show the Settings screen on the display. Turn the TUNE/SCROLL knob to navigate the options and then press the ENTER button to make a selection.

Audio		
	Bass	Adjusts the bass to the desired level.
	Treble	Adjusts the treble to the desired level.
	Balance	Adjusts the balance to the desired level. Balance adjusts the sound level between the left and right speakers.
	Fade	Adjusts the fade to the desired level. Fade adjusts the sound level between the front and rear speakers.
	Speed Sens Vol. (Speed Sensitive Volume)	Adjusts the speed sensitive volume function, which increases the volume of the audio system as the speed of the vehicle increases. Set to "OFF" to disable the feature. The higher the setting, the more the volume increases in relation to vehicle speed.
	AUX Vol.	Choose a setting from 0 to +3 to control the boost of incoming auxiliary device volume. A setting of 0 provides no additional boost in volume. A setting of +3 provides the greatest boost in volume.
	Brightness and Contrast	Adjust the brightness or contrast to adjust the appearance of the display screen.
	Clock adjust	Press the ENTER/SETTING button to highlight the hours or minutes and then use the TUNE/SCROLL knob to adjust the value. Press the ENTER/SETTING button again to set the value.
	On-Screen Clock	Toggles ON or OFF the clock display on the upper right corner of the display screen.
	RDS Display	Toggles ON or OFF the RDS information displayed on the screen while the radio is playing.
	Language	Select the desired language for the system from the available options.

Bass, treble, balance and fade can also be adjusted by pressing the ENTER/SETTING button and turning the TUNE/SCROLL control knob to select the item to adjust. When the desired item is shown on the display, turn the tuning to adjust and then press the ENTER/SETTING button until the display returns to the main audio screen. If the button is not pressed for approximately 10 seconds, the radio or CD display will automatically reappear.

### **APPS button:**

Press the APPS button to launch the Smartphone Integration Mode. See “NissanConnect™ APP Smartphone Integration” in this section for more information about using this feature.

For more information on connecting your phone, see the “Bluetooth® Hands-Free Phone system without Navigation” section.

### **FM/AM radio operation**

#### **FM-AM button:**

Press the FM-AM button to change the band as follows:

AM → FM1 → FM2 → AM

If another audio source is playing when the FM-AM button is pressed, the audio source playing will automatically be turned off and the last radio station played will begin playing.

The FM stereo indicator (STEREO) is shown on the screen during FM stereo reception. When the stereo broadcast signal is weak, the radio automatically changes from stereo to monaural reception.

#### **TUNE/FOLDER knob (Tuning):**

Turn the TUNE/FOLDER knob to the left or right for manual tuning.



#### **SEEK tuning:**

Press the SEEK button  or  to tune from low to high or high to low frequencies and to stop at the next broadcasting station.



#### **SCAN tuning:**

Press the SCAN button to stop at each broadcasting station for 5 seconds. SCAN will appear on the screen while the radio is scan tuning.

Pressing the button again during this 5 second period will stop SCAN tuning and the radio will remain tuned to that station. If the SCAN button is not pressed within 5 seconds, SCAN tuning moves to the next station.

#### **1 to 6 Station memory operations:**

Six stations can be set for the AM band. Twelve stations can be set for the FM band (6 for FM1, 6 for FM2).

1. Choose the radio band AM, FM1 or FM2 using the FM-AM select button.
2. Tune to the desired station using the SEEK  button or the TRACK  button. Press and hold any of the desired station memory buttons (1 – 6) until the preset number is updated on the display and the sound is briefly muted.

3. The channel indicator will then come on and the sound will resume. Programming is now complete.
4. Other buttons can be set in the same manner.

If the battery cable is disconnected, or if the fuse opens, the radio memory will be canceled. In that case, reset the desired stations.

### **Compact disc (CD) player operation**

If the radio is already operating, it automatically turns off and the compact disc begins to play.

#### **MEDIA button:**

With a CD loaded, press the MEDIA button until the CD mode is displayed on the screen.



#### **CD/MP3 display mode:**

While listening to an MP3/WMA CD, certain text may be displayed on the screen if the CD has been encoded with text information. Depending on how the MP3/WMA CD is encoded, information such as Artist, Song and Folder will be displayed.

The track number and the total number of tracks in the current folder or on the current disc are displayed on the screen as well.







### **SEEK/TRACK (Reverse or Fast Forward) button:**

Press and hold the SEEK/TRACK button  or  for 1.5 seconds while the compact disc is playing to reverse or fast forward the track being played. The compact disc plays at an increased speed while reversing or fast forwarding. When the button is released, the compact disc returns to normal play speed.



### **SEEK/TRACK button:**

Press the SEEK/TRACK button  while a CD or MP3/WMA CD is playing to return to the beginning of the current track. Press the SEEK/TRACK button  several times to skip backward several tracks.

Press the SEEK/TRACK button  while a CD or MP3/WMA CD is playing to advance one track. Press the SEEK/TRACK button  several times to skip forward several tracks. If the last track on a CD is skipped, the first track on the disc is played. If the last track in a folder of an MP3/WMA CD is skipped, the first track of the next folder is played.

### **TUNE/FOLDER knob (MP3/WMA CD only):**

If an MP3/WMA CD with multiple folders is playing, turn the TUNE/FOLDER knob to change folders. Turn the knob to the left to skip back a folder. Turn the knob to the right to skip ahead a folder.

### **RPT button:**

When the RPT button is pressed while a compact disc is playing, the play pattern can be changed as follows:

CD:

1 Track Repeat  $\longleftrightarrow$  OFF

CD with MP3 or WMA:

1 Folder Repeat  $\rightarrow$  1 Track Repeat  $\rightarrow$  OFF

1 Track Repeat: the current track will be repeated.

1 Folder Repeat: the current folder will be repeated.

OFF: No repeat play pattern is applied. The indicator on the display will turn off.

The current play pattern of the CD is displayed on the screen unless no pattern is applied.

### **RDM button:**

When the RDM button is pressed while a compact disc is playing, the play pattern can be changed as follows:

CD:

1 Disc Random  $\longleftrightarrow$  OFF

CD with MP3 or WMA:

1 Disc Random  $\rightarrow$  1 Folder Random  $\rightarrow$  OFF

1 Disc Random: all tracks on the disc will be played randomly.

1 Folder Random: all tracks in the current folder will be played randomly.

OFF: No random play pattern is applied. The indicator on the display will turn off.

The current play pattern of the CD is displayed on the screen unless no pattern is applied.



### **EJECT button:**

When the  button is pressed with a compact disc loaded, the compact disc will eject and the last source will be played.

When the  button is pressed twice with a compact disc loaded, the compact disc will be ejected further for easier CD removal. If the disc is not removed within 20 seconds, the disc will reload.

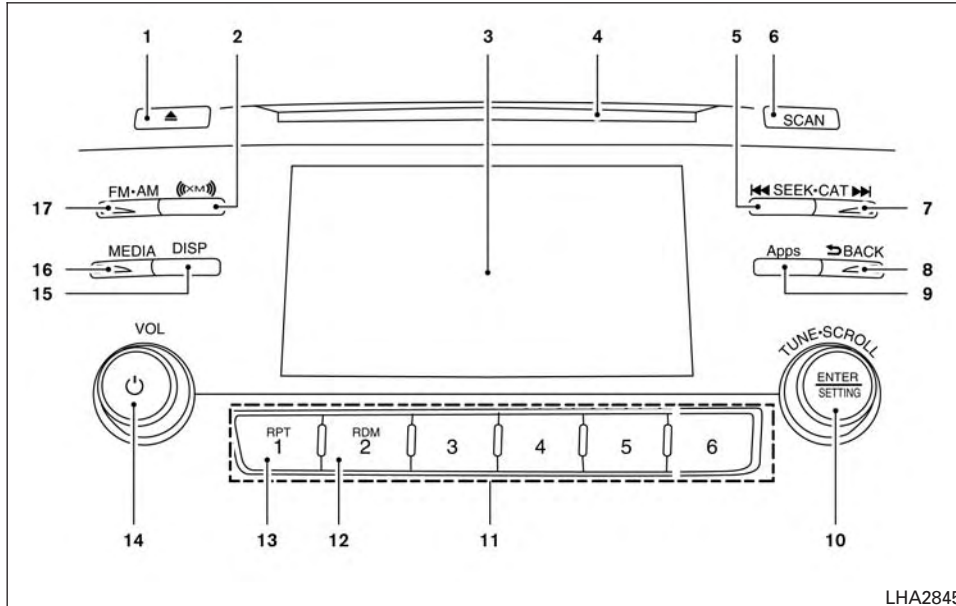

1. ▲ CD eject button
2. XM button\*
3. Display screen
4. CD insert slot
5. ◀◀ SEEK button
6. SCAN button

7. ▶▶ CAT button
8. ↶ BACK button
9. APPS button
10. TUNE/SCROLL knob, ENTER/SETTING button
11. Station select (1 - 6) buttons
12. RDM button
13. RPT button

14. VOL (volume) knob / ⏻ button
15. DISP button
16. MEDIA button
17. FM•AM button

\*No satellite radio reception is available when the XM button is pressed to access satellite radio stations unless optional satellite receiver and antenna are installed and an SiriusXM® Satellite Radio service subscription is active. Satellite radio is not available in Alaska, Hawaii and Guam.

### FM/AM/SAT RADIO WITH COMPACT DISC (CD) PLAYER (Type A) (if so equipped)

For all operation precautions, see “Audio operation precautions” in this section.

#### Audio main operation

##### **VOL (volume) / ⏻ (power) button:**

Place the ignition switch in the ACC or ON position and press the ⏻ (power) button while the system is off to call up the mode (radio, CD, AUX, Bluetooth® audio USB or iPod®) that was playing immediately before the system was turned off.

To turn the system off, press the  (power) button.

Turn the VOL (volume) control knob to adjust the volume.

This vehicle may be equipped with Speed Sensitive Volume. When this feature is active, the audio volume changes as the driving speed changes.

#### **ENTER/SETTING button:**

Press the ENTER/SETTING button to show the Settings screen on the display. Turn the TUNE/SCROLL knob to navigate the options and then press the ENTER button to make a selection.

Audio	
Bass	Adjusts the bass to the desired level.
Treble	Adjusts the treble to the desired level.
Balance	Adjusts the balance to the desired level. Balance adjusts the sound level between the left and right speakers.
Fade	Adjusts the fade to the desired level. Fade adjusts the sound level between the front and rear speakers.
Speed Sens Vol. (Speed Sensitive Volume)	Adjusts the speed sensitive volume function, which increases the volume of the audio system as the speed of the vehicle increases. Set to "OFF" to disable the feature. The higher the setting, the more the volume increases in relation to vehicle speed.
AUX Vol.	Choose a setting from 0 to +3 to control the boost of incoming auxiliary device volume. A setting of 0 provides no additional boost in volume. A setting of +3 provides the greatest boost in volume.
Brightness and Contrast	Adjust the brightness or contrast to adjust the appearance of the display screen.
Clock adjust	Press the ENTER/SETTING button to highlight the hours or minutes and then use the TUNE/SCROLL knob to adjust the value. Press the ENTER/SETTING button again to set the value.
On-Screen Clock	Toggles ON or OFF the clock display on the upper right corner of the display screen.
RDS Display	Toggles ON or OFF the RDS information displayed on the screen while the radio is playing.
Language	Select the desired language for the system from the available options.

Bass, treble, balance and fade can also be adjusted by pressing the ENTER/SETTING button and turning the TUNE/SCROLL control knob to select the item to adjust. When the desired item is shown on the display, turn the tuning to adjust and then press the ENTER/SETTING button until the display returns to the main audio screen. If the button is not pressed for approximately 10 seconds, the radio or CD display will automatically reappear.



### **APPS button:**

Press the APPS button to launch the Smartphone Integration Mode. See “NissanConnect™ APP Smartphone Integration” in this section for more information about using this feature.

For more information on connecting your phone, see the “Bluetooth® Hands-Free Phone system without Navigation” section.

### **FM/AM/SAT radio operation**

#### **FM-AM button:**

Press the FM-AM button to change the band as follows:

AM → FM1 → FM2 → AM

If another audio source is playing when the FM-AM button is pressed, the audio source playing will automatically be turned off and the last radio station played will begin playing.

The FM stereo indicator (STEREO) is shown on the screen during FM stereo reception. When the stereo broadcast signal is weak, the radio automatically changes from stereo to monaural reception.

#### **XM band select:**

Press the XM button to change the band as follows:

XM1\* → XM2\* → XM3\* → XM1 (satellite, if so equipped)

When the XM button is pressed while the ignition switch is in the ACC or ON position, the radio will come on at the station last played.

The last station played will also come on when the VOL (volume)/  (power) control knob/button is pressed on.

\*When the XM button is pressed, the satellite radio reception will not be available unless an optional satellite receiver and antenna are installed and a SiriusXM® Satellite Radio service subscription is active. Satellite radio is not available in Alaska, Hawaii and Guam.

If a compact disc is playing when the XM button is pressed, the compact disc will automatically be turned off and the last radio station played will come on.

#### **TUNE/SCROLL knob (Tuning):**

Turn the TUNE/SCROLL knob to the left or right for manual tuning.



Press the SEEK button  or  to tune from low to high or high to low frequencies and to stop at the next broadcasting station.

#### **SCAN tuning:**

Press the SCAN button to stop at each broadcasting station for 5 seconds. SCAN will appear on the screen while the radio is scan tuning.

Pressing the button again during this 5 second period will stop SCAN tuning and the radio will remain tuned to that station. If the SCAN button is not pressed within 5 seconds, SCAN tuning moves to the next station.

#### **1 to 6 Station memory operations:**

Six stations can be set for the AM band. Twelve stations can be set for the FM band (6 for FM1, 6 for FM2). Eighteen channels can be set for the satellite radio (6 for XM1, 6 for XM2, 6 for XM3).

1. Choose the radio band AM, FM1 or FM2 using the FM-AM select button, or choose the satellite band XM1, XM2 or XM3 using the XM button.

2. Tune to the desired station using manual, SEEK or SCAN tuning. Press and hold any of the desired station memory buttons (1 – 6) until the preset number is updated on the display and the sound is briefly muted.
3. The channel indicator will then come on and the sound will resume. Programming is now complete.
4. Other buttons can be set in the same manner.

If the battery cable is disconnected, or if the fuse opens, the radio memory will be canceled. In that case, reset the desired stations.

### Compact disc (CD) player operation

If the radio is already operating, it automatically turns off and the compact disc begins to play.

#### **MEDIA button:**

With a CD loaded, press the MEDIA button until the CD mode is displayed on the screen.



#### **CD/MP3 display mode:**

While listening to an MP3/WMA CD, certain text may be displayed on the screen if the CD has been encoded with text information. Depending on how the MP3/WMA CD is encoded, information such as Artist, Song and Folder will be displayed.

The track number and the total number of tracks in the current folder or on the current disc are displayed on the screen as well.







**SEEK/CAT (Reverse or Fast Forward) button:**

Press and hold the SEEK/CAT button  or  for 1.5 seconds while the compact disc is playing to reverse or fast forward the track being played. The compact disc plays at an increased speed while reversing or fast forwarding. When the button is released, the compact disc returns to normal play speed.



**SEEK/CAT button:**

Press the SEEK/CAT button  while a CD or MP3/WMA CD is playing to return to the beginning of the current track. Press the SEEK/CAT button  several times to skip backward several tracks.

Press the SEEK/CAT button  while a CD or MP3/WMA CD is playing to advance one track. Press the SEEK/CAT button  several times to skip forward several tracks. If the last track on a CD is skipped, the first track on the disc is played. If the last track in a folder of an MP3/WMA CD is skipped, the first track of the next folder is played.

#### **TUNE/SCROLL knob (MP3/WMA CD only):**

If a MP3/WMA CD with multiple folders is playing, turn the TUNE/SCROLL knob to change folders. Turn the knob to the left to skip back a folder. Turn the knob to the right to skip ahead a folder.

#### **RPT button:**

When the RPT button is pressed while a compact disc is playing, the play pattern can be changed as follows:

CD:

1 Track Repeat  OFF

CD with MP3 or WMA:

1 Folder Repeat  1 Track Repeat  OFF

1 Track Repeat: the current track will be repeated.

1 Folder Repeat: the current folder will be repeated.

OFF: No repeat play pattern is applied. The indicator on the display will turn off.

The current play pattern of the CD is displayed on the screen unless no pattern is applied.

### **RDM button:**

When the RDM button is pressed while a compact disc is playing, the play pattern can be changed as follows:

CD:

1 Disc Random  $\longleftrightarrow$  OFF

CD with MP3 or WMA:

1 Disc Random  $\rightarrow$  1 Folder Random  $\rightarrow$  OFF

1 Disc Random: all tracks on the disc will be played randomly.

1 Folder Random: all tracks in the current folder will be played randomly.

OFF: No random play pattern is applied. The indicator on the display will turn off.

The current play pattern of the CD is displayed on the screen unless no pattern is applied.



### **EJECT button:**

When the  button is pressed with a compact disc loaded, the compact disc will eject and the last source will be played.

When the  button is pressed twice with a compact disc loaded, the compact disc will be ejected further for easier CD removal. If the disc is not removed within 20 seconds, the disc will reload.

### **Additional features**

For more information about the iPod® player available with this system, see “iPod® player operation without Navigation System” in this section.

For more information about the USB interface available with this system, see “USB interface (models without Navigation System)” in this section.

For more information about the Bluetooth® audio interface available with this system, see “Bluetooth® streaming audio without Navigation System (Type B)” in this section.

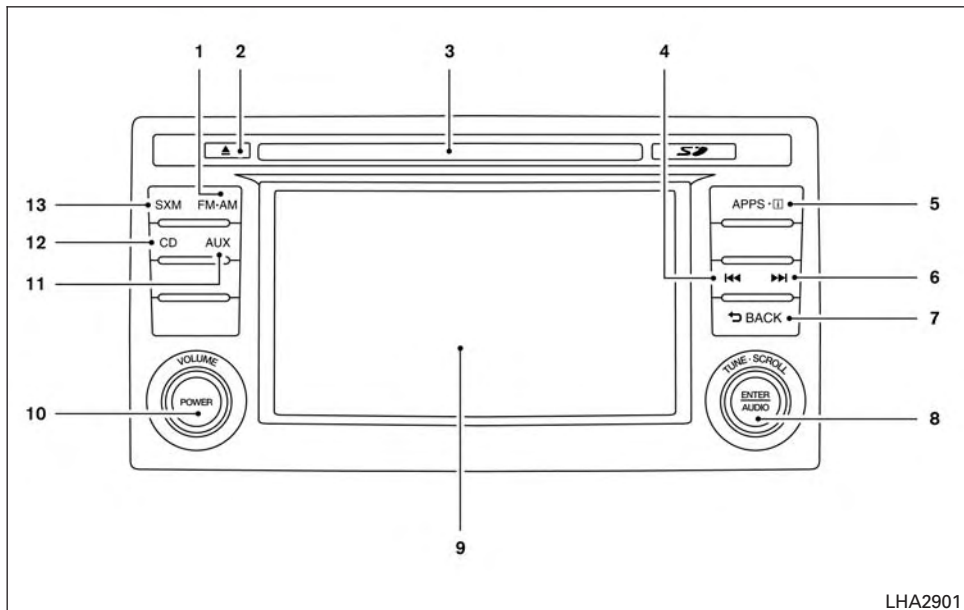

1. FM-AM button
2. ▲ CD eject button
3. CD insert slot
4. ◀◀ Backward seek button
5. APPS [ ] button

6. ▶▶ Forward seek button
7. ↶ BACK button
8. TUNE/SCROLL knob, ENTER/AUDIO button
9. Display screen

10. POWER button/ VOLUME control knob
11. AUX button
12. CD button
13. SXM button

The [ APPS [ ] ] button launches the Smartphone Integration Mode. See “Nissan-Connect™ APP Smartphone Integration” in this section for more information.

\*No satellite radio reception is available when the SXM button is pressed to access satellite radio stations unless optional satellite receiver and antenna are installed and an SiriusXM® Satellite Radio service subscription is active. Satellite radio is not available in Alaska, Hawaii and Guam.

## FM/AM/SAT RADIO WITH COMPACT DISC (CD) PLAYER (Type B) (if so equipped)

For all operation precautions, see “Audio operation precautions” in this section.

### Audio main operation

#### POWER button/ VOLUME control knob:

Place the ignition switch in the ACC or ON position, and then push the POWER button/ VOLUME control knob while the system is off to call up the mode (radio or CD) which was playing immediately before the system was turned off.

To turn the system off, press the POWER button/ VOLUME control knob.

Turn the POWER button/VOLUME control knob to adjust the volume.

This vehicle may be equipped with Speed Sensitive Volume (SSV) for audio. The audio volume changes as the driving speed changes.

#### Audio settings:

1. Press the [ APPS ] button.
2. Touch the “Settings” key.
3. Touch the “Audio” key.

Use the touchscreen to adjust the following items to the desired setting:

Audio		
	Bass	Adjusts the bass to the desired level.
	Treble	Adjusts the treble to the desired level.
	Balance	Adjusts the balance to the desired level. Balance adjusts the sound level between the left and right speakers.
	Fade	Adjusts the fade to the desired level. Fade adjusts the sound level between the front and rear speakers.
	Speed Sensitive Vol.	Adjusts the speed sensitive volume function, which increases the volume of the audio system as the speed of the vehicle increases. Set to “OFF” to disable the feature. The higher the setting, the more the volume increases in relation to vehicle speed.
	AUX Volume Level/AUX Level	Controls the volume level of incoming sound when an auxiliary device is connected to the system. Available options are Low (Quiet), Medium, and High (Loud).

Bass, treble, balance and fade can also be adjusted by pressing the AUDIO control knob and turning it to select the item to adjust. When the desired item is shown on the display, turn the tuning to adjust and then press the AUDIO button until the display returns to the main audio screen. If the button is not pressed for approximately 10 seconds, the radio or CD display will automatically reappear.

### **SXM settings:**

To view the SXM settings:

1. Press the [APPS] button.
2. Touch the “Settings” key.
3. Touch the “SXM” key.

The signal strength, activation status and other information are displayed on the screen.

### **FM/AM/SAT radio operation**

#### **FM-AM button:**

Press the FM-AM button to change the band as follows:

AM → FM1 → FM2 → AM

If another audio source is playing when the FM-AM button is pressed, the audio source playing will automatically be turned off and the last radio station played will begin playing.

The FM stereo indicator (ST) is shown on the screen during FM stereo reception. When the stereo broadcast signal is weak, the radio automatically changes from stereo to monaural reception.

### **SXM band select:**

Pressing the SXM button will change the band as follows:

SXM1\* → SXM2\* → SXM3\* → SXM1\* (satellite, if so equipped)

When the SXM button is pressed while the ignition switch is in the ACC or ON position, the radio will come on at the last station played.

The last station played will also come on when the POWER/VOLUME button/control knob is pressed.

\*When the SXM button is pressed, the satellite radio mode will be skipped unless an optional satellite receiver and antenna are installed and a SiriusXM® Satellite Radio service subscription is active. Satellite radio is not available in Alaska, Hawaii and Guam.

If a compact disc is playing when the SXM button is pressed, the compact disc will automatically be turned off and the last radio station played will come on.

While the radio is in SXM mode, the operation can be controlled through the touchscreen. Touch the “Channels” key to display a list of channels. Touch a channel displayed on the list to change to that channel. Touch the “Categories” key to display a list of categories. Touch a category displayed on the list to display options within that category.



### **Tuning with the touchscreen:**



When in AM or FM mode, the radio can be tuned using the touchscreen. To bring up the visual tuner, touch the “Tune” key on the lower right corner of the screen. A screen appears with a bar running from low frequencies on the left to high frequencies on the right. Touch the screen at the location of the frequency you wish to tune and the station will change to that frequency. To return to the regular radio display screen, touch the “OK” key.

### **Tuning with the TUNE/SCROLL knob:**

The radio can also be manually tuned using the TUNE/SCROLL knob. When in FM or AM mode, turn the TUNE/SCROLL knob to the left for lower frequencies or to the right for higher frequencies. When in SXM mode, turn the TUNE/SCROLL knob to change the channel.



When in FM or AM mode, press the seek buttons  or  to tune from low to high or high to low frequencies and to stop at the next broadcasting station.

When in SXM mode, press the seek buttons  or  to change the category.

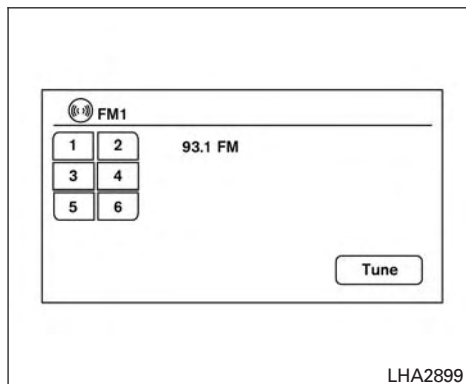

#### 1 to 6 Station memory operations:

Twelve stations can be set for the FM band (6 for FM1, 6 for FM2) and six stations can be set for the AM band. Eighteen stations can be set for the SXM band (6 for SXM1, 6 for SXM2, 6 for SXM3).

1. Choose the radio band AM, FM1 or FM2 using the FM·AM select button or choose the radio band SXM1, SXM2, SXM3 using the SXM button.
2. Tune to the desired station using manual or seek tuning. Touch and hold any of the desired station memory keys (1 – 6) until a beep sound is heard.

3. The channel indicator will then come on and the sound will resume. Programming is now complete.
4. Other keys can be set in the same manner.

If the battery cable is disconnected or if the fuse opens, the radio memory will be canceled. In that case, reset the desired stations.

Presets can also be selected by touching the desired preset number on the screen.

#### Compact disc (CD) player operation

If the radio is already operating, it automatically turns off and the compact disc begins to play.

#### CD button:

When the CD button is pressed with the system off and the compact disc loaded, the system will turn on and the compact disc will start to play.



When the CD button is pressed with a compact disc loaded and the radio playing, the radio will automatically be turned off and the compact disc will start to play.

## CD/MP3 display mode:



Menu item		
CD/MP3		While listening to a CD or an MP3/WMA CD, certain text may be displayed (when a CD encoded with text is being used). Depending on how the CD or MP3/WMA CD is encoded, the text is displayed listing the artist, album and song title. There are other keys displayed on the screen when a CD is playing:
	Random	Touch the "Random" key to apply a random play pattern to the CD. If an MP3 CD is playing, touching "Random" or alternates between Random Folder, and Random All. This text will appear on the display. To cancel Random mode, touch the "Random" key until the key is no longer highlighted.
	Repeat	Touch the "Repeat" key to apply a repeat play pattern to the CD. If an MP3 CD is playing, touching "Repeat" alternates between repeating the current song and repeating the current folder. This text will appear on the display. To cancel Repeat mode, touch the "Repeat" key until the key is no longer highlighted
	Browse	Touch the "Browse" key to display the titles on the CD in list format. Touch the title of a song in the list to begin playing that song. If an MP3 CD is playing, touching the "Browse" key will also list the folders on the disc. Follow the procedure for selecting a song with the touchscreen to choose a folder.







Press and hold the seek buttons  or  for 1.5 seconds while the compact disc is playing to reverse or fast forward the track being played. The compact disc plays at an increased speed while reversing or fast forwarding. When the button is released, the compact disc returns to normal play speed.



Press the seek button  while a CD or MP3/WMA CD is playing to return to the beginning of the current track. Press the seek button  several times to skip backward several tracks.

Press the seek button  while a CD or MP3/WMA CD is playing to advance one track. Press the seek button  several times to skip forward several tracks. If the last track on a CD is skipped, the first track on the disc is played. If the last track in a folder of an MP3/WMA CD is skipped, the first track of the next folder is played.

#### **AUX button:**

The AUX IN audio input jack accepts any standard analog audio input such as from a portable cassette tape/CD player, MP3 player or a laptop computer. Press the AUX button to play a compatible device plugged into the AUX IN jack.



When the  button is pressed with a compact disc loaded, the compact disc will eject and the last source will be played.

If the disc is not removed within 10 seconds, the disc will reload.

#### **Additional features**

For more information about the iPod® player available with this system, see “iPod® player operation with Navigation System” in this section.

For more information about the USB interface available with this system, see “USB interface (models with Navigation System)” in this section.

For more information about the Bluetooth® audio interface available with this system, see “Bluetooth® streaming audio with Navigation System” in this section.

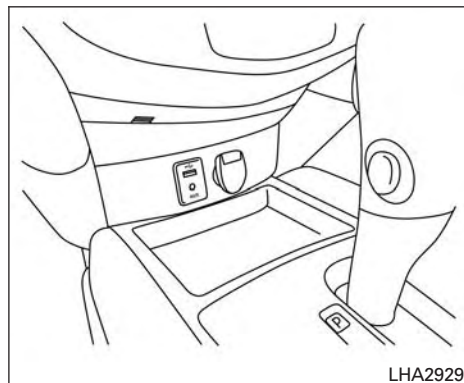

**USB INTERFACE** (models without Navigation System) (if so equipped)

Connecting a device to the USB input jack

#### **⚠ WARNING**

**Do not connect, disconnect, or operate the USB device while driving. Doing so can be a distraction. If distracted you could lose control of your vehicle and cause an accident or serious injury.**

## CAUTION

- To avoid damage and loss of function when using a USB device, note the following precautions.
- Do not force the USB device into the USB port. Inserting the USB device tilted or up-side-down into the port may damage the port. Make sure that the USB device is connected correctly into the USB port.
- Do not grab the USB port cover (if so equipped) when pulling the USB device out of the port. This could damage the port and the cover.
- Do not leave the USB cable in a place where it can be pulled unintentionally. Pulling the cable may damage the port.

Refer to your device manufacturer's owner information regarding the proper use and care of the device.

The USB input jack is located on the center console beneath the heater and air conditioner controls. Insert the USB device into the jack.

When a compatible storage device is plugged into the jack, compatible audio files on the storage device can be played through the vehicle's audio system.

## Audio file operation

### MEDIA button:

Place the ignition switch in the ON or ACC position and press the MEDIA button to switch to the USB input mode. If a CD is playing or another audio source is plugged in through the AUX IN jack located in the center console, the MEDIA button toggles between the three sources.



### Play information:

Information about the audio files being played can be displayed on the display screen of the vehicle's audio system. Depending on how the audio files are encoded, information such as Folder, Song and Artist will be displayed.

The track number and number of total tracks in the folder are displayed on the screen as well.





### SEEK•CAT/TRACK (Reverse or Fast Forward) button:

Press and hold the SEEK•CAT/TRACK button  (rewind) or SEEK•CAT/TRACK button  (fast forward) for 1.5 seconds while an audio file on the USB device is playing to reverse or fast forward the track being played. The track plays at an increased speed while

reversing or fast forwarding. When the button is released, the audio file returns to normal play speed.



### SEEK/CAT and TRACK buttons:

Press the SEEK/CAT button  while an audio file on the USB device is playing to return to the beginning of the current track. Press the SEEK/CAT button  several times to skip backward several tracks.

Press the TRACK button  while an audio file on the USB device is playing to advance one track. Press the TRACK button  several times to skip forward several tracks. If the last track in a folder on the USB device is skipped, the first track of the next folder is played.

### RDM button:

When the RDM button is pressed while an audio file on the USB device is playing, the play pattern can be changed as follows:

All Random → 1 Folder Random → OFF

All Random: all tracks on the USB device will be played randomly.

1 Folder Random: all tracks in the current folder will be played randomly.

**OFF:** No random play pattern is applied. The indicator on the display will turn off.

The current play pattern of the USB device is displayed on the screen unless no pattern is applied.

#### **RPT button:**

When the RPT button is pressed while an audio file on the USB device is playing, the play pattern can be changed as follows:

1 Folder Repeat → 1 Track Repeat → OFF

1 Track Repeat: the current track will be repeated.

1 Folder Repeat: the current folder will be repeated.

**OFF:** No repeat play pattern is applied. The indicator on the display will turn off.

The current play pattern of the USB device is displayed on the screen unless no pattern is applied.

#### **TUNE/SCROLL knob:**

If there are multiple folders with audio files on the USB device, turn the TUNE/SCROLL knob to change folders. Turn the knob to the left to skip back a folder. Turn the knob to the right to skip ahead a folder. If there is only one folder of audio files on the USB device, turning the TUNE/SCROLL knob in either direction will return to the first track on the USB device.

#### **TUNE/FOLDER knob:**

If there are multiple folders with audio files on the USB device, turn the TUNE/FOLDER knob to change folders. Turn the knob to the left to skip back a folder. Turn the knob to the right to skip ahead a folder. If there is only one folder of audio files on the USB device, turning the TUNE/FOLDER knob in either direction will return to the first track on the USB device.

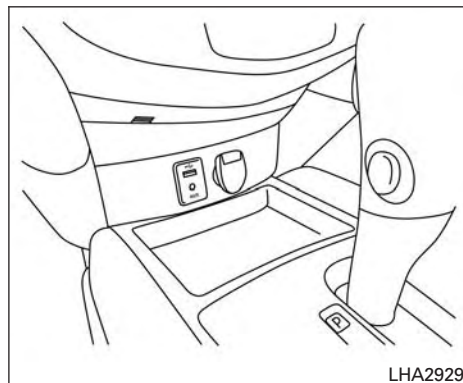

USB INTERFACE (models with Navigation System) (if so equipped)

Connecting a device to the USB input jack

#### **⚠ WARNING**

**Do not connect, disconnect, or operate the USB device while driving. Doing so can be a distraction. If distracted you could lose control of your vehicle and cause an accident or serious injury.**

## CAUTION

- To avoid damage and loss of function when using a USB device, note the following precautions.
- Do not force the USB device into the USB port. Inserting the USB device tilted or up-side-down into the port may damage the port. Make sure that the USB device is connected correctly into the USB port.
- Do not grab the USB port cover (if so equipped) when pulling the USB device out of the port. This could damage the port and the cover.
- Do not leave the USB cable in a place where it can be pulled unintentionally. Pulling the cable may damage the port.

Refer to your device manufacturer's owner information regarding the proper use and care of the device.

The USB input jack is located on the center console beneath the heater and air conditioner controls. Insert the USB device into the jack.

When a compatible storage device is plugged into the jack, compatible audio files on the storage device can be played through the vehicle's audio system.

## Audio file operation

### AUX button:

Place the ignition switch in the ON or ACC position and press the AUX button to switch to the USB input mode. If another audio source is playing and a USB memory device is inserted, press the AUX button until the center display changes to the USB memory mode.

If the system has been turned off while the USB memory was playing, push the POWER/VOLUME button/control knob to restart the USB memory.

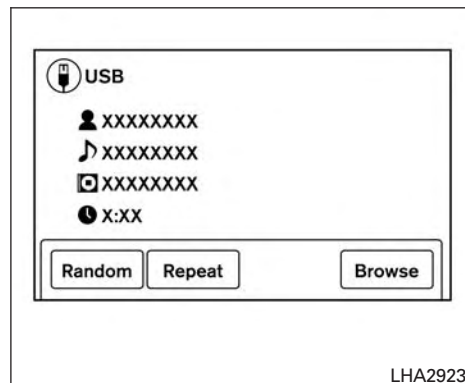



### Play information:

Information about the audio files being played is shown on the display screen of the vehicle's audio system. Touch "Browse" to display the list of folders and files on the USB device. Touch the name of a song on the screen to begin playing that song.



### Seeking buttons:

Press the  button while an audio file on the USB device is playing to return to the beginning of the current track. Press the  button several times to skip backward several tracks.

Press the **▶▶** button while an audio file on the USB device is playing to advance one track. Press the **▶▶** button several times to skip forward several tracks. If the last track in a folder on the USB device is skipped, the first track of the next folder is played.

### Random and repeat play mode:

While files on a USB device are playing, the play pattern can be altered so that songs are repeated or played randomly.

#### Random:

Touch the "Random" key to apply a random play pattern to the USB device. When the Random mode is active, the icon will illuminate. By touching the "Random" key again, the "Random Folder" key appears. By touching the "Random" key once more, the "Random All" key appears. To cancel Random mode, touch the "Random" key until no icons are illuminated.

#### Repeat:

Touch the "Repeat" key to apply a repeat play pattern to the USB device. When the Repeat mode is active, the icon will illuminate. By touching the "Repeat" key again, the "Repeat Track" key appears. By touching the "Repeat" key once more, the "Repeat Folder" key appears. To cancel Repeat mode, touch the "Repeat" key until no icons are illuminated.

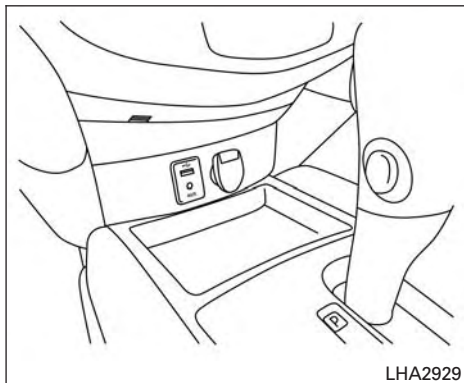

### iPod®\* PLAYER OPERATION WITHOUT NAVIGATION SYSTEM (if so equipped)

#### Connecting iPod®

#### **⚠ WARNING**

**Do not connect, disconnect, or operate the USB device while driving. Doing so can be a distraction. If distracted you could lose control of your vehicle and cause an accident or serious injury.**

#### **⚠ CAUTION**

- **Do not force the USB device into the USB port. Inserting the USB device tilted or up-side-down into the port may damage the port. Make sure that the USB device is connected correctly into the USB port.**
- **Do not grab the USB port cover (if so equipped) when pulling the USB device out of the port. This could damage the port and the cover.**
- **Do not leave the USB cable in a place where it can be pulled unintentionally. Pulling the cable may damage the port.**

Refer to your device manufacturer's owner information regarding the proper use and care of the device.

To connect an iPod® to the vehicle so that the iPod® can be controlled with the audio system controls and display screen, use the USB jack located on the center console below the heater and air conditioner controls. Connect the iPod®-specific end of the cable to the iPod® and the USB end of the cable to the USB jack on the vehicle. If your iPod® supports charging via a USB connection, its battery will be charged while connected to the vehicle with the ignition switch in the ACC or ON position.

While connected to the vehicle, the iPod® can only be operated by the vehicle audio controls.

To disconnect the iPod® from the vehicle, remove the USB end of the cable from the USB jack on the vehicle, then remove the cable from the iPod®.

\* iPod® is a trademark of Apple Inc., registered in the U.S. and other countries.

## Compatibility

The following models are compatible:

- iPod® Classic - 5th Generation (firmware version 1.3.0 or later)
- iPod® Classic - 6th Generation (firmware version 2.0.1 or later)
- iPod® Classic - 7th Generation (firmware version 2.0.4 or later)
- iPod® nano - 1st generation (firmware version 1.3.1 or later)
- iPod® nano - 2nd generation (firmware version 1.1.3 or later)
- iPod® nano - 3rd generation (firmware version 1.1.3 or later)
- iPod® nano - 4th generation (firmware version 1.0.4 or later)

- iPod® nano - 5th generation (firmware version 1.0.2 or later)
- iPod® nano - 6th generation (firmware version 1.1 or later)
- iPod® Touch - 2nd generation (firmware version 4.2.1 or later)
- iPod® Touch - 3rd generation (firmware version 5.1 or later) (minimum iOS 5.0 required for smartphone integration)
- iPod® Touch - 4th generation (firmware version 5.1 or later) (minimum iOS 5.0 required for smartphone integration)
- iPhone® 3G (firmware version 4.2.1 or later)
- iPhone® 3GS (firmware version 5.1 or later) (minimum iOS 5.0 required for smartphone integration)
- iPhone® 4 (firmware version 5.1 or later) (minimum iOS 5.0 required for smartphone integration)
- iPhone® 4S (firmware version 5.1 or later) (minimum iOS 5.0 required for smartphone integration)

Make sure that your iPod® firmware is updated to the version indicated above.

## Audio main operation

Place the ignition switch in the ACC or ON position. Press the MEDIA button repeatedly to switch to the iPod® mode.

If the system has been turned off while the iPod® was playing, pressing the VOL/  control knob will start the iPod®.

### iPod® MENU button (if so equipped):

Press the iPod® MENU button while the iPod® is connected to show the iPod® operation menu on the audio display. Scroll through the menu list using the TUNE/FOLDER control dial. Press ENTER/SETTING button to select a menu item. Items in the iPod® menu appear on the display in the following order:

- Now playing
- Playlists
- Artists
- Albums
- Songs
- Podcasts
- Genres
- Composers
- Audiobooks
- Shuffle songs

For more information about each item, see the iPod® Owner's Manual.

### SEEK/CAT and TRACK buttons:

When the ⏮ SEEK/CAT button or ⏭ TRACK button is pressed for less than 1.5 seconds while the iPod® is playing, the next track or the beginning of the current track on the iPod® will be played.

When the ⏮ SEEK/CAT button or ⏭ TRACK button is pressed for more than 1.5 seconds while the iPod® is playing, the iPod® will play while fast forwarding or rewinding. When the button is released, the iPod® will return to the normal play speed.

### REPEAT (RPT):

When the RPT button is pressed while a track is being played, the play pattern can be changed as follows:

Repeat Off → 1 Track Repeat → All Repeat → Repeat Off

1 Track Repeat: the current track will be repeated.

All Repeat: all songs in the current list are repeated.

Repeat Off: no repeat play pattern is applied.

## 4-70 Monitor, climate, audio, phone and voice recognition systems

### RANDOM (RDM):

When the RDM button is pressed while a track is being played, the play pattern can be changed as follows:

Shuffle Off → Track Shuffle → Album Shuffle → Shuffle Off

Track Shuffle: the tracks in the current list will be played randomly.

Album Shuffle: the albums in the current list will be played randomly.

Shuffle Off: no random play pattern is applied.

### BACK button:

When the BACK button is pressed, it returns to the previous menu.

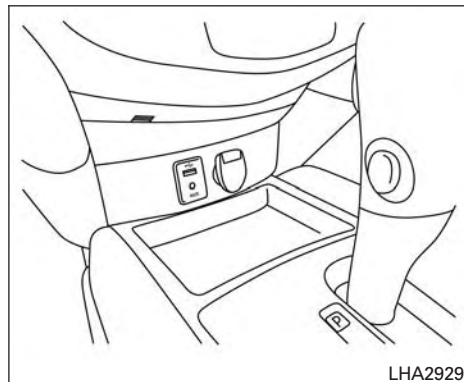

LHA2929

## iPod®\* PLAYER OPERATION WITH NAVIGATION SYSTEM (if so equipped)

### Connecting iPod®

#### WARNING

**Do not connect, disconnect, or operate the USB device while driving. Doing so can be a distraction. If distracted you could lose control of your vehicle and cause an accident or serious injury.**

## CAUTION

- **Do not force the USB device into the USB port. Inserting the USB device tilted or up-side-down into the port may damage the port. Make sure that the USB device is connected correctly into the USB port.**
- **Do not grab the USB port cover (if so equipped) when pulling the USB device out of the port. This could damage the port and the cover.**
- **Do not leave the USB cable in a place where it can be pulled unintentionally. Pulling the cable may damage the port.**

Refer to your device manufacturer's owner information regarding the proper use and care of the device.

To connect an iPod® to the vehicle so that the iPod® can be controlled with the audio system controls and display screen, use the USB jack located on the center console below the heater and air conditioner controls. Connect the iPod®-specific end of the cable to the iPod® and the USB end of the cable to the USB jack on the vehicle. If your iPod® supports charging via a USB connection, its battery will be charged while connected to the vehicle with the ignition switch in the ACC or ON position.

While connected to the vehicle, the iPod® can only be operated by the vehicle audio controls.

To disconnect the iPod® from the vehicle, remove the USB end of the cable from the USB jack on the vehicle, then remove the cable from the iPod®.

\* iPod® is a trademark of Apple Inc., registered in the U.S. and other countries.

## Compatibility

The following models are compatible:

- iPod® Classic 5th generation (firmware version 1.3.0 or later)
- iPod® Classic 6th generation (firmware version 2.0.1 or later)
- iPod® Classic 7th generation (firmware version 2.0.4 or later)
- iPod® Touch 2nd generation (firmware version 4.2.1 or later)\*
- iPod® Touch 3rd generation (firmware version 5.1 or later)
- iPod® Touch 4th generation (firmware version 5.1 or later)
- iPod® nano - 1st generation (firmware version 1.3.1 or later)

- iPod® nano - 2nd generation (firmware version 1.1.3 or later)
- iPod® nano - 3rd generation (firmware version 1.1.3 or later)
- iPod® nano - 4th generation (firmware version 1.0.4 or later)
- iPod® nano - 5th generation (firmware version 1.0.2 or later)
- iPod® nano - 6th generation (firmware version 1.1 or later)
- iPhone® 3G (firmware version 4.2.1 or later)
- iPhone® 3GS (firmware version 5.1 or later)
- iPhone® 4 (firmware version 5.1 or later)
- iPhone® 4S (firmware version 5.1 or later)

\* Some features of this iPod® may not be fully functional.

Make sure that your iPod® firmware is updated to the version indicated above.



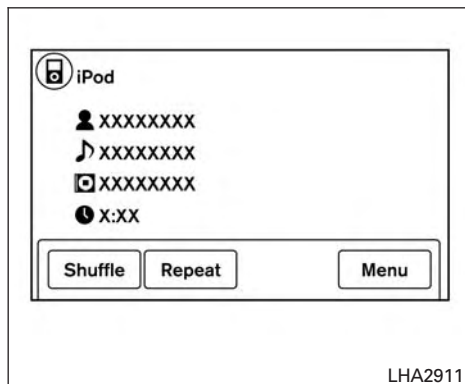

Audio main operation

#### AUX button:

When the AUX button is pressed with the system off and the iPod® connected, the system will turn on. If another audio source is playing and the iPod® is connected, press the AUX button repeatedly until the center display changes to the iPod® mode.

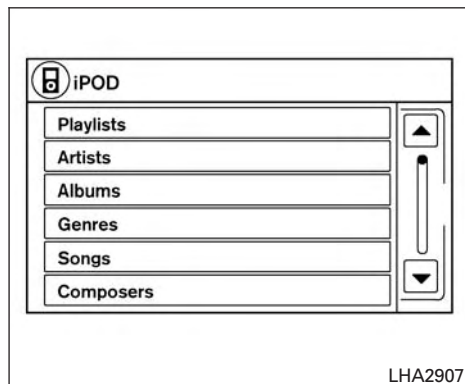

#### Interface:

The interface for iPod® operation shown on the vehicle's audio system display screen is similar to the iPod® interface. Use the touchscreen, BACK button or the scrolling knob to navigate the menus on the screen.

When the iPod® is playing, touch the "Menu" key to bring up the iPod® interface.

Depending on the iPod® model, the following items may be available on the menu list screen. For further information about each item, see the iPod® Owner's Manual.

- Playlists

- Artists
- Albums
- Genres
- Songs
- Composers
- Audiobooks
- Podcasts

#### Shuffle and repeat play mode:

While the iPod® is playing, the play pattern can be altered so that songs are repeated or played randomly.

#### Shuffle:

Touch the "Shuffle" key to apply a random play pattern to the iPod®. When the Shuffle mode is active, the text is illuminated. Touching the "Shuffle" key once more will display the "Shuffle songs" key. To cancel Shuffle mode, touch the "Shuffle" key again until the text is no longer illuminated.

#### Repeat:

Touch the "Repeat" key to apply a repeat play pattern to the iPod®. When the repeat mode is active, the text is illuminated. Touching the "Repeat" key once more will display the "Repeat

song” key. To cancel Repeat mode, touch the “Repeat” key again until the text is no longer illuminated.



Press the seek button ◀◀ or ▶▶ to skip backward or forward one track.

Press and hold the seek button ◀◀ or ▶▶ for 1.5 seconds while a track is playing to reverse or fast forward the track being played. The track plays at an increased speed while reversing or fast forwarding. When the button is released, the track returns to normal play speed.

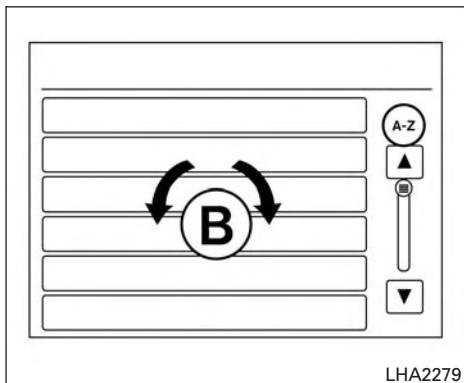

#### Scrolling menus:

While navigating long lists of artists, albums or songs in the music menu, it is possible to scroll the list by the first character in the name. To activate character indexing, touch and hold the “A-Z” key in the upper right corner of the screen. Turn the TUNE/SCROLL knob to choose the number or letter to jump to in the list and then press the ENTER button.

If no character is selected after two seconds, the display returns to normal.

#### BLUETOOTH® STREAMING AUDIO WITHOUT NAVIGATION SYSTEM (if so equipped)

If you have a compatible Bluetooth® audio device that is capable of playing audio files, the device can be connected to the vehicle's audio system so that the audio files on the device play through the vehicle's speakers.

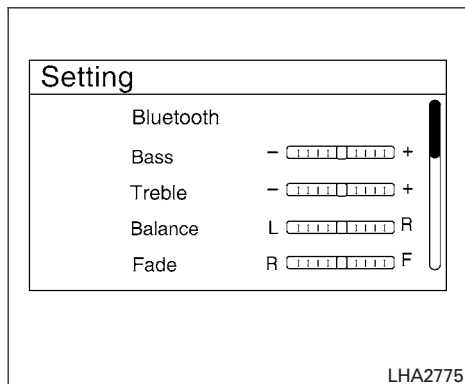

### Connecting Bluetooth® audio

To connect your Bluetooth® audio device to the vehicle, follow the procedure below:

1. Press the SETTING button.
2. Select the “Bluetooth” key.
3. Select the “Add Telephone or Device” key. This same screen can be accessed to remove, replace or select a different Bluetooth® device.

4. The system acknowledges the command and asks you to initiate connecting from the phone handset. The connecting procedure of the cellular phone varies according to each cellular phone model. See the cellular phone Owner’s Manual for details. You can also visit [www.nissanusa.com/bluetooth](http://www.nissanusa.com/bluetooth) for instructions on connecting NISSAN recommended cellular phones.

### Audio main operation

To switch to the Bluetooth® audio mode, press the MEDIA button repeatedly until the Bluetooth® audio mode is displayed on the screen.

The controls for the Bluetooth® audio are displayed on the screen. Use the Preset 3 button for play and the Preset 4 button for pause.

### BLUETOOTH® STREAMING AUDIO WITH NAVIGATION SYSTEM (if so equipped)

If you have a compatible Bluetooth® audio device that is capable of playing audio files, the device can be connected to the vehicle’s audio system so that the audio files on the device play through the vehicle’s speakers.

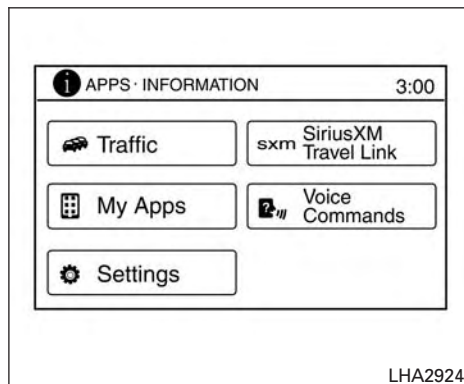

### Connecting Bluetooth® audio

To connect your Bluetooth® audio device to the vehicle, follow the procedure below:

1. Press the [APPS·I] button.
2. Touch the “Settings” key.
3. Touch the “Phone & Bluetooth” key.

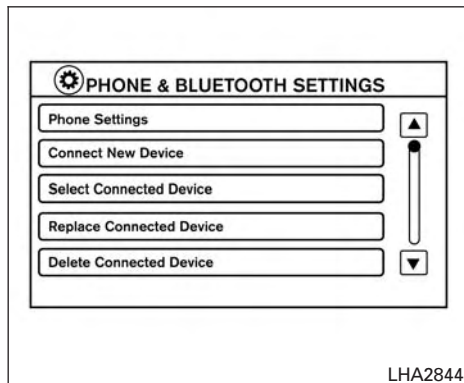

4. Touch the "Connect New Device" key.
5. The system acknowledges the command and asks you to initiate connecting from the phone handset. The connecting procedure of the cellular phone varies according to each cellular phone model. See the cellular phone Owner's Manual for details. You can also visit [www.nissanusa.com/bluetooth](http://www.nissanusa.com/bluetooth) for instructions on connecting NISSAN recommended cellular phones.

## Audio main operation

To switch to the Bluetooth® audio mode, press the AUX button repeatedly until the Bluetooth® audio mode is displayed on the screen.

The controls for the Bluetooth® audio are displayed on the screen.

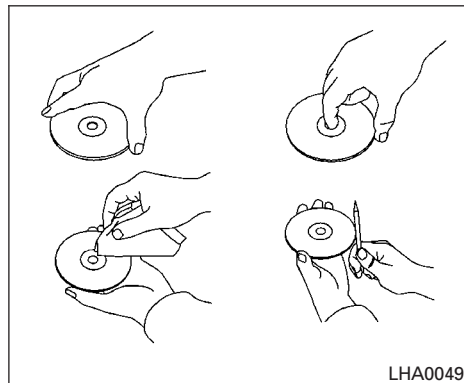

## CD CARE AND CLEANING

- Handle a CD by its edges. Do not bend the disc. Never touch the surface of the disc.
- Always place the discs in the storage case when they are not being used.
- To clean a disc, wipe the surface from the center to the outer edge using a clean, soft cloth. Do not wipe the disc using a circular motion.
- Do not use a conventional record cleaner or alcohol intended for industrial use.

- A new disc may be rough on the inner and outer edges. Remove the rough edges by rubbing the inner and outer edges with the side of a pen or pencil as illustrated.

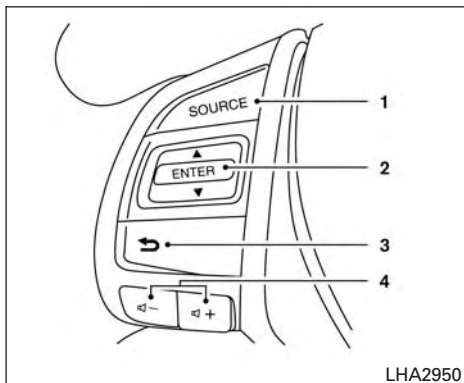

1. Source select and power on switch
2. Menu control switch/ENTER button
3. ↶ (Back) switch
4. Volume control switch

### STEERING WHEEL SWITCH FOR AUDIO CONTROL

#### POWER on switch

With the ignition switch in the ACC or ON position, push the SOURCE switch to turn the audio system on.

### SOURCE select switch

Push the source select switch to change the mode in the following sequence:

AM → FM1 → FM2 → SXM1 (satellite radio, if so equipped) → SXM2 (satellite radio, if so equipped) → SXM3 (satellite radio, if so equipped) → CD\* → USB/iPod®\* → Bluetooth® Audio\* → Audio App\* → AUX\* → AM.

\* These modes are only available when compatible media storage is inserted into the device or connected to the system.

### Volume control switch

Push the volume control switch to increase or decrease the volume.



Menu control  
switch/ENTER button

While the display is showing a map or audio screen, tilt the Menu Control switch upward or downward to select a station, track, CD or folder. For most audio sources, tilting the switch up/down for more than 1.5 seconds provides a different function than a tilting up/down for less than 1.5 seconds.

### **AM and FM:**

- Tilt up/down for less than 1.5 seconds to increase or decrease the preset station.
- Tilt up/down for more than 1.5 seconds to seek up or down to the next station.
- Press the ENTER button to show the list of preset stations.

### **XM/SXM (if so equipped):**

- Tilt up/down for less than 1.5 seconds to increase or decrease the preset station.
- Tilt up/down for more than 1.5 seconds to go to the next or previous channel.
- Press the ENTER button to show the XM/SXM Menu.

### **iPod®:**

- Tilt up/down for less than 1.5 seconds to increase or decrease the track number.
- Press the ENTER button to show the iPod Menu.

### **CD:**

- Tilt up/down for less than 1.5 seconds to increase or decrease the track number.

- Tilt up/down for more than 1.5 seconds to increase or decrease the folder number (if playing compressed audio files).
- Press the ENTER button to show the CD Menu.

### **USB:**

- Tilt up/down for less than 1.5 seconds to increase or decrease the track number.
- Tilt up/down for more than 1.5 seconds to increase or decrease the folder number.
- Press the ENTER button to show the USB Menu.

### **Bluetooth® Audio:**

- Tilt up/down for less than 1.5 seconds to skip ahead or back to the next song.
- Tilt up/down for more than 1.5 seconds to reverse or fast forward the current song.

### **AUX:**

- Press the ENTER button to show the AUX Menu.

## **ANTENNA**

The antenna cannot be shortened, but can be removed. When you need to remove the antenna, turn the antenna rod counterclockwise.

To install the antenna rod, turn the antenna rod clockwise and hand tighten.

### **CAUTION**

- **Always properly tighten the antenna rod during installation or the antenna rod may break during vehicle operation.**
- **Be sure that the antenna is removed before the vehicle enters an automatic car wash.**
- **Be sure to fold down the antenna before the vehicle enters a garage with a low ceiling.**

## **NISSANCONNECT™ APP SMARTPHONE INTEGRATION (if so equipped)**

This vehicle is equipped with Smartphone Integration technology. This allows many compatible Smartphone applications to be displayed and easily controlled through the vehicle's touchscreen.

### **NOTE:**

**A compatible smartphone and registration is required to use mobile applications or to access connected features of certain vehicle applications.**

## **REGISTERING WITH NISSANCONNECT™ APP**

To use the Smartphone Integration feature, it is necessary for the user to register. In order to register, visit the NissanConnect™ website, [www.nissanusa.com/connect/](http://www.nissanusa.com/connect/) and sign up or create an account through the prompts on the NissanConnect™ App. Once registered, download the NissanConnect™ App from your compatible phone's application download source and then log into the application. If you already have an account created through the App, please log in.

## **CONNECT PHONE**

To use this feature, a compatible smartphone must be connected via Bluetooth® or USB to the vehicle. For more information on connecting your phone, see Bluetooth® Hands-Free Phone System without Navigation System (Type B)™ or "Bluetooth® Hands-Free Phone System with Navigation System" in this section.

### **NOTE:**

**For vehicles with navigation, Apple iPhones REQUIRE the phone to be plugged in via USB for NissanConnect™ Apps to function.**

**For vehicles without Navigation, Apple iPhones must be paired via Bluetooth for NissanConnect™ Apps to function.**

### **NOTE:**

**For Android phones, NissanConnect™ Apps REQUIRES the phone to be paired via Bluetooth.**

## **APPLICATION DOWNLOAD**

Once connected, the NissanConnect™ App will search your phone to determine which compatible applications are currently installed. The user will then choose which apps they want to bring into their vehicle from the list of apps within the "Manage My Apps" section of the NissanConnect™ App on their smartphone. The vehicle will then download the in-vehicle interface for each of these compatible applications. Once downloaded, the user can access their selected smartphone applications through the vehicle touchscreen. For more information on application availability see [www.nissanusa.com/connect/](http://www.nissanusa.com/connect/)

## CAR PHONE OR CB RADIO

When installing a CB, ham radio or car phone in your vehicle, be sure to observe the following precautions; otherwise, the new equipment may adversely affect the engine control system and other electronic parts.

### WARNING

- A cellular phone should not be used for any purpose while driving so full attention may be given to vehicle operation. Some jurisdictions prohibit the use of cellular phones while driving.
- If you must make a call while your vehicle is in motion, the hands free cellular phone operational mode is highly recommended. Exercise extreme caution at all times so full attention may be given to vehicle operation.
- If you are unable to devote full attention to vehicle operation while talking on the phone, pull off the road to a safe location and stop your vehicle.

### CAUTION

- Keep the antenna as far away as possible from the electronic control modules.
- Keep the antenna wire more than 8 in (20 cm) away from the electronic control system harnesses. Do not route the antenna wire next to any harness.
- Adjust the antenna standing-wave ratio as recommended by the manufacturer.
- Connect the ground wire from the CB radio chassis to the body.
- For details, consult a NISSAN dealer.

## BLUETOOTH® HANDS-FREE PHONE SYSTEM WITHOUT NAVIGATION SYSTEM (if so equipped)

### WARNING

- Use a phone after stopping your vehicle in a safe location. If you have to use a phone while driving, exercise extreme caution at all times so full attention may be given to vehicle operation.
- If you are unable to devote full attention to vehicle operation while talking on the phone, pull off the road to a safe location and stop your vehicle.

### CAUTION

To avoid discharging the vehicle battery, use a phone after starting the engine.



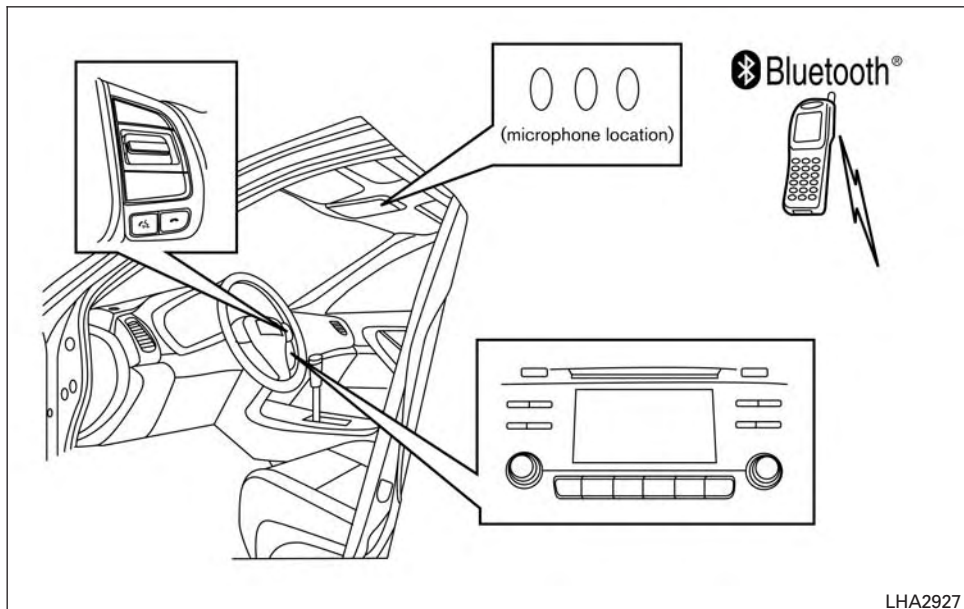

Your NISSAN is equipped with the Bluetooth® Hands-Free Phone System. If you have a compatible Bluetooth® enabled cellular phone, you can set up the wireless connection between your cellular phone and the in-vehicle phone module. With Bluetooth® wireless technology, you can

make or receive a hands-free telephone call with your cellular phone in the vehicle.

Once your cellular phone is connected to the in-vehicle phone module, no other phone connecting procedure is required. Your phone is automatically connected with the in-vehicle

phone module when the ignition switch is placed in the ON position with the previously connected cellular phone turned on and carried in the vehicle.

**NOTE:**

**Some devices require the user to accept connections to other Bluetooth® devices. If your phone does not connect automatically to the system, consult the phone's Owner's Manual for details on device operation.**

You can connect up to 5 different Bluetooth® cellular phones to the in-vehicle phone module. However, you can talk on only one cellular phone at a time.

Before using the Bluetooth® Hands-Free Phone System, refer to the following notes.

- Set up the wireless connection between a compatible cellular phone and the in-vehicle phone module before using the hands-free phone system.
- Some Bluetooth® enabled cellular phones may not be recognized or work properly. Please visit [www.nissanusa.com/bluetooth](http://www.nissanusa.com/bluetooth) for a recommended phone list and connecting instructions.

- You will not be able to use a hands-free phone under the following conditions:
  - Your vehicle is outside of the cellular service area.
  - Your vehicle is in an area where it is difficult to receive a cellular signal; such as in a tunnel, in an underground parking garage, near a tall building or in a mountainous area.
  - Your cellular phone is locked to prevent it from being dialed.
- When the radio wave condition is not ideal or ambient sound is too loud, it may be difficult to hear the other person's voice during a call.
- Do not place the cellular phone in an area surrounded by metal or far away from the in-vehicle phone module to prevent tone quality degradation and wireless connection disruption.
- While a cellular phone is connected through the Bluetooth® wireless connection, the battery power of the cellular phone may discharge quicker than usual. The Bluetooth® Hands-Free Phone System cannot charge cellular phones.

- If the hands-free phone system seems to be malfunctioning, see "Troubleshooting guide" in this section. You can also visit [www.nissanusa.com/bluetooth](http://www.nissanusa.com/bluetooth) for troubleshooting help.
- Some cellular phones or other devices may cause interference or a buzzing noise to come from the audio system speakers. Storing the device in a different location may reduce or eliminate the noise.
- Refer to the cellular phone Owner's Manual regarding the telephone charges, cellular phone antenna and body, etc.

## REGULATORY INFORMATION

### FCC Regulatory information

- CAUTION: To maintain compliance with FCC's RF exposure guidelines, use only the supplied antenna. Unauthorized antenna, modification, or attachments could damage the transmitter and may violate FCC regulations.
- Operation is subject to the following two conditions:
  1. This device may not cause interference and
  2. this device must accept any interference, including interference that may cause undesired operation of the device.

### IC Regulatory information

- Operation is subject to the following two conditions: (1) this device may not cause interference, and (2) this device must accept any interference, including interference that may cause undesired operation of the device.
- This Class B digital apparatus meets all requirements of the Canadian Interference-Causing Equipment Regulations.

BLUETOOTH® is a trademark owned by Bluetooth SIG, Inc. and licensed to Visteon.



## USING THE SYSTEM

The NISSAN Voice Recognition system allows hands-free operation of the Bluetooth® Phone System.

If the vehicle is in motion, some commands may not be available so full attention may be given to vehicle operation.

## Initialization

When the ignition switch is placed in the ON position, NISSAN Voice Recognition is initialized, which takes a few seconds. If the  button is pressed before the initialization completes, the system will announce "Hands-free phone system not ready" and will not react to voice commands.

## Operating tips

To get the best performance out of the NISSAN Voice Recognition system, observe the following:

- Keep the interior of the vehicle as quiet as possible. Close the windows to eliminate surrounding noises (traffic noises, vibration sounds, etc.), which may prevent the system from recognizing voice commands correctly.
- Wait until the tone sounds before speaking a command. Otherwise, the command will not be received properly.
- Start speaking a command within 5 seconds after the tone sounds.

- Speak in a natural voice without pausing between words.

## Giving voice commands

To operate NISSAN Voice Recognition, press and release the  button located on the steering wheel. After the tone sounds, speak a command.

The command given is picked up by the microphone, and voice feedback is given when the command is accepted.

- If you need to hear the available commands for the current menu again, say "Help" and the system will repeat them.
- If a command is not recognized, the system announces, "Command not recognized. Please try again." Make sure the command is said exactly as prompted by the system and repeat the command in a clear voice.
- If you want to go back to the previous command, you can say "Go back" or "Correction" any time the system is waiting for a response.

- You can cancel a command when the system is waiting for a response by saying, "Cancel" or "Quit." The system announces "Cancel" and ends the VR session. You can also press and hold the  button on the steering wheel for 5 seconds at any time to end the VR session. Whenever the VR session is cancelled, a double beep is played to indicate you have exited the system.
- If you want to adjust the volume of the voice feedback, press the volume control switches (+ or -) on the steering wheel while being provided with feedback. You can also use the radio volume control knob.

## Voice Prompt Interrupt

In most cases you can interrupt the voice feedback to speak the next command by pressing the  button on the steering wheel. After interrupting the system, wait for a beep before speaking your command.

## One Shot Call

To use the system faster, you may speak the second level commands with the main menu command on the main menu. For example, press the  button and after the tone say, "Call Redial".

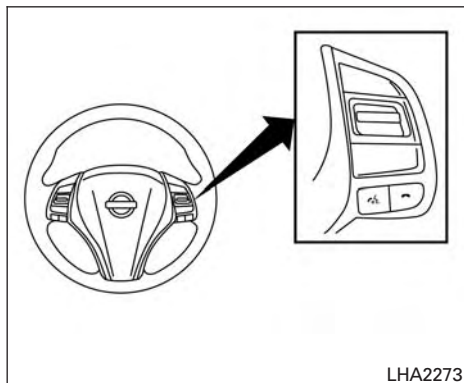

## CONTROL BUTTONS

The control buttons for the Bluetooth® Hands-Free Phone System are located on the steering wheel.



### PHONE/SEND

Press the  button to initiate a VR session or answer an incoming call.



You can also use the  button to interrupt the system feedback and give a command at once. See “Voice Commands” and “During a call” in this section for more information.

### PHONE/END

While the voice recognition system is active, press and hold the  button for 5 seconds to quit the voice recognition system at any time.



### Tuning switch

While using the voice recognition system, tilt the tuning switch up or down to manually control the phone system.

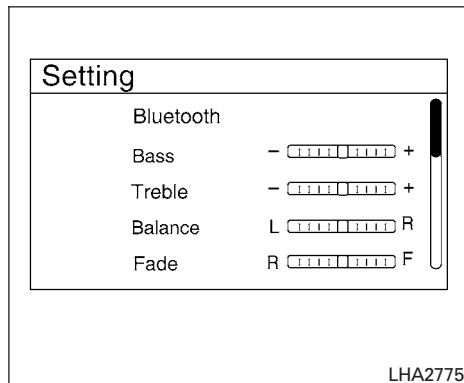

## CONNECTING PROCEDURE

### NOTE:

**The connecting procedure must be performed when the vehicle is stationary. If the vehicle starts moving during the procedure, the procedure will be cancelled.**

To connect a phone to the Bluetooth® Hands-Free Phone System:

1. Press the SETTING button.
2. Use the TUNE/FOLDER or TUNE/SCROLL knob to select “Bluetooth” and then press the ENTER button.

Menu Item		Result
Bluetooth ON/OFF		Allows user to switch Bluetooth on and off. Bluetooth must be turned on in order to connect device.
	On	Turns Bluetooth functionality on
	Off	Turns Bluetooth functionality off
Add Phone or Device		Upon pressing this button, a message with a PIN appears on the screen. operate the Bluetooth phone to enter the PIN and complete the connection process.
Replace Phone		Replace the phone currently connected to the system. This option allows the user to keep any voicetags that were recorded using the previous phone if vehicle is equipped with voice recognition.

The connecting procedure varies according to each phone. See the phone's Owner's Manual for details. You can also visit [www.nissanusa.com/bluetooth](http://www.nissanusa.com/bluetooth) or call the NISSAN Consumer Affairs Department for instructions on connecting recommended cellular phones.

## VOICE COMMANDS

Voice commands can be used to operate the Bluetooth® Hands-Free Phone System. Press the  button and say “Phone” to bring up the phone command menu. The available options are:

- Call
- Phonebook
- Recent Calls
- Messaging (if available)
- Show Applications (if available)
- Select Phone or Device

### “Call”

For more information on the “Call” command, see “Making a call” in this section.

### “Phonebook”

The following commands are available under “Phonebook”:

- (a name)  
Say a name in the phonebook to bring up a list of options for that phonebook entry. The system will say the name it interpreted based on the voice command provided. If the name is incorrect, say “Correction” to hear another name.  
Once the correct phonebook entry is identified, say “Dial” to dial the number or “Send Text” to send a text message to that number. Say “Record Name” to record a name for the phonebook entry. Say “Delete Recording” to delete a recorded name for the phonebook entry.
- List Names  
Speak this command to have the system list the names in the phonebook one by one alphabetically. Say “Dial” to dial the number of the current name or “Send Text” to send a text message to that number. Say “Next Entry” or “Previous Entry” to move through the list alphabetically. Say “Record Name” to record a name for the current phonebook entry. Say “Delete Recording” to delete a recorded name for the current phonebook entry.

- Transfer Entry

This command can be used to transfer multiple contacts at a time. To enable manual contact transfer capability, set “Phonebook Download” to “Off” in the Setting menu. The ability to transfer contacts via the OPP Bluetooth profile depends on your mobile phone. See your phone’s Owner’s Manual for details and instructions.

- Delete Entry

Speak this command to delete an entry in the phonebook. Choose an entry to delete by speaking the desired name or say “List Names”.

### “Recent Calls”

The following commands are available under “Recent Calls”:

- Incoming Calls

Speak this command to list the last five incoming calls to the vehicle. If the call is from an entry in the phonebook, the name will be displayed. Otherwise, the phone number of the incoming call will be displayed.

Say “Dial” to call the number or “Send Text” to send a text message to that number. Say “Next Entry” or “Previous Entry” to move through the list of incoming calls.

- Missed Calls

Speak this command to list the last five missed calls to the vehicle. If the call is from an entry in the phonebook, the name will be displayed. Otherwise, the phone number of the missed call will be displayed.

Say “Dial” to call the number or “Send Text” to send a text message to that number. Say “Next Entry” or “Previous Entry” to move through the list of missed calls.

- Outgoing Calls

Speak this command to list the last five outgoing calls from the vehicle. If the call was to an entry in the phonebook, the name will be displayed. Otherwise, the phone number of the outgoing call will be displayed.

Say “Dial” to call the number or “Send Text” to send a text message to that number. Say “Next Entry” or “Previous Entry” to move through the list of outgoing calls.

- Redial

Speak this command to call the last number dialed.

- Call Back

Speak this command to call the number of the last incoming call to the vehicle.

## “Messaging”

Speak this command to access text messaging functions. For more information on these commands, see “Text messaging” in this section.

## “Show Applications”

Speak this command to display list of smartphone apps available.

### NOTE:

**Compatible smartphone and registration necessary to access applications. See “NissanConnect Mobile App Smart Phone Integration” in this section for more information**

## “Select Phone or Device”

Speak this command to select a phone to use from a list of those phones connected to the vehicle.

## MAKING A CALL



To make a call from a phone connected to the vehicle’s Bluetooth® Hands-Free Phone System:

1. Press the  button.
2. The system will prompt you for a command. Say “Call”.
3. Select one of the available voice commands to continue:
  - “(a name)” – Speak the name of a phonebook entry to place a call to that entry. The system will respond with the name it interpreted from your command and will prompt you to confirm that the name is correct. Say “Yes” to initiate the call or “No” to hear another name from the phonebook.

- “Number” – Speak this command to place a call by inputting numbers.  
For 7- and 10-digit phone numbers, speak the numbers. When finished, say “Dial” to initiate the call. Say “Correction” at any time in the process to correct a misspoken or misinterpreted number.  
For phone numbers with more digits or special characters, say “Special Number”, then speak the digits. Up to 24 digits can be entered. Available special characters are “star”, “pound”, “plus” and “pause”. When finished, say “Dial” to initiate the call. Say “Correction” at any time in the process to correct a misspoken or misinterpreted number or character.
- “Redial” – Speak this command to dial the number of the last outgoing call. The system will display “Redialing <name/number>”. The name of the phonebook entry will be displayed if it available, otherwise the number being redialed will be displayed.
- “Call Back” – Speak this command to dial the number of the last incoming call. The system will display “Calling back <name/number>”. The name of the phonebook entry will be displayed if it available, otherwise the number being called back will be displayed.

## RECEIVING A CALL



When a call is received by the phone connected to the vehicle’s Bluetooth® Hands-Free Phone System, the call information is displayed on either the vehicle information display or both the vehicle information display and the control panel display.

Press the  button to accept the call. Press the  button to reject the call.

## DURING A CALL



While a call is active, press the  button to access additional options. Speak one of the following commands:

- “Send” – Speak this command followed by the digits to enter digits during the phone call.
- “Mute On” or “Mute Off” – Speak the command to mute or unmute the system.
- “Transfer Call” – Speak this command to transfer the call to the handset. To transfer the call back from the handset to the Bluetooth® Hands-Free Phone System, press the  button and confirm when prompted.

If supported by the phone, the Bluetooth® Hands-Free Phone System allows for call waiting functionality. If a call is received while another call is already active, a message will be displayed on the screen. Press the  button to hold the active call and switch to the second call. Press the  button to reject the second call.

While the second call is active, pressing the  button will allow the same commands that available during any call as well as two additional commands:

- “Switch Call” – Speak this command to hold the second call and switch back to the original call.
- “End Other Call” – Speak this command to stay with the second call and end the original call.

Press the  button to accept the call. Press the  button to reject the call.

## ENDING A CALL

To end an active call, press the  button.



## TEXT MESSAGING

### WARNING

- **Laws in some jurisdictions may restrict the use of some of the applications and features, such as social networking and texting.**
- **Laws in some jurisdictions may restrict the use of “Text-to-Speech”. Check local regulations before using this feature.**
- **Use the text messaging feature after stopping your vehicle in a safe location. If you have to use the feature while driving, exercise extreme caution at all times so full attention may be given to vehicle operation.**
- **If you are unable to devote full attention to vehicle operation while using the text messaging feature, pull off the road to a safe location and stop your vehicle.**

### NOTE:

**This feature is automatically disabled if the connected device does not support the Message Access Profile (MAP). See the phone’s Owner’s Manual for details and instructions.**

4-88 **Monitor, climate, audio, phone and voice recognition systems**

The system allows for the sending and receiving of text messages through the vehicle interface.

### **Sending a text message:**

1. Press the  button.
2. Say “Messaging”.
3. Say “Send Text”.
4. The system will provide a list of available commands in order to determine the recipient of the text message. Choose from the following:
  - (A name)
  - Number
  - Incoming Calls
  - Outgoing Calls
  - Missed Calls

If “Incoming Calls”, “Outgoing Calls”, or “Missed Calls” is selected, the following additional commands will be displayed:

- Send Text
- Next Entry
- Previous Entry

For more information about these options, see “Voice commands” in this section.



5. Once a recipient is chosen, the system prompts for which message to send. Five predefined messages are available as well as three custom messages. To choose one of the predefined messages, speak one of the following:

- “Driving, can’t text”
- “Call me”
- “On my way”
- “Running late”
- “Okay”

To send one of the custom messages, say “Custom Message”. If more than one custom message is stored, the system will prompt for the number of the desired custom message. For more information on setting and managing custom text messages, see “Bluetooth® settings” in this section.

### **Reading a received text message:**

1. Press the  button.
2. Say “Messaging”.
3. Say “Read Text”.

The text message, sender and delivery time are shown on the screen. Use the tuning switch on the steering wheel to scroll through all text messages if more than one are available. Press the  button to exit the text message screen. Press the  button to access the following options for replying to the text message:

- Call Back  
Speak this command to call the sender of the text message using the Bluetooth® Hands-Free Phone System.
- Send Text  
Speak this command to send a text message response to the sender of the text message.
- Read Text  
Speak this command to read the text message again.
- Previous Text  
Speak this command to move to the previous text message (if available).
- Next Text  
Speak this command to move to the next text message (if available).

#### NOTE:

**Text messages are only displayed if the vehicle speed is less than 5 mph (8 km/h).**

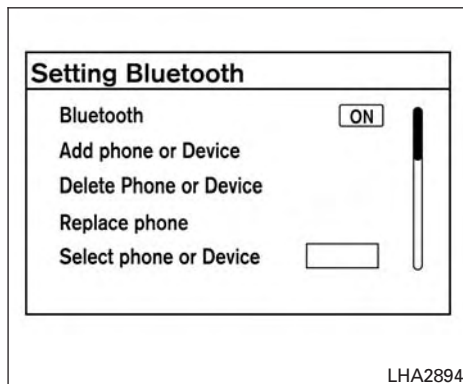

### BLUETOOTH® SETTINGS

To access and adjust the settings for the Bluetooth® Hands-Free Phone System:



1. Press the SETTING button.
  2. Use the TUNE/SCROLL or TUNE/FOLDER knob to select "Bluetooth" and then press the ENTER button:
- Bluetooth  
Select "On" or "Off" to turn the vehicle's Bluetooth® system on or off.
  - Add Phone or Device  
To connect a phone to the system, see "Connecting procedure" in this section.



- Delete Phone or Device  
Select to delete a phone from the displayed list. The system will ask to confirm before deleting the phone.
- Replace Phone  
Select to replace a phone from the displayed list. When a selection is made, the system will ask to confirm before proceeding. The recorded phonebook for the phone being deleted will be saved as long as the new phone's phonebook is the same as the old phone's phonebook.
- Select Phone or Device  
Select to connect to a previously connected phone from the displayed list.
- Phonebook Download  
Select to turn on or off the automatic download of a connected phone's phonebook.
- Show Incoming Calls  
Select "Driver Only" to have incoming call information displayed only in the vehicle information display. Select "Both" to have incoming call information displayed in both the vehicle information display and the center display screen.
- Text Message  
Select to turn on or off the vehicle's text messaging feature.

- **New Text Sound**  
Select to adjust the volume of the sound that plays when a new text is received by a phone connected to the Bluetooth® Hands-Free Phone System. The setting all the way to the left indicates that the new text sound will be muted.
- **Show Incoming Text**  
Select “Driver Only” to have incoming text messages displayed only in the vehicle information display. Select “Both” to have incoming text messages displayed in both the vehicle information display and the center display screen. Select “None” to have no display of incoming text messages.
- **Edit Custom Messages**  
Select to set a custom message that will be available with the standard options when sending a text message. To set a custom message, send a text message to your own phone number while the phone is connected to the system. Three custom messages can be set. Custom messages can only be set while the vehicle is stationary.

- **Auto Reply**  
Select to turn on or off the Auto Reply function. When enabled, the vehicle will automatically send a predefined text message to the sender when a text message is received while driving.
- **Auto Reply Message**  
Select to choose the message that is sent when the Auto Reply function is enabled. Choose from “I’m Driving” or one of the three custom messages stored in the system.
- **Vehicle Signature On/Off**  
Select to choose whether or not the vehicle signature is added to outgoing text messages from the vehicle. This message cannot be changed or customized.

## MANUAL CONTROL

While using the Voice Recognition system, it is possible to select menu options by using the steering wheel controls instead of speaking voice commands. To activate manual control mode, press the PHONE/SEND (  ) button on the steering wheel to access the phone menu and then press either up or down on the tuning switch (  ).

The manual control mode does not allow dialing a phone number by digits. The user may select an entry from the Phonebook or Recent Calls lists. To reactivate Voice Recognition, exit the manual control mode by pressing and holding the PHONE/END (  ) button. At that time, pressing the PHONE/SEND (  ) button will start the Hands Free Phone System.

## BLUETOOTH® HANDS-FREE PHONE SYSTEM WITH NAVIGATION SYSTEM (if so equipped)

### ⚠ WARNING

- Use a phone after stopping your vehicle in a safe location. If you have to use a phone while driving, exercise extreme caution at all times so full attention may be given to vehicle operation.
- If you are unable to devote full attention to vehicle operation while talking on the phone, pull off the road to a safe location and stop your vehicle.

### ⚠ CAUTION

To avoid discharging the vehicle battery, use a phone after starting the engine.

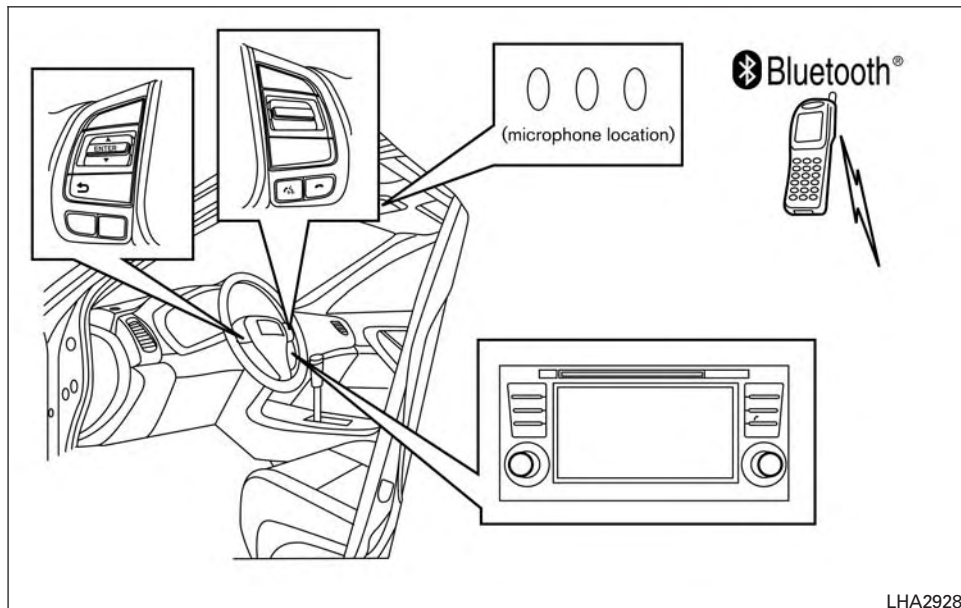

LHA2928

Your NISSAN is equipped with the Bluetooth® Hands-Free Phone System. If you have a compatible Bluetooth® enabled cellular phone, you can set up the wireless connection between your cellular phone and the in-vehicle phone module. With Bluetooth® wireless technology, you can

make or receive a hands-free telephone call with your cellular phone in the vehicle.

Once your cellular phone is connected to the in-vehicle phone module, no other phone connecting procedure is required. Your phone is automatically reconnected with the in-vehicle

phone module when the ignition switch is placed in the ON position with the connected cellular phone turned on and carried in the vehicle.

You can register up to 5 different Bluetooth® cellular phones to the in-vehicle phone module. However, you can talk on only one cellular phone at a time.

NISSAN Voice Recognition system supports the phone commands, so dialing a phone number using your voice is possible. For more details, see “NISSAN Voice Recognition System” in this section.

Before using the Bluetooth® Hands-Free Phone System, refer to the following notes.

- Set up the wireless connection between a cellular phone and the in-vehicle phone module before using the hands-free phone system.
- Some Bluetooth® enabled cellular phones may not be recognized by the in-vehicle phone module. Please visit [www.nissanusa.com/bluetooth](http://www.nissanusa.com/bluetooth) for a recommended phone list and connecting.
- You will not be able to use a hands-free phone under the following conditions:
  - Your vehicle is outside of the cellular service area.

- Your vehicle is in an area where it is difficult to receive cellular signal; such as in a tunnel, in an underground parking garage, near a tall building or in a mountainous area.

- Your cellular phone is locked to prevent it from being dialed.

- When the radio wave condition is not ideal or ambient sound is too loud, it may be difficult to hear the other person’s voice during a call.
- Immediately after the ignition switch is placed in the ON position, it may be impossible to receive a call for a short period of time.
- Do not place the cellular phone in an area surrounded by metal or far away from the in-vehicle phone module to prevent tone quality degradation and wireless connection disruption.
- While a cellular phone is connected through the Bluetooth® wireless connection, the battery power of the cellular phone may discharge quicker than usual. The Bluetooth® Hands-Free Phone System cannot charge cellular phones.

- If the hands-free phone system seems to be malfunctioning, see “Troubleshooting guide” in this section. You can also visit [www.nissanusa.com/bluetooth](http://www.nissanusa.com/bluetooth) for troubleshooting help.

- Some cellular phones or other devices may cause interference or a buzzing noise to come from the audio system speakers. Storing the device in a different location may reduce or eliminate the noise.

- Refer to the cellular phone owner’s manual regarding the telephone charges, cellular phone antenna and body, etc.

- The signal strength display on the monitor will not coincide with the signal strength display of some cellular phones.

## REGULATORY INFORMATION

### FCC Regulatory information

- CAUTION: To maintain compliance with FCC’s RF exposure guidelines, use only the supplied antenna. Unauthorized antenna, modification, or attachments could damage the transmitter and may violate FCC regulations.

- Operation is subject to the following two conditions:

1. This device may not cause interference and

2. this device must accept any interference, including interference that may cause undesired operation of the device.

#### IC Regulatory information

- Operation is subject to the following two conditions: (1) this device may not cause interference, and (2) this device must accept any interference, including interference that may cause undesired operation of the device.
- This Class B digital apparatus meets all requirements of the Canadian Interference-Causing Equipment Regulations.



BLUETOOTH® is a trademark owned by Bluetooth SIG, Inc. and licensed to Bosch.

#### VOICE COMMANDS

You can use voice commands to operate various Bluetooth® Hands-Free Phone System features using the NISSAN Voice Recognition system. For more details, see “NISSAN Voice Recognition System” in this section.

#### Voice Prompt Interrupt

While using the voice recognition system, the system voice can be interrupted to allow the user to speak commands. While the system is speaking, press the  button on the steering wheel. The system voice will stop and a tone will be heard. After the tone, speak desired command (displayed on the touchscreen).

#### One Shot Call

To use the system faster, you may speak the second level commands with the main menu command on the main menu. For example, press the  button and after the tone say, “Call Redial”.

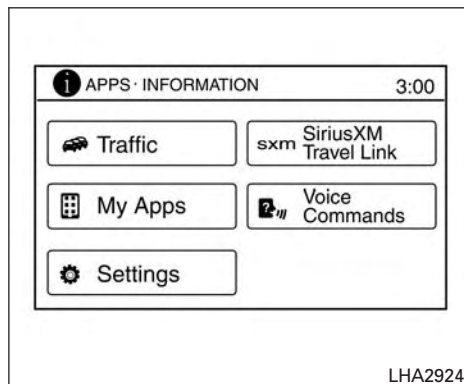

#### CONNECTING PROCEDURE

##### NOTE:

**The connecting procedure must be performed when the vehicle is stationary. If the vehicle starts moving during the procedure, the procedure will be cancelled.**

1. Press the [APPS] button on the control panel.
2. Touch the “Settings” key.
3. Touch the “Phone & Bluetooth” key.
4. Touch the “Connect New Device” key.

- Initiate the connecting process from the handset. The system will display the message: "Is PIN XXXXXX displayed on your Bluetooth device?". If the PIN is displayed on your Bluetooth® device, select "Yes" to complete the pairing process.

For more information, see the Bluetooth® device's Owner's Manual.

## VEHICLE PHONEBOOK

To access the vehicle phonebook:



- Press the  button on the control panel.
- Touch the "Phonebook" key.
- Choose the desired entry from the displayed list.
- The number of the entry will be displayed on the screen. Touch the number to initiate dialing.

### NOTE:

**To scroll quickly through the list, touch the "A-Z" key in the upper right corner of the screen. Turn the TUNE/SCROLL knob to choose a letter or number and then press ENTER. The list will move to the first entry that begins with that number or letter.**

## MAKING A CALL

To make a call, follow the procedure below:

- Press the  button on the control panel. The "Phone" screen will appear on the display.
- Select one of the following options to make a call:
  - "Phonebook": Select the name from an entry stored in the vehicle phonebook.
  - "Call Lists": Select the name from the incoming, outgoing or missed.
  - "Redial": Dial the last outgoing call from the vehicle.
  - : Input the phone number manually using a keypad displayed on the screen. For information on how to use the touch screen, see "How to use the touch screen" in this section.

## RECEIVING A CALL

When a call is placed to the connected phone, the display will change to phone mode.

To accept the incoming call, either:

- Press the  button on the steering wheel, or

- Touch the  icon on the screen.

To reject the incoming call, either:



- Press the  button on the steering wheel, or
- Touch the red phone icon on the screen.

## DURING A CALL

While a call is active, the following options are available on the screen:

- "Handset"  
Select this option to switch control of the phone call over to the handset.
- "Mute Mic."  
Select this option to mute the microphone. Select again to unmute the microphone.
- Red phone () icon  
Select to end the phone call.

## ENDING A CALL

To end a phone call, select the red phone () icon on the screen or press the  button on the steering wheel.

## TEXT MESSAGING

### WARNING

- **Laws in some jurisdictions may restrict the use of some of the applications and features, such as social networking and texting.**
- **Laws in some jurisdictions may restrict the use of “Text-to-Speech”. Check local regulations before using this feature.**
- **Use the text messaging feature after stopping your vehicle in a safe location. If you have to use the feature while driving, exercise extreme caution at all times so full attention may be given to vehicle operation.**
- **If you are unable to devote full attention to vehicle operation while using the text messaging feature, pull off the road to a safe location and stop your vehicle.**

The system allows for the sending and receiving of text messages through the vehicle interface.

### **Sending a text message:**

1. Press the  button on the steering wheel.
2. Say “Phone” after the tone.
3. Say “Send Text” after the tone.
4. The system will provide a list of available commands in order to determine the recipient of the text message. Choose from the following:
  - To (a name)
  - Enter Number
  - Missed Calls
  - Incoming Calls
  - Outgoing Calls

For more information about these options, see “Voice commands” in this section.

5. Once a recipient is chosen, the system prompts for which message to send. Nine predefined messages are available as well as three custom messages. To choose one of the predefined messages, speak one of the following after the tone:
  - “Driving, can’t text”
  - “Call me”



- “On my way”
- “Running late”
- “Okay”
- “Yes”
- “No”
- “Where are you?”
- “When?”

To send one of the custom messages, say “Custom Messages”. If more than one custom message is stored, the system will prompt for the number of the desired custom message. For more information on setting and managing custom text messages, see “Bluetooth® settings” in this section.

### **Reading a received text message:**

1. Press the  button on the steering wheel.
2. Say “Phone” after the tone.
3. Say “Read Text” after the tone.



The text message, sender and delivery time are shown on the screen. Use the tuning switch to scroll through all text messages if more than one are available. Press the  button to exit the text message screen. Press the  button to access the following options for replying to the text message:

- Call Back  
Speak this command to call the sender of the text message using the Bluetooth® Hands-Free Phone System.
- Send Text  
Speak this command to send a text message response to the sender of the text message.
- Read Text  
Speak this command to read the text message again.
- Previous Text  
Speak this command to move to the previous text message (if available).
- Next Text  
Speak this command to move to the next text message (if available).

#### **NOTE:**

**Text messages are only displayed if the vehicle speed is less than 5 mph (8 km/h).**

## PHONE SETTINGS

To access the phone settings:

1. Press the [APPS] button.
2. Touch the “Settings” key.
3. Touch the “Phone & Bluetooth” key.
4. Touch the “Phone Settings” key and adjust the following settings as desired:
  - Sort Phonebook By:  
Touch “First Name” or “Last Name” to choose how phonebook entries are alphabetically displayed on the screen.
  - Use Phonebook From:  
Touch “Handset” to use the phone’s phonebook. Select “SIM” to use the phonebook on the SIM card. Select “Both” to use both sources.
  - Download Phonebook Now:  
Touch to download the phonebook to the vehicle from the chosen source.
  - Record Name for Phonebook Entry:  
Touch to record a name for a phonebook entry for use with the NISSAN Voice Recognition System.

- Phone Notifications for:  
Touch “Driver” to have phone notifications shown in the vehicle information display. Select “Both” to have phone notifications shown in both the vehicle information display and the center display screen.
- Text Messaging:  
Touch to toggle the text message functionality on or off.
- Show Incoming Text for:  
Touch “Driver” to have incoming text notifications shown in the vehicle information display. Select “Both” to have text notifications shown in both the vehicle information display and the center display screen. Select “Off” to turn off all text notifications.
- Auto Reply:  
Touch to toggle the auto reply functionality on or off.
- Auto Reply Message:  
Touch to indicate preferred message to be sent when “Auto Reply” function is activated.
- Use Vehicle’s Signature:  
Touch to toggle on or off the addition of the vehicle signature to outgoing messages.

- Custom Text Messages:  
Touch this option to select a custom message to edit. There are 4 customer message slots available.

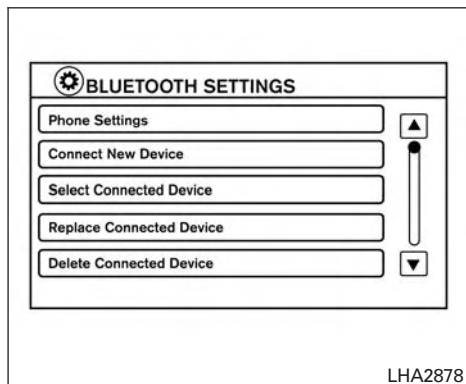

## BLUETOOTH® SETTINGS

To access the phone settings:

1. Press the [ APPS-□ ] button.
2. Touch the “Settings” key.
3. Touch the “Phone & Bluetooth” key.

Menu Item	Result
Phone Settings	See “Phone settings” in this section for more information.
Connect New Device	Touch to connect a new Bluetooth® device to the Bluetooth® Hands-Free Phone System.
Select Connected Device	Touch to choose a Bluetooth® device from a list of those devices connected to the Bluetooth® Hands-Free Phone System.
Replace Connected Device	Touch to replace a Bluetooth® device from a list of those devices connected to the Bluetooth® Hands-Free Phone System.
Delete Connected Device	Touch to delete a Bluetooth® device from a list of those devices connected to the Bluetooth® Hands-Free Phone System.
Bluetooth	Touch to toggle Bluetooth® on and off.

## NISSAN VOICE RECOGNITION SYSTEM (if so equipped)

The NISSAN Voice Recognition system allows hands-free operation of the systems equipped on this vehicle, such as the phone and navigation systems.

To operate NISSAN Voice Recognition, press the  button located on the steering wheel. When prompted, speak the command for the system you wish to activate. The command given is picked up by the microphone and performed when it is properly recognized. NISSAN Voice Recognition will provide a voice response as well as a message in the center display to inform you of the command results.

### USING THE SYSTEM

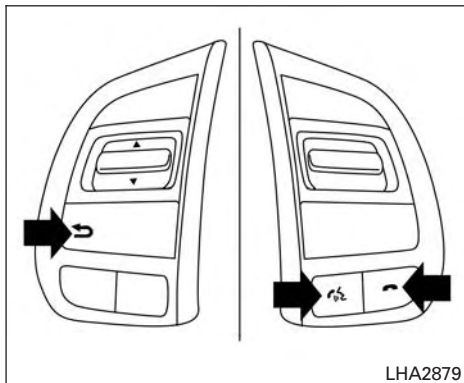

#### Initialization

When the ignition switch is in the ON position, NISSAN Voice Recognition is initialized, which takes a few seconds. When completed, the system is ready to accept voice commands. If the  button is pressed before the initialization completes, the system will announce: "Voice Recognition System not ready. Please wait."



#### Giving voice commands

1. Press the  button.
2. The system announces: "Please say a category like phone or a command like points of interest followed by a brand name". A list of available commands is then spoken by the system.
3. After the tone sounds and the face icon on the display changes, speak a command. Available commands are discussed later in this section.
4. Voice and display feedback are provided when the command is accepted.

- Press the  button to return to the previous screen.
- If the command is not recognized, the system announces provides a list of available selections.
- If you want to cancel the command or go back to the previous menu of commands, press the  button. The system will announce: "Cancelling voice recognition" or "Go back" depending on the current menu level.
- Press the  button to move back through the menus displayed on the screen.
- If you want to adjust the volume of the voice feedback, use the volume control switches on the steering wheel or the volume knob on the control panel.
- The voice command screen can also be accessed using the control panel display:
  1. Press the [ APPS ] button.
  2. Touch the "Voice Commands" key.

## Operating tips

To get the best performance out of NISSAN Voice Recognition, observe the following:

- Keep the interior of the vehicle as quiet as possible. Close the windows to eliminate the surrounding noises (traffic noises, vibration sounds, etc.), which may prevent the system from recognizing the voice commands correctly.
- Wait until a tone sounds before speaking a command. Otherwise, the command will not be received properly.
- Start speaking a command within 3.5 seconds after the tone sounds.
- Speak in a natural voice without pausing between words.

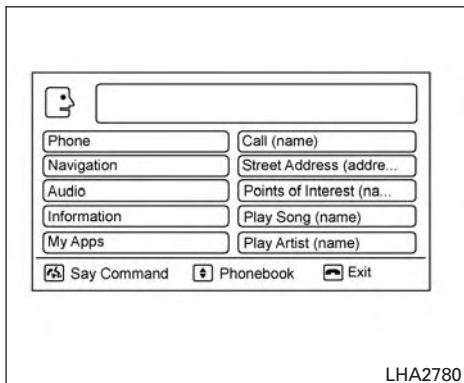

## SYSTEM FEATURES

NISSAN Voice Recognition can activate the following systems:

- Bluetooth™ Hands-Free Phone System
- Navigation
- Audio
- Information
- My Apps

For additional information on the navigation system, see the separate Navigation System Owner's Manual.

## How to say numbers

NISSAN Voice Recognition requires a certain way to speak numbers in voice commands. Refer to the following examples.

General rule: Either “zero” or “oh” can be used for “0”.

### Phone numbers

Speak phone numbers according to the following example. For 1-800-662-6200, say dial number and then speak the phone number in any of the following formats:

- “one eight oh oh six six two six two oh oh”
- “one eight hundred six six two six two oh oh”
- “one eight zero zero six six two six two oh oh”

For the best voice recognition phone dialing results, say phone numbers as single digits. Also, full numbers can only be spoken for “800”. For example, you cannot say 555-6000 as “five five five six thousand”.

## BLUETOOTH® HANDS-FREE PHONE SYSTEM VOICE COMMANDS

To access the Bluetooth® Hands-Free Phone System voice commands:

1. Press the  button.
2. Say "Call" and then a name in the vehicle phonebook to call that entry. Otherwise, say "Phone" to access various phone commands.

If the Bluetooth® has been set to "Off", the system announces: "Bluetooth® is off. Would you like to turn Bluetooth® on?"

If no phone is connected to the system and the vehicle is stationary, the system announces: "There is no phone connected. Would you like to connect a phone now?" Say "Yes" to connect a phone. All further Bluetooth® Hands-Free Phone System voice commands are only available if a phone is connected.

If a phone is connected and Bluetooth® is set to "On", the following voice commands are available:

- Call (a name)

Speak the name of the contact in which you are trying to call. System will confirm correct contact. Say "Dial" to initiate dialing.

- Dial Number

Allows for up to 24 digits to be dialed. After the number is entered, say "Dial" to initiate dialing. Say "Correction" to correct the number entered. Say "Go Back" to return to the main menu.

- List Phonebook

Starting with the first alphabetical entry in the vehicle phonebook, the system prompts for an additional command. Say "Dial" to call the number of the phonebook entry. Say "Send Text" to send a text message to the number of the phonebook entry. Say "Next Entry" to skip to the next alphabetical entry in the vehicle phonebook, where the same options will then be available.

- Recent Calls

The system prompts for an additional command. Say "Missed Calls", "Incoming Calls" or "Outgoing Calls" to display a list of such calls on the screen.

Speak the number of the entry displayed on the screen to dial that number or say "Next Page" to view entries on the next page (if available).

- Redial

Redials the last called number.

- Read Text

Reads an incoming text message. For more information about text messaging with the Bluetooth® Hands-Free Phone System, see "Bluetooth® Hands-Free Phone System with Navigation System" in this section.

- Send Text

Sends a text message. For more information about text messaging with the Bluetooth® Hands-Free Phone System, see "Bluetooth® Hands-Free Phone System with Navigation System" in this section.

- Select Phone

The system replies "Please use manual controls to continue". Use manual controls to change the active phone from among the listed phones connected to the vehicle.

For more information about the Bluetooth® Hands-Free Phone System, see "Bluetooth® Hands-Free Phone System with Navigation System" in this section.

## NAVIGATION SYSTEM VOICE COMMANDS

The following voice commands are available for the Navigation System:

- Street Address (address)
- Points of Interest (name)
- POI by Category
- Home
- Address Book
- Previous Destinations
- Enter Address in Steps
- Cancel Route

For more information about these commands, see the separate Navigation System Owner's Manual.

## AUDIO SYSTEM VOICE COMMANDS

To access the audio system voice commands:

1. Press the  button.
2. Say "Audio"
3. Speak a command from the following available commands:

- Play (AM, FM, etc.)  
Allows user to select radio band
- Tune AM (number)  
Allows user to tune directly to a desired AM frequency
- Tune FM (number)  
Allows user to tune directly to a desired FM frequency
- SXM channel (number)  
Allows user to tune directly to a desired SXM station (if so equipped)
- CD Track (number)  
Allows user to select track to be played
- Play Song (name)  
Allows user to select song name to be played
- Play Artist (name)  
Allows user to select artist to be played
- Play Album (name)  
Allows user to select album name to be played

For more information about the audio system, see "Audio system" in this section.

## INFORMATION VOICE COMMANDS

The following voice commands are available for the information functions of the Navigation System:

- Traffic
- Fuel Prices
- Stocks
- Movie Listings
- Current Weather
- Weather Map
- 5 — day Forecast
- 6 — hour Forecast

For more information about these commands, see the separate Navigation System Owner's Manual.

## MY APPS VOICE COMMANDS

Many Apps can be accessed using this voice command. See "NissanConnect™ App Smartphone Integration" in this section for more information.

## HELP VOICE COMMANDS

The following voice commands can be spoken to have the system provide instructions and tips for using the NISSAN Voice Recognition system.

- List Commands
- What Can I Say?
- General Help
- Quit
- Exit

## TROUBLESHOOTING GUIDE

The system should respond correctly to all voice commands without difficulty. If problems are encountered, follow the solutions given in this guide for the appropriate error. Where the solutions are listed by number, try each solution in turn, starting with number one, until the problem is resolved.

Symptom/error message	Solution
The system responds "Command Not Recognized" or the system fails to recognize the command correctly.	1. Ensure that the command format is valid. Use the "List Commands" or "What Can I Say?" command under the "Help" menu.
	2. Speak clearly without pausing between words and at a level appropriate to the ambient noise level.
	3. Ensure that the ambient noise level is not excessive (for example, with the windows open or the defroster on).
	<b>NOTE:</b> <b>If it is too noisy to use the phone, it is likely that voice commands will not be recognized.</b>
	4. If optional words of the command have been omitted, then the command should be tried with these in place.

**MEMO**



# 5 Starting and driving

Precautions when starting and driving.....	5-2	Driving the vehicle.....	5-15
Exhaust gas (carbon monoxide).....	5-2	Continuously Variable Transmission (CVT).....	5-15
Three-way catalyst.....	5-2	Parking brake.....	5-19
Tire Pressure Monitoring System (TPMS).....	5-3	Blind Spot Warning (BSW) System / Lane	
Avoiding collision and rollover.....	5-6	Departure Warning (LDW) System (if so equipped) ..	5-20
Off-road recovery.....	5-6	BSW system operation.....	5-21
Rapid air pressure loss.....	5-7	BSW driving situations.....	5-23
Drinking alcohol/drugs and driving.....	5-7	LDW system operation.....	5-25
Ignition switch (if so equipped).....	5-8	BSW/LDW temporary disabled status.....	5-26
Continuously Variable Transmission (CVT).....	5-8	BSW/LDW automatic deactivation.....	5-26
Key positions.....	5-9	BSW/LDW malfunction.....	5-27
NISSAN vehicle immobilizer system.....	5-9	Camera unit maintenance.....	5-27
Push-Button Ignition Switch (if so equipped).....	5-10	Cruise control (if so equipped).....	5-27
Operating range.....	5-11	Precautions on cruise control.....	5-27
Push-button ignition switch positions.....	5-11	Cruise control operations.....	5-28
Emergency engine shut off.....	5-12	Forward Collision Warning (FCW) system	
NISSAN Intelligent Key® battery discharge.....	5-12	(if so equipped).....	5-29
NISSAN vehicle immobilizer system.....	5-13	Approach warning.....	5-30
Before starting the engine.....	5-13	Precautions on FCW system.....	5-31
Starting the engine (models without NISSAN		FCW system operation.....	5-32
Intelligent Key® system).....	5-13	Sensor maintenance.....	5-33
Starting the engine (models with NISSAN		Break-in schedule.....	5-34
Intelligent Key® system).....	5-14	Fuel efficient driving tips.....	5-34

Increasing fuel economy.....	5-35	Hill descent control system (if so equipped) .....	5-44
Parking/parking on hills.....	5-36	Hill start assist system .....	5-45
Power steering.....	5-37	Cold weather driving.....	5-46
Brake system .....	5-37	Freeing a frozen door lock .....	5-46
Brake precautions .....	5-37	Anti-freeze.....	5-46
Anti-lock Braking System (ABS).....	5-38	Battery .....	5-46
Brake assist .....	5-39	Draining of coolant water.....	5-46
Vehicle Dynamic Control (VDC) system .....	5-39	Tire equipment .....	5-46
Chassis Control .....	5-41	Special winter equipment.....	5-47
Active trace control .....	5-41	Driving on snow or ice .....	5-47
Active engine brake.....	5-42	Engine block heater (if so equipped)	
Active ride control .....	5-43	(Canada only).....	5-47



## PRECAUTIONS WHEN STARTING AND DRIVING

### WARNING

- Do not leave children or adults who would normally require the assistance of others alone in your vehicle. Pets should also not be left alone. They could accidentally injure themselves or others through inadvertent operation of the vehicle. Also, on hot, sunny days, temperatures in a closed vehicle could quickly become high enough to cause severe or possibly fatal injuries to people or animals.
- Properly secure all cargo with ropes or straps to help prevent it from sliding or shifting. Do not place cargo higher than the seatbacks. In a sudden stop or collision, unsecured cargo could cause personal injury.
- To avoid raising the center of gravity excessively, do not exceed the rated capacity of the roof rack (if so equipped) and evenly distribute the load.

## EXHAUST GAS (carbon monoxide)

### WARNING

- Do not breathe exhaust gases; they contain colorless and odorless carbon monoxide. Carbon monoxide is dangerous. It can cause unconsciousness or death.
- If you suspect that exhaust fumes are entering the vehicle, drive with all windows fully open, and have the vehicle inspected immediately.
- Do not run the engine in closed spaces such as a garage.
- Do not park the vehicle with the engine running for any extended length of time.
- Keep the rear vent windows, liftgates, doors and trunk lids (if so equipped) closed while driving, otherwise exhaust gases could be drawn into the passenger compartment. If you must drive with one of these open, follow these precautions:
  1. Open all the windows.
  2. Set the  air recirculation button to off and the fan control dial to high to circulate the air.

- If electrical wiring or other cable connections must pass to a trailer through the seal on the lift gate or the body, follow the manufacturer's recommendation to prevent carbon monoxide entry into the vehicle.
- The exhaust system and body should be inspected by a qualified mechanic whenever:
  - a. The vehicle is raised for service.
  - b. You suspect that exhaust fumes are entering into the passenger compartment.
  - c. You notice a change in the sound of the exhaust system.
  - d. You have had an accident involving damage to the exhaust system, underbody, or rear of the vehicle.

## THREE-WAY CATALYST

The three-way catalyst is an emission control device installed in the exhaust system. Exhaust gases in the three-way catalyst are burned at high temperatures to help reduce pollutants.

### WARNING

- The exhaust gas and the exhaust system are very hot. Keep people, animals or flammable materials away from the exhaust system components.
- Do not stop or park the vehicle over flammable materials such as dry grass, waste paper or rags. They may ignite and cause a fire.

### CAUTION

- Do not use leaded gasoline. Deposits from leaded gasoline will seriously reduce the three-way catalyst's ability to help reduce exhaust pollutants.
- Keep your engine tuned up. Malfunctions in the ignition, fuel injection, or electrical systems can cause overrich fuel flow into the three-way catalyst, causing it to overheat. Do not keep driving if the engine misfires, or if noticeable loss of performance or other unusual operating conditions are detected. Have the vehicle inspected promptly by a NISSAN dealer.

- **Avoid driving with an extremely low fuel level. Running out of fuel could cause the engine to misfire, damaging the three-way catalyst.**
- **Do not race the engine while warming it up.**
- **Do not push or tow your vehicle to start the engine.**

## TIRE PRESSURE MONITORING SYSTEM (TPMS)

Each tire, including the spare (if provided), should be checked monthly when cold and inflated to the inflation pressure recommended by the vehicle manufacturer on the vehicle placard or tire inflation pressure label. (If your vehicle has tires of a different size than the size indicated on the vehicle placard or tire inflation pressure label, you should determine the proper tire inflation pressure for those tires.)

As an added safety feature, your vehicle has been equipped with a Tire Pressure Monitoring System (TPMS) that illuminates a low tire pressure telltale when one or more of your tires is significantly under-inflated. Accordingly, when the low tire pressure telltale illuminates, you should stop and check your tires as soon as possible, and inflate them to the proper pressure. Driving on a significantly under-inflated tire causes the tire to over-

heat and can lead to tire failure. Under-inflation also reduces fuel efficiency and tire tread life, and may affect the vehicle's handling and stopping ability.

Please note that the TPMS is not a substitute for proper tire maintenance, and it is the driver's responsibility to maintain correct tire pressure, even if under-inflation has not reached the level to trigger illumination of the TPMS low tire pressure telltale.

Your vehicle has also been equipped with a TPMS malfunction indicator to indicate when the system is not operating properly. The TPMS malfunction indicator is combined with the low tire pressure telltale. When the system detects a malfunction, the telltale will flash for approximately one minute and then remain continuously illuminated. This sequence will continue upon subsequent vehicle start-ups as long as the malfunction exists. When the malfunction indicator is illuminated, the system may not be able to detect or signal low tire pressure as intended. TPMS malfunctions may occur for a variety of reasons, including the installation of replacement or alternate tires or wheels on the vehicle that prevent the TPMS from functioning properly. Always check the TPMS malfunction telltale after replacing one or more tires or wheels on your vehicle to

ensure that the replacement or alternate tires and wheels allow the TPMS to continue to function properly.

#### **Additional information:**

- **The TPMS does not monitor the tire pressure of the spare tire.**
- The TPMS will activate only when the vehicle is driven at speeds above 16 MPH (25 km/h). Also, this system may not detect a sudden drop in tire pressure (for example a flat tire while driving).
- The low tire pressure warning light does not automatically turn off when the tire pressure is adjusted. After the tire is inflated to the recommended pressure, the vehicle must be driven at speeds above 16 MPH (25 km/h) to activate the TPMS and turn off the low tire pressure warning light. Use a tire pressure gauge to check the tire pressure.
- The “Tire Pressure Low Add Air” warning appears in the vehicle information display when the low tire pressure warning light is illuminated and low tire pressure is detected. The “Tire Pressure Low Add Air” warning turns off when the low tire pressure warning light turns off.

- The “Tire Pressure Low Add Air” warning does not appear if the low tire pressure warning light illuminates to indicate a TPMS malfunction.
- Tire pressure rises and falls depending on the heat caused by the vehicle’s operation and the outside temperature. Low outside temperature can lower the temperature of the air inside the tire which can cause a lower tire inflation pressure. This may cause the low tire pressure warning light to illuminate. If the warning light illuminates, check the tire pressure for all 4 tires.
- The Tire and Loading Information label (also referred to as the vehicle placard or tire inflation pressure label) is located in the driver’s door opening.
- You can also check the pressure of all tires (except the spare tire) on the vehicle information display screen. The order of the tire pressure figures displayed on the screen corresponds with the actual order of the tire position.

For additional information, see “Low tire pressure warning light” in the “Instruments and controls” section, “Tire Pressure Monitoring System (TPMS)” in the “In case of emergency” section.

#### **WARNING**

- **Radio waves could adversely affect electric medical equipment. Those who use a pacemaker should contact the electric medical equipment manufacturer for the possible influences before use.**
- **If the low tire pressure warning light illuminates while driving, avoid sudden steering maneuvers or abrupt braking, reduce vehicle speed, pull off the road to a safe location and stop the vehicle as soon as possible. Driving with under-inflated tires may permanently damage the tires and increase the likelihood of tire failure. Serious vehicle damage could occur and may lead to an accident and could result in serious personal injury. Check the tire pressure for all four tires. Adjust the tire pressure to the recommended COLD tire pressure shown on the Tire and Loading Information label to turn the low tire pressure warning light OFF. If you have a flat tire, replace it with a spare tire as soon as possible. (See “Flat tire” in the “In case of emergency” section for changing a flat tire.)**

- **When a spare tire is mounted or a wheel is replaced, tire pressure will not be indicated, the TPMS will not function and the low tire pressure warning light will flash for approximately 1 minute. The light will remain on after 1 minute. Contact your NISSAN dealer as soon as possible for tire replacement and/or system resetting.**
- **Replacing tires with those not originally specified by NISSAN could affect the proper operation of the TPMS.**
- **Do not inject any tire liquid or aerosol tire sealant into the tires, as this may cause a malfunction of the tire pressure sensors.**

### CAUTION

- **The TPMS may not function properly when the wheels are equipped with tire chains or the wheels are buried in snow.**
- **Do not place metalized film or any metal parts (antenna, etc.) on the windows. This may cause poor reception of the signals from the tire pressure sensors, and the TPMS will not function properly.**

Some devices and transmitters may temporarily interfere with the operation of the TPMS and cause the low tire pressure warning light to illuminate.

Some examples are:

- Facilities or electric devices using similar radio frequencies are near the vehicle.
- If a transmitter set to similar frequencies is being used in or near the vehicle.
- If a computer (or similar equipment) or a DC/AC converter is being used in or near the vehicle.

### **FCC Notice:**

#### **For USA:**

**This device complies with Part 15 of the FCC Rules. Operation is subject to the following two conditions: (1) This device may not cause harmful interference, and (2) this device must accept any interference received, including interference that may cause undesired operation.**

### **NOTE:**

**Changes or modification not expressly approved by the party responsible for compliance could void the user's authority to operate the equipment.**

### **For Canada:**

**This device complies with Industry Canada license-exempt RSS standard(s). Operation is subject to the following two conditions: (1) this device may not cause interference, and (2) this device must accept any interference, include interference that may cause undesired operation of the device.**

### **TPMS with Easy Fill Tire Alert**

When adding air to an under-inflated tire, the TPMS with Easy Fill Tire Alert provides visual and audible signals outside the vehicle to help you inflate the tires to the recommended COLD tire pressure.

### **Vehicle set-up:**

1. Park the vehicle in a safe and level place.
2. Apply the parking brake and place the shift lever to the P (Park) position.
3. Place the ignition switch to the ON position. Do not start the engine.

### **Operation:**

1. Add air to the tire.
2. After a few seconds, the hazard indicators will start flashing.

3. When the designated pressure is reached, the horn beeps once and the hazard indicators stop flashing.
4. Perform the above steps for each tire.
  - If the tire is over-inflated more than approximately 4 psi (30 kPa), the horn beeps and the hazard indicators flash 3 times. To correct the pressure, push the core of the valve stem on the tire briefly to release pressure. When the pressure reaches the designated pressure, the horn beeps once.
  - If the hazard indicator does not flash within approximately 15 seconds after starting to inflate the tire, it indicates that the Easy Fill Tire Alert is not operating.
  - The TPMS will not activate the Easy Fill Tire Alert under the following conditions:
    - If there is interference from an external device or transmitter.
    - The air pressure from the inflation device is not sufficient to inflate the tire.
    - There is a malfunction in the TPMS system.
    - There is a malfunction in the horn or hazard indicators.
  - The identification code of the tires pressure sensor is not registered to the system.
  - The battery of the tire pressure sensor is low.
  - If the Easy Fill Tire Alert does not operate due to TPMS interference, move the vehicle about 3 ft (1 m) backward or forward and try again.

If the Easy Fill Tire Alert is not working, use a tire pressure gauge.

## AVOIDING COLLISION AND ROLLOVER

### WARNING

**Failure to operate this vehicle in a safe and prudent manner may result in loss of control or an accident.**

Be alert and drive defensively at all times. Obey all traffic regulations. Avoid excessive speed, high speed cornering, or sudden steering maneuvers, because these driving practices could cause you to lose control of your vehicle. **As with any vehicle, loss of control could result in a collision with other vehicles or objects or cause the vehicle to roll over, particularly if the loss of control causes the vehicle to**

**slide sideways.** Be attentive at all times, and avoid driving when tired. Never drive when under the influence of alcohol or drugs (including prescription or over-the-counter drugs which may cause drowsiness). Always wear your seat belt as outlined in the “Safety – Seats, seat belts and supplemental restraint system” section of this manual, and also instruct your passengers to do so.

Seat belts help reduce the risk of injury in collisions and rollovers. **In a rollover crash, an unbelted or improperly belted person is significantly more likely to be injured or killed than a person properly wearing a seat belt.**

## OFF-ROAD RECOVERY

If the right side or left side wheels unintentionally leave the road surface, maintain control of the vehicle by following the procedure below. Please note that this procedure is only a general guide. The vehicle must be driven as appropriate based on the conditions of the vehicle, road and traffic.

1. Remain calm and do not overreact.
2. Do not apply the brakes.
3. Maintain a firm grip on the steering wheel with both hands and try to hold a straight course.

4. When appropriate, slowly release the accelerator pedal to gradually slow the vehicle.
  5. If there is nothing in the way, steer the vehicle to follow the road while vehicle speed is reduced. Do not attempt to drive the vehicle back onto the road surface until vehicle speed is reduced.
  6. When it is safe to do so, gradually turn the steering wheel until both tires return to the road surface. When all tires are on the road surface, steer the vehicle to stay in the appropriate driving lane.
- If you decide that it is not safe to return the vehicle to the road surface based on vehicle, road or traffic conditions, gradually slow the vehicle to a stop in a safe place off the road.

## RAPID AIR PRESSURE LOSS

Rapid air pressure loss or a “blow-out” can occur if the tire is punctured or is damaged due to hitting a curb or pothole. Rapid air pressure loss can also be caused by driving on under-inflated tires.

Rapid air pressure loss can affect the handling and stability of the vehicle, especially at highway speeds.

Help prevent rapid air pressure loss by maintaining the correct air pressure and visually inspect the tires for wear and damage. See “Wheels and tires” in the “Maintenance and do-it-yourself” section of this manual. If a tire rapidly loses air pressure or “blows-out” while driving, maintain control of the vehicle by following the procedure below. Please note that this procedure is only a general guide. The vehicle must be driven as appropriate based on the conditions of the vehicle, road and traffic.

### WARNING

**The following actions can increase the chance of losing control of the vehicle if there is a sudden loss of tire air pressure. Losing control of the vehicle may cause a collision and result in personal injury.**

- **The vehicle generally moves or pulls in the direction of the flat tire.**
- **Do not rapidly apply the brakes.**
- **Do not rapidly release the accelerator pedal.**
- **Do not rapidly turn the steering wheel.**

1. Remain calm and do not overreact.

2. Maintain a firm grip on the steering wheel with both hands and try to hold a straight course.
3. When appropriate, slowly release the accelerator pedal to gradually slow the vehicle.
4. Gradually steer the vehicle to a safe location off the road and away from traffic if possible.
5. Lightly apply the brake pedal to gradually stop the vehicle.
6. Turn on the hazard warning flashers and either contact a roadside emergency service to change the tire or see “Changing a flat tire” in the “In case of emergency” section of this manual.

## DRINKING ALCOHOL/DRUGS AND DRIVING

### WARNING

**Never drive under the influence of alcohol or drugs. Alcohol in the bloodstream reduces coordination, delays reaction time and impairs judgement. Driving after drinking alcohol increases the likelihood of being involved in an accident injuring yourself and others. Additionally, if you are injured in an accident, alcohol can increase the severity of the injury.**



## IGNITION SWITCH (if so equipped)

NISSAN is committed to safe driving. However, you must choose not to drive under the influence of alcohol. Every year thousands of people are injured or killed in alcohol-related accidents. Although the local laws vary on what is considered to be legally intoxicated, the fact is that alcohol affects all people differently and most people underestimate the effects of alcohol.

Remember, drinking and driving don't mix! That is true for drugs, too (over-the-counter, prescription, and illegal drugs). Don't drive if your ability to operate your vehicle is impaired by alcohol, drugs, or some other physical condition.

### WARNING

- **Never remove or turn the key to the LOCK position while driving. The steering wheel will lock (for models with a steering lock mechanism). This may cause the driver to lose control of the vehicle and could result in serious vehicle damage or personal injury.**
- **Never place the ignition switch in the LOCK position while driving. The steering wheel will lock (for models with a steering lock mechanism). This may cause the driver to lose control of the vehicle and could result in serious vehicle damage or personal injury.**

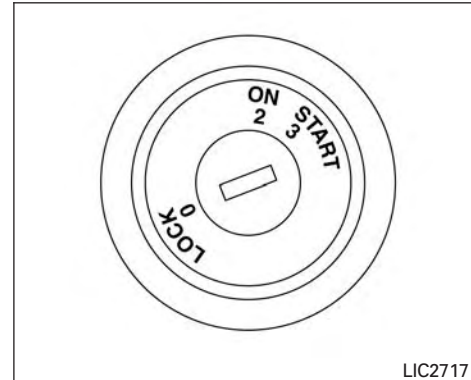

## CONTINUOUSLY VARIABLE TRANSMISSION (CVT)

The ignition lock is designed so that the ignition switch cannot be turned to the LOCK position until the shift lever is moved to the P (Park) position.

- When moving the ignition switch to the LOCK position, make sure the shift lever is in the P (Park) position.
- When removing the key from the ignition switch, make sure the shift lever is in the P (Park) position.

When the ignition switch cannot be turned to the LOCK position:

1. Shift the shift lever to the P (Park) position.
2. Turn the ignition switch slightly in the ON direction.
3. Turn the ignition switch to the LOCK position.
4. Remove the key if it is inserted in the ignition switch.

If the ignition switch is turned to the LOCK position, the shift lever cannot be moved from the P (Park) position.

**The shift lever can be moved if the ignition switch is placed in the ON position and the foot brake pedal is depressed.**

**There is an OFF position between the LOCK and ACC positions. The OFF position is indicated by a "1" on the key cylinder.**

## KEY POSITIONS

LOCK: Normal parking position (0)

OFF: (Not used) (1)

ACC: (Accessories) (2)

This position activates electrical accessories such as the radio when the engine is not running.

ON: Normal operating position (3)

This position turns on the ignition system and the electrical accessories.

START: (4)

This position starts the engine. As soon as the engine has started, release the key. It automatically returns to the ON position.

## NISSAN VEHICLE IMMOBILIZER SYSTEM

The NISSAN Vehicle Immobilizer system will not allow the engine to start without the use of the registered key.

If the engine fails to start using a registered key (for example, when interference is caused by another registered key, an automated toll road device or automatic payment device on the key ring), restart the engine using the following procedure:

1. Leave the ignition switch in the ON position for approximately 5 seconds.
2. Place the ignition switch in the OFF or LOCK position, and wait approximately 10 seconds.

3. Repeat steps 1 and 2.

4. Restart the engine while holding the device (which may have caused the interference) separate from the registered key.

If the no start condition re-occurs, NISSAN recommends placing the registered key on a separate key ring to avoid interference from other devices.

## PUSH-BUTTON IGNITION SWITCH (if so equipped)

### WARNING

Do not operate the push-button ignition switch while driving the vehicle except in an emergency. (The engine will stop when the ignition switch is pushed 3 consecutive times in quick succession or the ignition switch is pushed and held for more than 2 seconds.) If the engine stops while the vehicle is being driven, this could lead to a crash and serious injury.

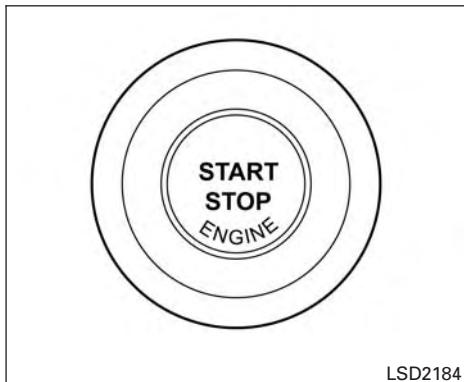

When the ignition switch is pushed without depressing the brake pedal, the ignition switch will illuminate.

Push the ignition switch center:

- once to change to ON.
- two times to change to OFF.

The ignition switch will automatically return to the LOCK position when any door is either opened or closed with the switch in the OFF position.

The ignition lock is designed so that the ignition switch position cannot be switched to OFF until the shift lever is moved to the P (Park) position.

When the ignition switch cannot be pushed toward the OFF position, proceed as follows:

1. Move the shift lever into the P (Park) position.
2. Push the ignition switch. The ignition switch position will change to the ON position.
3. Push the ignition switch again to the OFF position.

**The shift lever can be moved from the P (Park) position if the ignition switch is in the ON position and the brake pedal is depressed.**

**If the battery of the vehicle is discharged, the push-button ignition switch cannot be moved from the LOCK position.**

Some indicators and warnings for operation are displayed on the vehicle information display. See “Vehicle information display” in the “Instruments and controls” section of this manual.

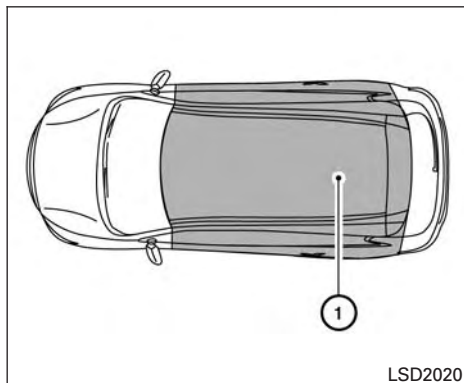

The operating range of the engine start function is inside of the vehicle ①.

- The luggage area is not included in the operating range, but the Intelligent Key may function.
- If the Intelligent Key is placed on the instrument panel, inside the glove box, storage bin or door pocket, the Intelligent Key may not function.
- If the Intelligent Key is placed near the door or window outside the vehicle, the Intelligent Key may function.

## PUSH-BUTTON IGNITION SWITCH POSITIONS

### LOCK (Normal parking position):

The ignition switch can only be locked in this position.

The ignition switch will lock when any door is opened or closed with the ignition switched off.

### ON (Normal operating position):

This position turns on the ignition system and electrical accessories.

ON has a battery saver feature that will turn the ignition switch to the OFF position, if the vehicle is not running, after some time under the following conditions:

- all doors are closed.
- shift lever is in P (Park).

The battery saver feature will be cancelled if any of the following occur:

- any door is opened.
- shift lever is moved out of the P (Park) position.
- ignition switch changes position.

### **CAUTION**

**Do not leave the vehicle with the ignition switch in the ON position when the engine is not running for an extended period. This can discharge the battery.**

### OFF:

The ignition switch is in the OFF position when the engine is turned off using the ignition switch. No lights will illuminate on the ignition switch.

## OPERATING RANGE

The Intelligent Key functions can only be used when the Intelligent Key is within the specified operating range.

When the Intelligent Key battery is almost discharged or strong radio waves are present near the operating location, the Intelligent Key system's operating range becomes narrower and may not function properly.

If the Intelligent Key is within the operating range, it is possible for anyone, even someone who does not carry the Intelligent Key, to push the ignition switch to start the engine.

## AUTO ACCESSORY:

With the vehicle in the P (Park) position, the Intelligent key with you and the ignition placed from ON to OFF, the radio can still be used for a period of time, or until the driver's door is opened.

After a period of time, functions such as radio, navigation, and Bluetooth® Hands-Free Phone System may be restarted by pressing the "POWER button/ VOLUME control knob" (See "Monitor, climate, audio, phone and voice recognition systems" in this manual) or the keyfob unlock button up to a total of 30 minutes.

## EMERGENCY ENGINE SHUT OFF

To shut off the engine in an emergency situation while driving, perform the following procedure:

- Rapidly push the push-button ignition switch 3 consecutive times in less than 1.5 seconds, or
- Push and hold the push-button ignition switch for more than 2 seconds.

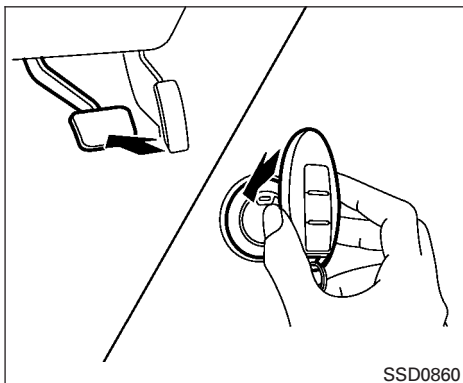

## NISSAN INTELLIGENT KEY® BATTERY DISCHARGE

If the battery of the NISSAN Intelligent Key® is discharged, or environmental conditions interfere with the Intelligent Key operation, start the engine according to the following procedure:

1. Place the shift lever in the P (Park) position.
2. Firmly apply the foot brake.
3. Touch the ignition switch with the Intelligent Key as illustrated. (A chime will sound.)

After step 3 is performed, when the ignition switch is pushed without depressing the brake pedal, the ignition switch position will change to ON.

4. Push the ignition switch while depressing the brake pedal within 10 seconds after the chime sounds. The engine will start.

## NOTE:

- When the ignition switch is pushed to the ON position or the engine is started by the above procedure, the Intelligent Key battery discharge indicator appears in the vehicle information display even when the Intelligent Key is inside the vehicle. This is not a malfunction. To turn off the Intelligent Key battery discharge indicator, touch the ignition switch with the Intelligent Key again.
- If the Intelligent Key battery discharge indicator appears, replace the battery as soon as possible. See "Battery Replacement" in the "Maintenance and do-it-yourself" section.

## NISSAN VEHICLE IMMOBILIZER SYSTEM

The NISSAN Vehicle Immobilizer system will not allow the engine to start without the use of the registered key.

If the engine fails to start using a registered key (for example, when interference is caused by another registered key, an automated toll road device or automatic payment device on the key ring), restart the engine using the following procedure:

1. Leave the ignition switch in the ON position for approximately 5 seconds.
2. Place the ignition switch in the OFF or LOCK position, and wait approximately 10 seconds.
3. Repeat steps 1 and 2.
4. Restart the engine while holding the device (which may have caused the interference) separate from the registered key.

If the no start condition re-occurs, NISSAN recommends placing the registered key on a separate key ring to avoid interference from other devices.

## BEFORE STARTING THE ENGINE

- Make sure the area around the vehicle is clear.
- Check fluid levels such as engine oil, coolant, brake fluid, and windshield-washer fluid as frequently as possible, or at least whenever you refuel.
- Check that all windows and lights are clean.
- Visually inspect tires for their appearance and condition. Also check tires for proper inflation.
- Check that all doors are closed.
- Position seat and adjust head restraints/headrests.
- Adjust inside and outside mirrors.
- Fasten seat belts and ask all passengers to do likewise.
- Check the operation of warning lights when the ignition switch is placed in the ON position. See "Warning/indicator lights and audible reminders" in the "Instruments and controls" section of this manual.

## STARTING THE ENGINE (models without NISSAN Intelligent Key® system)

1. Apply the parking brake.
2. Move the shift lever to P (Park) or N (Neutral). P (Park) is recommended.

**The shift lever cannot be moved out of P (Park) and into any of the other gear positions if the ignition key is turned to the OFF position or if the key is removed from the ignition switch.**

**The starter is designed not to operate if the shift lever is in any of the driving positions.**

3. Crank the engine **with your foot off the accelerator pedal** by turning the ignition key to START. Release the key when the engine starts. If the engine starts, but fails to run, repeat the above procedure.
  - If the engine is very hard to start in extremely cold weather or when restarting, depress the accelerator pedal a little (approximately 1/3 to the floor) and hold it and then crank the engine. Release the key and the accelerator pedal when the engine starts.

- If the engine is very hard to start because it is flooded, depress the accelerator pedal all the way to the floor and hold it. Crank the engine for 5-6 seconds. After cranking the engine, release the accelerator pedal. Crank the engine **with your foot off the accelerator pedal** by turning the ignition key to START. Release the key when the engine starts. If the engine starts, but fails to run, repeat the above procedure.

 **CAUTION**

**Do not operate the starter for more than 15 seconds at a time. If the engine does not start, turn the key off and wait 10 seconds before cranking again, otherwise the starter could be damaged.**

4. Allow the engine to idle for at least 30 seconds after starting. Do not race the engine while warming it up. Drive at moderate speed for a short distance first, especially in cold weather.

**NOTE:**

**Care should be taken to avoid situations that can lead to potential battery discharge and potential no-start conditions such as:**

- 1. Installation or extended use of electronic accessories that consume battery power when the engine is not running (Phone chargers, GPS, DVD players, etc.)**
- 2. Vehicle is not driven regularly and/or only driven short distances. In these cases, the battery may need to be charged to maintain battery health.**

## **STARTING THE ENGINE (models with NISSAN Intelligent Key® system)**

1. Apply the parking brake.
2. Move the shift lever to P (Park) or N (Neutral). P (Park) is recommended.

**The starter is designed not to operate if the shift lever is in any of the driving positions.**

3. Push the ignition switch to the ON position. Depress the brake pedal and push the ignition switch to start the engine.

To start the engine immediately, push and release the ignition switch while depressing the brake pedal with the ignition switch in any position.

- If the engine is very hard to start in extremely cold weather or when restarting, depress the accelerator pedal a little (approximately 1/3 to the floor) and while holding, crank the engine. Release the accelerator pedal when the engine starts.
- If the engine is very hard to start because it is flooded, depress the accelerator pedal all the way to the floor and hold it. Push the ignition switch to the ON position to start cranking the engine. After 5 or 6 seconds, stop cranking by pushing the ignition switch to LOCK. After cranking the engine, release the accelerator pedal. Crank the engine with your foot off the

accelerator pedal by depressing the brake pedal and pushing the push-button ignition switch to start the engine. If the engine starts, but fails to run, repeat the above procedure.

### CAUTION

**Do not operate the starter for more than 15 seconds at a time. If the engine does not start, push the ignition switch to the OFF position and wait 10 seconds before cranking again, otherwise the starter could be damaged.**

#### 4. Warm-up

Allow the engine to idle for at least 30 seconds after starting. Do not race the engine while warming it up. Drive at moderate speed for a short distance first, especially in cold weather. In cold weather, keep the engine running for a minimum of 2 - 3 minutes before shutting it off. Starting and stopping the engine over a short period of time may make the vehicle more difficult to start.

5. To stop the engine, shift the shift lever into the P (Park) position and push the ignition switch to the OFF position.

#### NOTE:

**Care should be taken to avoid situations that can lead to potential battery discharge and potential no-start conditions such as:**

1. Installation or extended use of electronic accessories that consume battery power when the engine is not running (Phone chargers, GPS, DVD players, etc.)
2. Vehicle is not driven regularly and/or only driven short distances. In these cases, the battery may need to be charged to maintain battery health.

## DRIVING THE VEHICLE

### CONTINUOUSLY VARIABLE TRANSMISSION (CVT)

The Continuously Variable Transmission (CVT) in your vehicle is electronically controlled to produce maximum power and smooth operation.

The recommended operating procedures for this transmission are shown on the following pages. Follow these procedures for maximum vehicle performance and driving enjoyment.

**Engine power may be automatically reduced to protect the CVT if the engine speed increases quickly when driving on slippery roads or while being tested on some dynamometers.**

#### Starting the vehicle

1. After starting the engine, fully depress the foot brake pedal before moving the shift lever out of the P (Park) position.

**This CVT is designed so that the foot brake pedal must be depressed before shifting from P (Park) to any driving position while the ignition switch is in the ON position.**

**The shift lever cannot be moved out of the P (Park) position and into any of the other positions if the ignition switch is placed in the LOCK, OFF or ACC (if equipped) position.**



2. Keep the foot brake pedal depressed and move the shift lever to a driving position.
3. Release the parking brake and foot brake pedal, and then gradually start the vehicle in motion.

### **⚠ WARNING**

- **Do not depress the accelerator pedal while shifting from P (Park) or N (Neutral) to R (Reverse), D (Drive) or L (Low) position. Always depress the brake pedal until shifting is completed. Failure to do so could cause you to lose control and have an accident.**
- **Cold engine idle speed is high, so use caution when shifting into a forward or reverse gear before the engine has warmed up.**
- **Never shift to P (Park) or R (Reverse) while vehicle is moving. Failure to do so could cause you to lose control and have an accident.**

### **⚠ CAUTION**

- **When stopping the vehicle on an uphill grade, do not hold the vehicle by depressing the accelerator pedal. The foot brake should be used for this purpose.**
- **Do not downshift abruptly on slippery roads. This may cause a loss of control.**
- **Except in an emergency, do not shift to the N (Neutral) position while driving. Coasting with the transmission in the N (Neutral) position may cause serious damage to the transmission.**

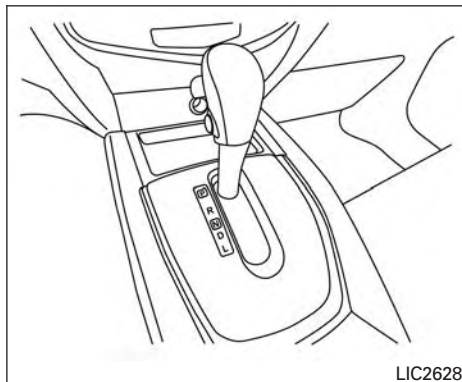

LIC2628

### Shifting

After starting the engine, fully depress the brake pedal, push and press the shift lever button and move the shift lever from the P (Park) position to any of the desired shift positions.

### **⚠ WARNING**

**Apply the parking brake if the shift lever is in any position while the engine is not running. Failure to do so could cause the vehicle to move unexpectedly or roll away and result in serious personal injury or property damage.**

**CAUTION**

Use the **P (Park)** or **R (Reverse)** position only when the vehicle is completely stopped.

**P (Park):**

**CAUTION**

To prevent transmission damage, use the **P (Park)** or **R (Reverse)** position only when the vehicle is completely stopped.

Use the **P (Park)** shift lever position when the vehicle is parked or when starting the engine. Make sure the vehicle is completely stopped. **The brake pedal must be depressed and the shift lever button pushed in to move the shift lever from N (Neutral) or any drive position to P (Park).** Apply the parking brake. When parking on a hill, apply the parking brake first, then move the shift lever into the **P (Park)** position.

**R (Reverse):**

**CAUTION**

To prevent transmission damage, use the **P (Park)** or **R (Reverse)** position only when the vehicle is completely stopped.

Use the **R (Reverse)** position to back up. Make sure the vehicle is completely stopped before selecting the **R (Reverse)** position. **The brake pedal must be depressed and the shift lever button pushed in to move the shift lever from P (Park), N (Neutral) or any drive position to R (Reverse).**

**N (Neutral):**

Neither forward nor reverse gear is engaged. The engine can be started in this position. You may shift to **N (Neutral)** and restart a stalled engine while the vehicle is moving.

**D (Drive):**

Use this position for all normal forward driving.

**L (Low):**

Use this position for engine braking on steep downhill gradients/climbing steep slopes and whenever approaching sharp bends. Do not use the **L (Low)** position in any other circumstances.

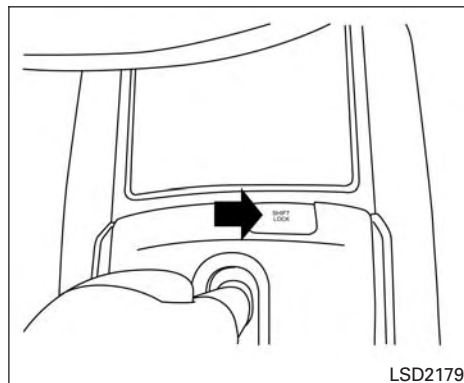

**Shift lock release**

If the battery charge is low or discharged, the shift lever may not be moved from the **P (Park)** position even with the brake pedal depressed and the shift lever button pushed. To move the shift lever, perform the following procedure:

1. Place the ignition switch in the **OFF** or **LOCK** position.
2. Apply the parking brake.
3. Remove the shift lock release cover using a suitable tool.
4. Push down the shift lock release using a suitable tool.

5. Press the shift lever button and move the shift lever to the N (Neutral) position while holding down the shift lock release. The vehicle may be moved to the desired location. Replace the removed shift lock release cover after the operation. If the shift lever cannot be moved out of the P (Park) position, have a NISSAN dealer check the CVT system as soon as possible.

### **WARNING**

**If the shift lever cannot be moved from the P (Park) position while the engine is running and the brake pedal is depressed, the stop lights may not work. Malfunctioning stop lights could cause an accident injuring yourself and others.**

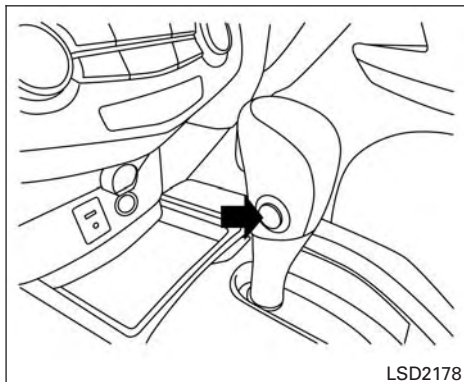

### Overdrive (O/D) OFF switch

When the O/D OFF switch is pushed with the shift lever in the D (Drive) position, the <sup>O/D</sup>OFF light in the instrument panel illuminates. See "Overdrive off indicator light" in the "Instruments and controls" section of this manual.

Use the Overdrive off mode when you need improved engine braking.

To turn off the Overdrive off mode, push the O/D OFF switch again. The <sup>O/D</sup>OFF indicator light will turn off.

Each time the engine is started, or when the shift lever is shifted to any position other than D (Drive), the Overdrive off mode will be automatically turned off.

### Accelerator downshift

— in D position —

For passing or hill climbing, depress the accelerator pedal to the floor. This shifts the transmission down into a lower gear, depending on the vehicle speed.

### High fluid temperature protection mode

This transmission has a high fluid temperature protection mode. If the fluid temperature becomes too high (for example, when climbing steep grades in high temperatures with heavy loads, such as when towing a trailer), engine power and, under some conditions, vehicle speed will be decreased automatically to reduce the chance of transmission damage. Vehicle speed can be controlled with the accelerator pedal, but the engine and vehicle speed may be limited.

## Fail-safe

If the vehicle is driven under extreme conditions, such as excessive wheel spinning and subsequent hard braking, the fail-safe system may be activated. The MIL may come on to indicate the fail-safe mode is activated, see “Malfunction Indicator Light (MIL)” in the “Instrument and controls” section. This will occur even if all electrical circuits are functioning properly. In this case, place the ignition switch in the OFF position and wait for 10 seconds. Then push the switch back to the ON position. The vehicle should return to its normal operating condition. If it does not return to its normal operating condition, have a NISSAN dealer check the transmission and repair if necessary.

### WARNING

When the high fluid temperature protection mode or fail-safe operation occurs, vehicle speed may be gradually reduced. The reduced speed may be lower than other traffic, which could increase the chance of a collision. Be especially careful when driving. If necessary, pull to the side of the road at a safe place and allow the transmission to return to normal operation, or have it repaired if necessary.

### WARNING

- Be sure the parking brake is fully released before driving. Failure to do so can cause brake failure and lead to an accident.
- Do not release the parking brake from outside the vehicle.
- Do not use the shift lever in place of the parking brake. When parking, be sure the parking brake is fully engaged.
- Do not leave children unattended in a vehicle. They could release the parking brake and cause an accident.

## PARKING BRAKE

## BLIND SPOT WARNING (BSW) SYSTEM / LANE DEPARTURE WARNING (LDW) SYSTEM (if so equipped)

The Blind Spot Warning (BSW) system helps alert the driver of other vehicles in adjacent lanes when changing lanes.

The Lane Departure Warning (LDW) system helps alert the driver when the vehicle is traveling close to either the left or the right of a traveling lane.

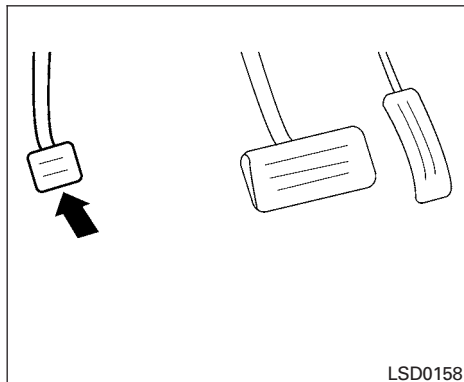

**To engage:** Firmly depress the parking brake.

### To release:

1. Firmly apply the foot brake.
2. Move the shift lever to the P (Park) position.
3. Firmly depress the parking brake pedal and it will release.
4. Before driving, be sure the brake warning light goes out.

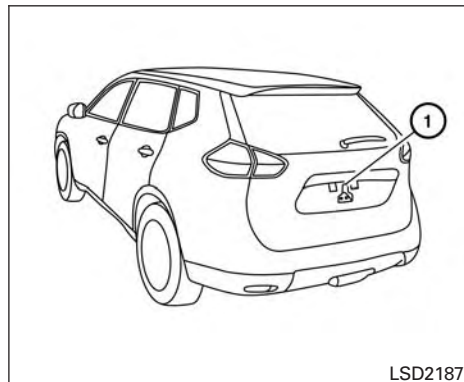

The BSW/LDW systems use the rear view monitor camera unit ① with automatic washer and blower.

### WARNING

- **The BSW system is not a replacement for proper driving procedure and is not designed to prevent contact with vehicles or objects. When changing lanes, always use the side and rear mirrors and turn and look in the direction you will move to ensure it is safe to change lanes. Never rely solely on the BSW system.**

- The LDW system is only a warning device to help inform the driver of a potential unintended lane departure. It will not steer the vehicle or prevent loss of control. It is the driver's responsibility to stay alert, drive safely, keep the vehicle in the traveling lane, and be in control of the vehicle at all times.
- The camera unit may not function properly under the following conditions:
  - When towing a trailer.
  - When strong light enters the camera unit. (e.g. light directly shines on the rear of the vehicle at sunrise or sunset.)
  - When ambient brightness changes suddenly. (e.g. when the vehicle enters or exits a tunnel or passes under a bridge.)
- If the camera lens is excessively dirty, the automatic washer may not be able to completely clean the lens. This could result in the camera not detecting vehicles or lane markers.
- Excessive noise (e.g. audio system volume, open vehicle window) will interfere with the chime sound, and it may not be heard.

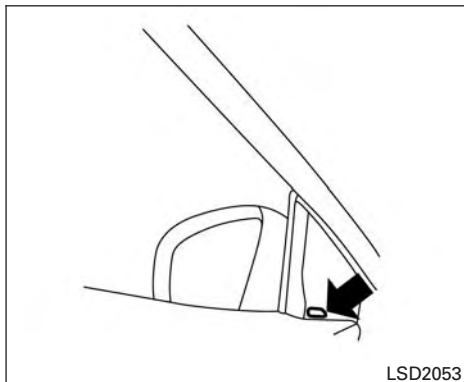

### BSW SYSTEM OPERATION

The BSW system operates above approximately 20 MPH (32 km/h).

When the camera unit detects vehicles in the detection zone, the Blind spot indicator light located inside the outside mirrors will illuminate. If the turn signal is then activated, the system chimes (twice) and the Blind spot indicator light flashes to alert the driver.

The Blind spot indicator light continues to flash until the detected vehicle(s) leave the detection zone.



Blind spot warning light

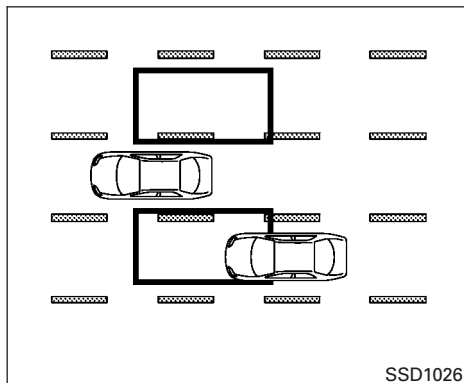

### Detection zone

The camera unit can detect vehicles on either side of your vehicle when part of another vehicle is within the detection zone shown as illustrated.

This detection zone typically starts from the outside mirror of your vehicle and extends approximately 10 ft (3.0 m) behind the rear bumper, and approximately 10 ft (3.0 m) sideways.

### NOTE:

**The Blind spot indicator light will illuminate for a few seconds when the ignition switch is placed in the ON position.**

The brightness of the Blind spot indicator lights is adjusted automatically depending on the brightness of the ambient light.

A chime sounds if the camera unit has already detected vehicles when the driver activates the turn signal. If a vehicle comes into the detection zone after the driver activates the turn signal, then only the Blind spot indicator light flashes and no chime sounds. (See “BSW driving situations” later in this section.)

### Turning on or off the BSW system



The BSW system is turned on or off using the settings menu in the vehicle information display.

### SYSTEM ON:

The BSW light on the instrument panel will light up.

### SYSTEM OFF:

The BSW light on the instrument panel will go out.

1. Press the  button until “Settings” displays in the vehicle information display. Use the  to select “Driver Assistance”. Then press the ENTER button.
2. Select “Driving Aids”, and press the ENTER button.
3. To set the BSW system to on or off, use the  buttons to navigate in the menu and use the ENTER button to select or change an item:
  - Select “Blind Spot” and press the ENTER button.
  - To turn on the warning, use the ENTER button to check box for “Warning (BSW)”

The warning systems switch is used to temporarily turn off the warning systems (Lane Departure Warning (LDW) and Blind Spot Warning (BSW) systems) that are activated using the settings menu in the vehicle information display. See “Warning systems switch” in “Instruments and controls.”

## **⚠ WARNING**

- The camera unit may not be able to detect when certain objects are present such as:
  - Pedestrians, bicycles, animals
  - Some types of small vehicles such as motorcycles, and very short length vehicles
  - Oncoming vehicles
  - A vehicle approaching rapidly from behind. (See “BSW driving situations” later in this section)
  - A vehicle which your vehicle overtakes rapidly. (See “BSW driving situations” later in this section)
  - A vehicle that merges or changes lanes rapidly directly next to your vehicle.
- The camera unit may not be able to detect property when your vehicle travels beside the middle section of a vehicle with long wheelbase (e.g. trailer truck, semi-trailer, tractor).

- The camera detection zone is designed based on a standard lane width. When driving in a wider lane, the camera unit may not detect vehicles in an adjacent lane. When driving in a narrow lane, the camera unit may detect vehicles driving two lanes away.
- The camera unit is designed to ignore most stationary objects, however objects such as guardrails, walls, foliage and parked vehicles may occasionally be detected. This is a normal operating condition.
- The camera unit may detect the reflected image of vehicles or roadside objects that are not actually in the detection zone, especially when the road is wet.

## **BSW DRIVING SITUATIONS**

Another vehicle approaching from behind

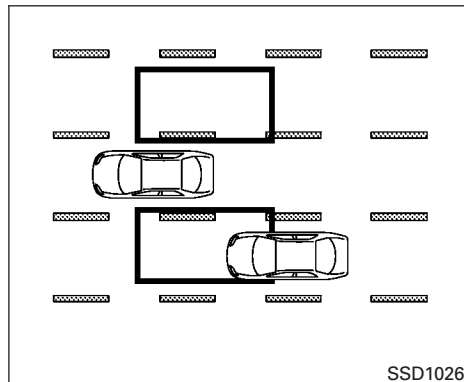

The Blind spot indicator light illuminates if a vehicle enters the detection zone from behind in an adjacent lane.

However, if the overtaking vehicle is traveling much faster than your vehicle, the indicator light may not illuminate before the detected vehicle is beside your vehicle. Always use the side and rear mirrors and turn and look in the direction your vehicle will move to ensure it is safe to change lanes.



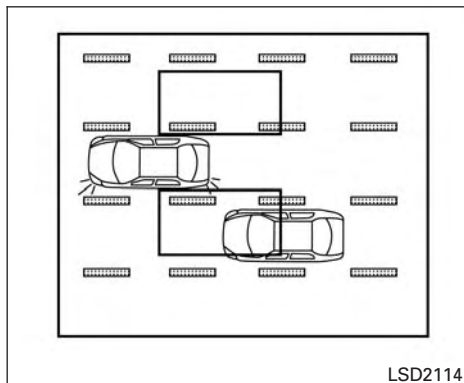

If the driver activates the turn signal, then the Blind Spot indicator light flashes and a chime will sound twice.

**NOTE:**

**If the driver activates the turn signal before a vehicle enters the detection zone, the Blind Spot indicator light will flash but no chime will sound when the other vehicle is detected.**

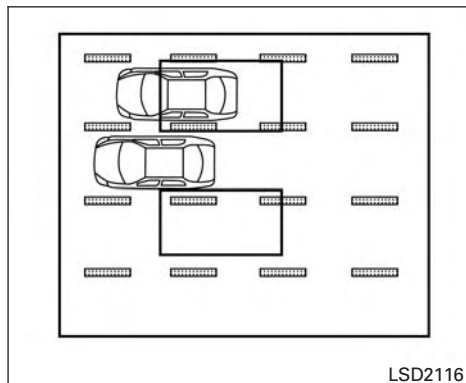

### Overtaking other vehicles

The Blind Spot indicator light illuminates if you overtake a vehicle and that vehicle stays in the detection zone for approximately 3 seconds.

The camera unit may not detect slower moving vehicles if they are passed quickly.

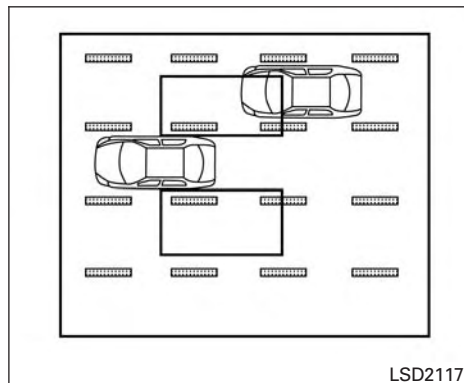

If the driver activates the turn signal while another vehicle is in the detection zone, then the Blind Spot indicator light flashes and a chime will sound twice.

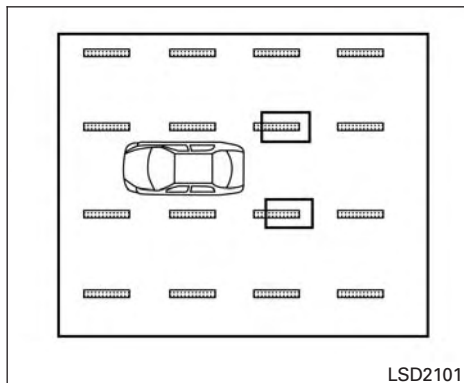

## LDW SYSTEM OPERATION

The LDW system operates above approximately 45 MPH (70 km/h).

When the vehicle approaches either the left or the right of the traveling lane, the LDW system will chime a sound and the LDW light on the instrument panel will blink to alert the driver

The LDW system is not designed to operate under the following conditions



### Lane departure warning light

- When you operate the lane change signal and change traveling lanes in the direction of the signal. (The LDW system will become operable again approximately 2 seconds after the lane change signal is turned off.)
- When the vehicle speed is less than approximately 45 MPH (70 km/h).

### Turning on or off the LDW system



The LDW system is turned on or off using the settings menu in the vehicle information display.

### SYSTEM ON:

The LDW light on the instrument panel will light up.

### SYSTEM OFF:

The LDW light on the instrument panel will go out.

1. Press the  button until "Settings" displays in the vehicle information display. Use the  to select "Driver Assistance". Then press the ENTER button.
2. Select "Driving Aids", and press the ENTER button.
3. To set the LDW system to on or off, use the  buttons to navigate in the menu and use the ENTER button to select or change an item:
  - Select "Lane" and press the ENTER button.
  - To turn on the warning, use the ENTER button to check box for "Warning (LDW)"

The warning systems switch is used to temporarily turn off the warning systems (Lane Departure Warning (LDW) and Blind Spot Warning (BSW) systems) that are activated using the settings menu in the vehicle information display. See “Warning systems switch” in “Instruments and controls.”

### WARNING

- **The camera unit may not be able to detect properly under the following conditions:**
  - **On roads where there are multiple parallel lane markers; lane markers that are faded or not painted clearly; yellow painted lane markers; non-standard lane markers; or lane markers covered with water, dirt, snow, etc.**
  - **On roads where the discontinued lane markers are still detectable.**
  - **On roads where there are sharp curves.**

- **On roads where there are sharply contrasting objects, such as shadows, snow, water, wheel ruts, seams or lines remaining after road repairs. (The LDW system could detect these items as lane markers.)**
- **On roads where the traveling lane merges or separates.**
- **When the vehicle’s traveling direction does not align with the lane marker.**
- **When the road surface is very dark due to weak ambient light or impaired tail lamp.**
- **When driving on a curved road, warning will be late on the outside of the curve.**

## BSW/LDW TEMPORARY DISABLED STATUS

Under the following condition, the BSW and/or LDW system is turned off temporarily, the BSW light (white) and/or LDW light (orange) will blink, and either of the following message will appear in the vehicle information display:

- “Trunk is open”
- “Washer fluid is low”

When the above conditions are corrected, the BSW and/or LDW system will resume automatically.

## BSW/LDW AUTOMATIC DEACTIVATION

When dirt, rain or snow cannot be removed by the automatic washer and blower and accumulates on the camera, making it impossible to detect the vehicles or the lane markers, the BSW and/or LDW system will be turned off automatically. The BSW light (white) and/or LDW light (orange) will blink, and the “Unavailable : Clean rear camera” will appear in the vehicle information display.

Action to take:

If the message appears, park the vehicle in a safe place, clean the camera unit with a soft cloth. Then turn off and restart the engine.

## BSW/LDW MALFUNCTION

When the BSW and/or LDW system malfunctions, they will be turned off automatically, the BSW light (white) and/or LDW light (orange) will illuminate and "Malfunction: Please see owners manual" will appear in the vehicle information display.

Action to take:

Stop the vehicle in a safe location, turn off and restart the engine. If the BSW light (white) and/or the LDW light (orange) continues to illuminate, have the BSW and/or LDW system checked by a NISSAN dealer.

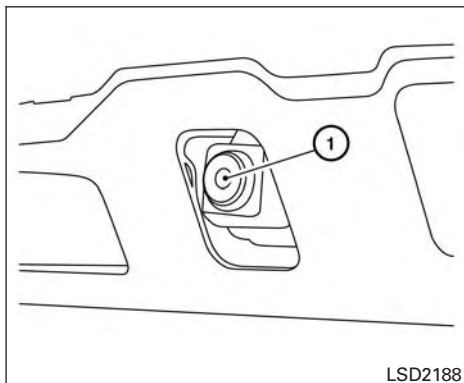

## CAMERA UNIT MAINTENANCE

The rear camera unit ① for the LDW/BSW systems is located above the rear licence plate. To maintain the proper operation of the LDW/BSW systems and help keep the system functioning, be sure to observe the following:

- Always keep the camera unit clean.
- Do not attach "licence plate accessories" that reflect light.
- Do not strike or damage the areas around the camera unit.

## CRUISE CONTROL (if so equipped)

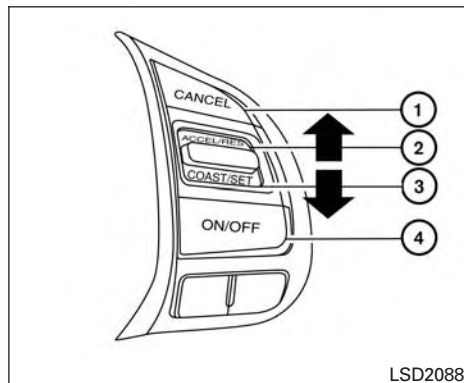

1. CANCEL switch
2. ACCEL/RES switch
3. COAST/SET switch
4. ON/OFF switch

## PRECAUTIONS ON CRUISE CONTROL

- If the cruise control system malfunctions, it cancels automatically. The CRUISE indicator light in the vehicle information display then blinks to warn the driver.
- If the CRUISE indicator light blinks, turn the cruise control switch off and have the system checked by a NISSAN dealer.

- The CRUISE indicator light may blink when the cruise control switch is turned ON while pushing the ACCEL/RES, COAST/SET, or CANCEL switch. To properly set the cruise control system, use the following procedures.

### WARNING

**Do not use the cruise control when driving under the following conditions:**

- **When it is not possible to keep the vehicle at a set speed.**
- **In heavy traffic or in traffic that varies in speed.**
- **On winding or hilly roads.**
- **On slippery roads (rain, snow, ice, etc.).**
- **In very windy areas.**

**Doing so could cause a loss of vehicle control and result in an accident.**

## CRUISE CONTROL OPERATIONS

The cruise control allows driving at a speed between 25 - 89 MPH (40 - 144 km/h) without keeping your foot on the accelerator pedal.

**To turn on the cruise control**, push the ON-OFF switch on. The CRUISE indicator light in the vehicle information display will illuminate.

**To set cruising speed**, accelerate the vehicle to the desired speed, push the COAST/SET switch and release it. Take your foot off the accelerator pedal. Your vehicle maintains the set speed.

- **To pass another vehicle**, depress the accelerator pedal. When you release the pedal, the vehicle returns to the previously set speed.
- The vehicle may not maintain the set speed when going up or down steep hills. If this happens, drive without the cruise control.

**To cancel the preset speed**, use one of the following three methods.

- Push the CANCEL button.
- Tap the brake pedal.
- Push the ON-OFF switch off. The CRUISE indicator light in the vehicle information display goes out.

The cruise control is automatically canceled if:

- you depress the brake pedal while pushing the ACCEL/RES or SET/COAST switch. The preset speed is deleted from memory.
- the vehicle slows down more than 8 MPH (13 km/h) below the set speed.
- you move the shift lever to N (Neutral).

**To reset at a faster cruising speed**, use one of the following three methods.

- Depress the accelerator pedal. When the vehicle attains the desired speed, push and release the COAST/SET switch.
- Push and hold the ACCEL/RES switch. When the vehicle attains the speed you desire, release the switch.
- Push and release the ACCEL/RES switch. Each time you do this, the set speed increases by about 1 MPH (1.6 km/h).

## FORWARD COLLISION WARNING (FCW) SYSTEM (if so equipped)

**To reset at a slower cruising speed,** use one of the following three methods.

- Lightly tap the brake pedal. When the vehicle attains the desired speed, push the COAST/SET switch and release it.
- Push and hold the COAST/SET switch. Release the switch when the vehicle slows to the desired speed.
- Push and release the COAST/SET switch. Each time you do this, the set speed decreases by about 1 MPH (1.6 km/h).

**To resume the preset speed,** push and release the ACCEL/RES switch. The vehicle returns to the last set cruising speed when the vehicle speed is over 25 MPH (40 km/h).

**To turn off the cruise control,** use one of the following three methods.

- Push the CANCEL button.
- Tap the brake pedal.
- Push the ON-OFF switch off. The CRUISE indicator light in the vehicle information display goes out.

The Forward Collision Warning (FCW) system will warn the driver by a warning light and chime when your vehicle is getting close to the vehicle ahead in the traveling lane.

The FCW system will function when your vehicle is driven at speeds of approximately 10 MPH (15 km/h) and above.

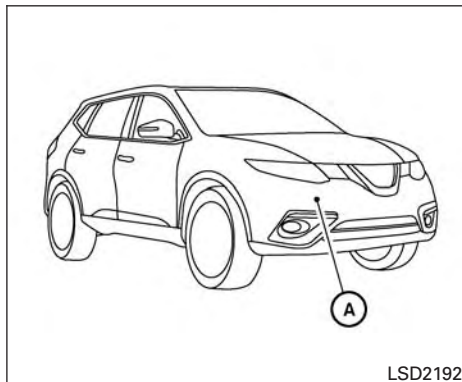

The FCW system uses the distance sensor (A) located behind the front bumper to measure the distance to the vehicle ahead. When the system judges that your vehicle is getting close to the vehicle ahead in the travel lane, FCW Indicator (orange) on the instrument panel blinks and a warning chime sounds.

The FCW system can be turned on/off by using the settings menu on the information display. See “How to enable/disable the FCW system” using the settings menu later in this section.



Vehicle ahead detection light  
APPROACH WARNING

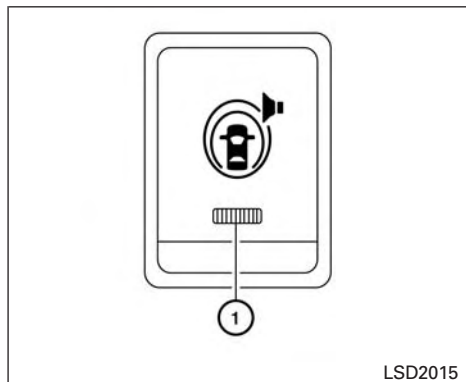

Warning systems switch

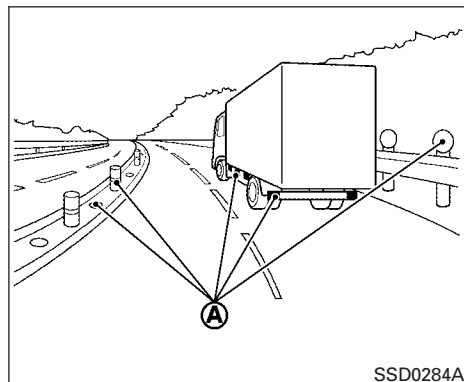

**NOTE:**

The warning chime may sound and the system display may blink when the distance sensor detects vehicles in other lanes (A) or objects on the side of the road (A). This may cause the FCW system to operate inappropriately. The distance sensor may detect these objects when the vehicle is driven on winding roads, narrow roads, hilly roads, or when entering or exiting a curve. In these cases you will have to manually control the proper distance ahead of your vehicle.

Also, the sensor sensitivity can be affected by vehicle operation (steering maneuver or driving position in the lane) or traffic or vehicle condition (for example, if a vehicle is being driven with some damage).

## PRECAUTIONS ON FCW SYSTEM

### WARNING

- The FCW system is intended to warn you before a collision occurs; it cannot prevent a collision. It is the driver's responsibility to stay alert, drive safely and be in control of the vehicle at all times.
- As there is a performance limit, the system may not provide a warning in certain conditions.
- The system will not detect the following objects:
  - Pedestrians, animals or obstacles in the roadway
  - Oncoming vehicles in the same lane
- The system will not detect another vehicle under the following conditions:
  - When the sensor area of the front bumper gets dirty and it is impossible to detect the distance from the vehicle ahead.

- When the sensor signal is temporarily interrupted
- The system may not function properly under the following conditions:
  - A preceding vehicle is with a large amount of ground clearance or protruding freight (including a small vehicle such as motorcycles).
  - When the sensor area of the front bumper gets dirty or it is impossible to detect the distance from the vehicle ahead.
  - When visibility is low (such as rain, fog, snow, etc.).
  - When snow or road spray from traveling vehicles is splashed.
  - When excessively heavy baggage is loaded in the rear seat or the luggage room of your vehicle.
  - When abruptly accelerating or decelerating.
  - On a steep downhill slope or on roads with sharp curves.

- When there is a highly reflective object near the vehicle ahead (for example, being very close to another vehicle, signboard, etc.)
- When you are towing a trailer.
- Depending on certain road conditions (curved or beginning of a curve), vehicle conditions (steering position or vehicle position), or the preceding vehicle's conditions (position in lane, etc.), the system may not function properly. The system may detect highly reflective objects such as guard rails, traffic signs and other stationary objects on the road or near the traveling lane and provide unnecessary warning.
- The system may not function in offset conditions.
- The system may not function when the distance to the vehicle ahead is extremely close.



- **The system is designed to automatically check the sensor's functionality. If the sensor area of the front bumper is covered with ice, a transparent or translucent bag, etc., the system may not detect them. In these instances, the system may not be able to warn the driver properly. Be sure to check and clean the sensor area of the front bumper regularly.**
- **Excessive noise will interfere with the warning chime sound, and the chime may not be heard.**
- **A sudden appearance of a vehicle in front (for example, it abruptly cuts in) may not be detected and the system may not warn the driver soon enough.**
- **The system will be cancelled automatically with a beep sound and a message will pop up under the following conditions:**
  - **When the sensor area of the front bumper is dirty**
  - **When the system malfunctions**

If the system cancels and a message appears with a beep sound, pull off the road to a safe location, stop the vehicle and turn the engine off.

Check to see if the sensor area of the front bumper is blocked. If the sensor area of the front bumper is blocked, remove the object blocking and restart the engine.

If the sensor is malfunctioning, have the system checked by a NISSAN dealer.

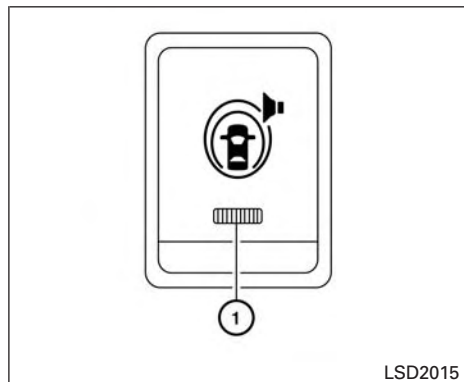

**Warning systems switch**

## FCW SYSTEM OPERATION

The FCW system is active at speeds of approximately 10 MPH (15 km/h) and above, when the system turns on.



When FCW is turned on, FCW Indicator (white) will turn on. FCW system is activated using the settings menu on the information display. See "How to enable/disable the FCW system" using the settings menu later in this section.



When the warning systems switch is turned off, the indicator ① on the switch is off. The indicator will also be off if the FCW, the Lane Departure Warning (LDW) and the Blind Spot Warning (BSW) systems are deactivated.

When the warning systems switch is pushed, the LDW and BSW system will also turn on or off simultaneously. See "Lane Departure Warning (LDW) system" and "Blind Spot Warning (BSW) system" in this section.

## How to enable/disable the FCW system

Perform the following steps to enable or disable the FCW system.

1. Press the  button until "Settings" displays in the vehicle information display. Use the  button to select "Driver Assistance". Then press the ENTER button.
2. Select "Driver Aids", and press the ENTER button.

3. To set FCW system to on or off, use the   buttons to navigate in the menu and use the ENTER button to select or change item:
  - To turn on the warning use the ENTER button to check box for "Forward."
  - To turn off the warning use the ENTER button to clear box for "Forward."
- The FCW light will illuminate on the Vehicle Information Display when the system is on.

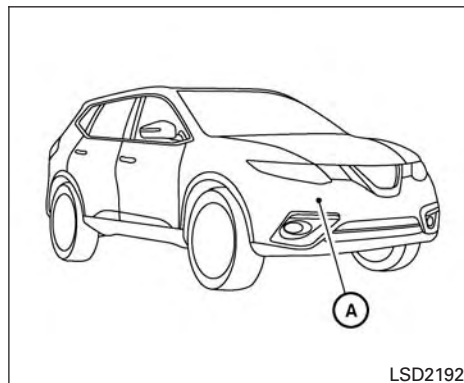

LSD2192

## SENSOR MAINTENANCE

The distance sensor for the FCW system (A) is located behind the front bumper.

To keep the FCW system operating properly, be sure to observe the following:

- Always keep the sensor area of the front bumper clean.
- Do not strike or damage the areas around the sensor.
- Do not cover or attach stickers or similar objects on the front bumper near the sensor area. This could cause failure or malfunction.

## BREAK-IN SCHEDULE

### CAUTION

**During the first 1,200 miles (2,000 km), follow these recommendations to obtain maximum engine performance and ensure the future reliability and economy of your new vehicle. Failure to follow these recommendations may result in shortened engine life and reduced engine performance.**

- Avoid driving for long periods at constant speed, either fast or slow, and do not run the engine over 4,000 RPM.
- Do not accelerate at full throttle in any gear.
- Avoid quick starts.
- Avoid hard braking as much as possible.
- Do not tow a trailer for the first 500 mi (800 km). Your engine, axle or other parts could be damaged.

## FUEL EFFICIENT DRIVING TIPS

Follow these easy-to-use Fuel Efficient Driving Tips to help you achieve the most fuel economy from your vehicle.

### 1. **Use Smooth Accelerator and Brake Pedal Application**

- Avoid rapid starts and stops
- Use smooth, gentle accelerator and brake application whenever possible
- Maintain constant speed while commuting and coast whenever possible

### 2. **Maintain Constant Speed**

- Look ahead to try and anticipate and minimize stops
- Synchronizing your speed with traffic lights allows you to reduce your number of stops
- Maintaining a steady speed can minimize red light stops and improve fuel efficiency

### 3. **Use Air Conditioning (A/C) at Higher Vehicle Speeds**

- Below 40 MPH (64 km/h), it is more efficient to open windows to cool the vehicle due to reduced engine load

- Above 40 MPH (64 km/h), it is more efficient to use A/C to cool the vehicle due to increased aerodynamic drag

- Recirculating the cool air in the cabin when the A/C is on reduces cooling load

### 4. **Drive at Economical Speeds and Distances**

- Observing the speed limit and not exceeding 60 MPH (97 km/h) (where legally allowed) can improve fuel efficiency due to reduced aerodynamic drag

- Maintaining a safe following distance behind other vehicles reduces unnecessary braking

- Safely monitoring traffic to anticipate changes in speed permits reduced braking and smooth acceleration changes

- Select a gear range suitable to road conditions

### 5. **Use Cruise Control**

- Using cruise control during highway driving helps maintain a steady speed

- Cruise control is particularly effective in providing fuel savings when driving on flat terrains

## INCREASING FUEL ECONOMY

### 6. Plan for the Shortest Route

- Utilize a map or navigation system to determine the best route to save time

### 7. Avoid Idling

- Shutting off your engine when safe for stops exceeding 30–60 seconds saves fuel and reduces emissions

### 8. Buy an Automated Pass for Toll Roads

- Automated passes permit drivers to use special lanes to maintain cruising speed through the toll and avoid stopping and starting

### 9. Winter Warm Up

- Limit idling time to minimize impact to fuel economy
- Vehicles typically need no more than 30 seconds of idling at start-up to effectively circulate the engine oil before driving
- Your vehicle will reach its ideal operating temperature more quickly while driving versus idling

### 10. Keeping your Vehicle Cool

- Park your vehicle in a covered parking area or in the shade whenever possible
- When entering a hot vehicle, opening the windows will help to reduce the inside temperature faster, resulting in reduced demand on your A/C system

- Keep your engine tuned up.
- Follow the recommended scheduled maintenance.
- Keep the tires inflated to the correct pressure. Low tire pressure increases tire wear and lowers fuel economy.
- Keep the front wheels in correct alignment. Improper alignment increases tire wear and lowers fuel economy.
- Use the recommended viscosity engine oil. See “Engine oil and oil filter recommendations” in “Technical and consumer information” later in this manual.

## PARKING/PARKING ON HILLS

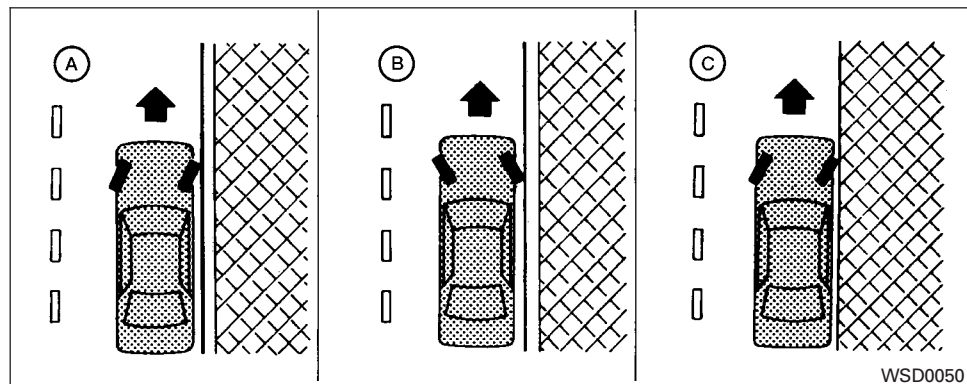

### **⚠ WARNING**

- Do not stop or park the vehicle over flammable materials such as dry grass, waste paper or rags. They may ignite and cause a fire.
- Safe parking procedures require that both the parking brake be set and the transmission placed into P (Park). Failure to do so could cause the vehicle to move unexpectedly or roll away and result in an accident. Make sure the shift lever has been pushed as far forward as it can go and cannot be moved without depressing the foot brake pedal.

- Never leave the engine running while the vehicle is unattended.
- Do not leave children unattended inside the vehicle. They could unknowingly activate switches or controls. Unattended children could become involved in serious accidents.

1. Firmly apply the parking brake.
2. Move the shift lever to the P (Park) position.
3. To help prevent the vehicle from rolling into traffic when parked on an incline, it is a good practice to turn the wheels as illustrated.

- HEADED DOWNHILL WITH CURB: **(A)**

Turn the wheels into the curb and move the vehicle forward until the curb side wheel gently touches the curb.

- HEADED UPHILL WITH CURB: **(B)**

Turn the wheels away from the curb and move the vehicle back until the curb side wheel gently touches the curb.

- HEADED UPHILL OR DOWNHILL, NO CURB: **(C)**

Turn the wheels toward the side of the road so the vehicle will move away from the center of the road if it moves.

4. Place the ignition switch in the LOCK position.

## POWER STEERING

### WARNING

- **If the engine is not running or is turned off while driving, the power assist for the steering will not work. Steering will be harder to operate.**
- **When the power steering warning light illuminates with the engine running, there will be no power assist for the steering. You will still have control of the vehicle, but the steering will be much harder to operate. Have the power steering system checked by a NISSAN dealer.**

The power steering system is designed to provide power assistance while driving to operate the steering wheel with light force.

When the steering wheel is operated repeatedly or continuously while parking or driving at a very low speed, the power assist for the steering wheel will be reduced. This is to prevent overheating of the power steering system and protect it from getting damaged. While the power assist is reduced, steering wheel operation will become heavy. If the steering wheel operation is still performed, the power steering may stop and the power steering warning light will illuminate. In a safe location, stop the engine and push the ignition switch to the OFF position. The temperature

of the power steering system will go down after a period of time and the power assist level will return to normal after starting the engine. The power steering warning light will go off. Avoid repeating such steering wheel operations that could cause the power steering system to overheat.

You may hear a noise from the front of the vehicle when the steering wheel is operated. This is a normal operational noise and is not a malfunction.

If the power steering warning light illuminates while the engine is running, it may indicate the power steering system is not functioning properly and may need servicing. Have the power steering system checked by a NISSAN dealer.

When the power steering warning light illuminates with the engine running, the power assist for the steering will cease operation but you will still have control of the vehicle. At this time, greater steering efforts are required to operate the steering wheel, especially in sharp turns and at low speeds.

## BRAKE SYSTEM

The brake system has two separate hydraulic circuits. If one circuit malfunctions, you will still have braking at 2 wheels.

### BRAKE PRECAUTIONS

#### Vacuum assisted brakes

The brake booster aids braking by using engine vacuum. If the engine stops, you can stop the vehicle by depressing the brake pedal. However, greater foot pressure on the brake pedal will be required to stop the vehicle and stopping distance will be longer.

#### Using the brakes

Avoid resting your foot on the brake pedal while driving. This will overheat the brakes, wear out the brake pads faster, and reduce gas mileage.

To help reduce brake wear and to prevent the brakes from overheating, reduce speed and downshift to a lower gear before going down a slope or long grade. Overheated brakes may reduce braking performance and could result in loss of vehicle control.

### **WARNING**

- **While driving on a slippery surface, be careful when braking, accelerating or downshifting. Abrupt braking or accelerating could cause the wheels to skid and result in an accident.**
- **If the engine is not running or is turned off while driving, the power assist for the brakes will not work. Braking will be harder.**

### Wet brakes

When the vehicle is washed or driven through water, the brakes may get wet. As a result, your braking distance will be longer and the vehicle may pull to one side during braking.

To dry the brakes, drive the vehicle at a safe speed while lightly pressing the brake pedal to heat up the brakes. Do this until the brakes return to normal. Avoid driving the vehicle at high speeds until the brakes function correctly.

### Parking brake break-in

Break-in the parking brake shoes whenever the effect of the parking brake is weakened or whenever the parking brake shoes and/or drum/rotors are replaced, in order to assure the best brake performance.

## 5-38 Starting and driving

This procedure is described in the vehicle service manual and can be performed by a NISSAN dealer.

### ANTI-LOCK BRAKING SYSTEM (ABS)

#### **WARNING**

- **The Anti-lock Braking System (ABS) is a sophisticated device, but it cannot prevent accidents resulting from careless or dangerous driving techniques. It can help maintain vehicle control during braking on slippery surfaces. Remember that stopping distances on slippery surfaces will be longer than on normal surfaces even with ABS. Stopping distances may also be longer on rough, gravel or snow covered roads, or if you are using tire chains. Always maintain a safe distance from the vehicle in front of you. Ultimately, the driver is responsible for safety.**
- **Tire type and condition may also affect braking effectiveness.**
  - **When replacing tires, install the specified size of tires on all four wheels.**

– **When installing a spare tire, make sure that it is the proper size and type as specified on the Tire and Loading Information label. See “Tire and Loading Information label” in the “Technical and consumer information” section of this manual.**

– **For detailed information, see “Wheels and tires” in the “Maintenance and do-it-yourself” section of this manual.**

The Anti-lock Braking System (ABS) controls the brakes so the wheels do not lock during hard braking or when braking on slippery surfaces. The system detects the rotation speed at each wheel and varies the brake fluid pressure to prevent each wheel from locking and sliding. By preventing each wheel from locking, the system helps the driver maintain steering control and helps to minimize swerving and spinning on slippery surfaces.

### Using the system

Depress the brake pedal and hold it down. Depress the brake pedal with firm steady pressure, but do not pump the brakes. The ABS will operate to prevent the wheels from locking up. Steer the vehicle to avoid obstacles.

 **WARNING**

**Do not pump the brake pedal. Doing so may result in increased stopping distances.**

### Self-test feature

The ABS includes electronic sensors, electric pumps, hydraulic solenoids and a computer. The computer has a built-in diagnostic feature that tests the system each time you start the engine and move the vehicle at a low speed in forward or reverse. When the self-test occurs, you may hear a "clunk" noise and/or feel a pulsation in the brake pedal. This is normal and does not indicate a malfunction. If the computer senses a malfunction, it switches the ABS off and illuminates the ABS warning light on the instrument panel. The brake system then operates normally, but without anti-lock assistance.

If the ABS warning light illuminates during the self-test or while driving, have the vehicle checked by a NISSAN dealer.

### Normal operation

The ABS operates at speeds above 3 - 6 MPH (5 - 10 km/h). The speed varies according to road conditions.

When the ABS senses that 1 or more wheels are close to locking up, the actuator rapidly applies and releases hydraulic pressure. This action is similar to pumping the brakes very quickly. You may feel a pulsation in the brake pedal and hear a noise from under the hood or feel a vibration from the actuator when it is operating. This is normal and indicates that the ABS is operating properly. However, the pulsation may indicate that road conditions are hazardous and extra care is required while driving.

### BRAKE ASSIST

When the force applied to the brake pedal exceeds a certain level, the brake assist is activated generating greater braking force than a conventional brake booster even with light pedal force.

 **WARNING**

**The brake assist is only an aid to assist braking operation and is not a collision warning or avoidance device. It is the driver's responsibility to stay alert, drive safely and be in control of the vehicle at all times.**

## VEHICLE DYNAMIC CONTROL (VDC) SYSTEM

The Vehicle Dynamic Control (VDC) system uses various sensors to monitor driver inputs and vehicle motion. Under certain driving conditions, the VDC System helps to perform the following functions:

- Controls brake pressure to reduce wheel slip on one slipping drive wheel so power is transferred to a non slipping drive wheel on the same axle.
- Controls brake pressure and engine output to reduce drive wheel slip based on vehicle speed (traction control function).
- Controls brake pressure at individual wheels and engine output to help the driver maintain control of the vehicle in the following conditions:
  - understeer (vehicle tends to not follow the steered path despite increased steering input)
  - oversteer (vehicle tends to spin due to certain road or driving conditions)



The VDC system can help the driver to maintain control of the vehicle, but it cannot prevent loss of vehicle control in all driving situations.





When the VDC system operates, the  indicator in the instrument panel flashes so note the following:

- The road may be slippery or the system may determine some action is required to help keep the vehicle on the steered path.
- You may feel a pulsation in the brake pedal and hear a noise or vibration from under the hood. This is normal and indicates that the VDC system is working properly.
- Adjust your speed and driving to the road conditions.

See "Slip indicator light" and "Vehicle Dynamic Control (VDC) OFF indicator light" in the "Instruments and controls" section.

If a malfunction occurs in the system, the  and  indicator lights come on in the instrument panel. The VDC system automatically turns off when these indicator lights are on.

The VDC OFF switch is used to turn off the VDC system. The  indicator illuminates to indicate the VDC system is off.







When the VDC switch is used to turn off the system, the VDC system still operates to prevent one drive wheel from slipping by transferring power to a non slipping drive wheel. The  indicator flashes if this occurs. All other VDC functions are off and the  indicator will not flash.

The VDC system is automatically reset to on when the ignition switch is placed in the off position then back to the on position.









The computer has a built in diagnostic feature that tests the system each time you start the engine and move the vehicle forward or in reverse at a slow speed. When the self-test occurs, you may hear a clunk noise and/or feel a pulsation in the brake pedal. This is normal and is not an indication of a malfunction.

#### WARNING

- **The VDC system is designed to help the driver maintain stability but does not prevent accidents due to abrupt steering operation at high speeds or by careless or dangerous driving techniques. Reduce vehicle speed and be especially careful when driving and cornering on slippery surfaces and always drive carefully.**

- **Do not modify the vehicle's suspension. If suspension parts such as shock absorbers, struts, springs, stabilizer bars, bushings and wheels are not NISSAN recommended for your vehicle or are extremely deteriorated, the VDC system may not operate properly. This could adversely affect vehicle handling performance, and the  indicator may flash or both the  and  indicator lights may illuminate.**
- **If brake related parts such as brake pads, rotors and calipers are not NISSAN recommended or are extremely deteriorated, the VDC system may not operate properly and both the  and the  indicator lights may illuminate.**
- **If engine control related parts are not NISSAN recommended or are extremely deteriorated, both the  and  indicator lights may illuminate.**

## CHASSIS CONTROL

- **When driving on extremely inclined surfaces such as higher banked corners, the VDC system may not operate properly and the  indicator may flash or both the  and  indicator lights may illuminate. Do not drive on these types of roads.**
- **When driving on an unstable surface such as a turntable, ferry, elevator or ramp, the  indicator may flash or both the  and  indicator lights may illuminate. This is not a malfunction. Restart the engine after driving onto a stable surface.**
- **If wheels or tires other than the NISSAN recommended ones are used, the VDC system may not operate properly and the  indicator may flash or both the  and  indicator lights may illuminate.**
- **The VDC system is not a substitute for winter tires or tire chains on a snow covered road.**

The chassis control is an electric control module that includes the following functions:

- Active Trace Control
- Active Engine Brake
- Active Ride Control

### ACTIVE TRACE CONTROL

This system senses driving based on the driver's steering and acceleration/braking patterns, and controls brake pressure at individual wheels to aid tracing at corners and help smooth vehicle response.

The Active Trace Control can be set to ON (enabled) or OFF (disabled) through the Vehicle Information Display "Settings" page. See "Vehicle Information Display" in "Instruments and Controls" for more information.

When the VDC OFF switch is used to turn off the VDC system, the Active Trace Control is also turned off.

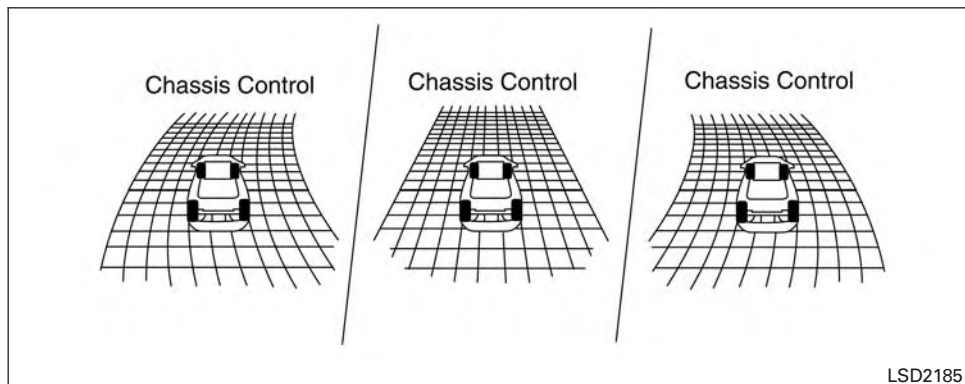

When the active trace control is operated and the “Chassis Control” mode is selected in the trip computer, the active trace control graphics are shown in the vehicle information display. See “Trip Computer” in “Instruments and Controls” for more information.

If the chassis control warning message appears in the vehicle information display, it may indicate that the active trace control is not functioning properly. Have the system checked by a NISSAN dealer as soon as possible.

#### **⚠ WARNING**

**The active trace control may not be effective depending on the driving condition. Always drive carefully and attentively.**

When the active trace control is operating, you may feel a pulsation in the brake pedal and hear a noise. This is normal and indicates that the active trace control is operating properly.

Even if the active trace control is set to OFF, some functions will remain on to assist the driver (for example: avoidance scenes).

## ACTIVE ENGINE BRAKE

The Active Engine Brake function adds subtle deceleration by controlling CVT gear ratio, depending on the cornering condition calculated from driver’s steering input and plural sensors. This benefit to easier traceability and less workload of adjusting speed with braking at corners.

The Active Engine Brake also enhances braking feel by adding subtle deceleration with CVT gear ratio control according to driver’s brake pedal operation

The Active Engine Brake can be set to ON (enabled) or OFF (disabled) through the Vehicle Information Display “Settings” page. See “Vehicle Information Display” in “Instruments and Controls” for more information.

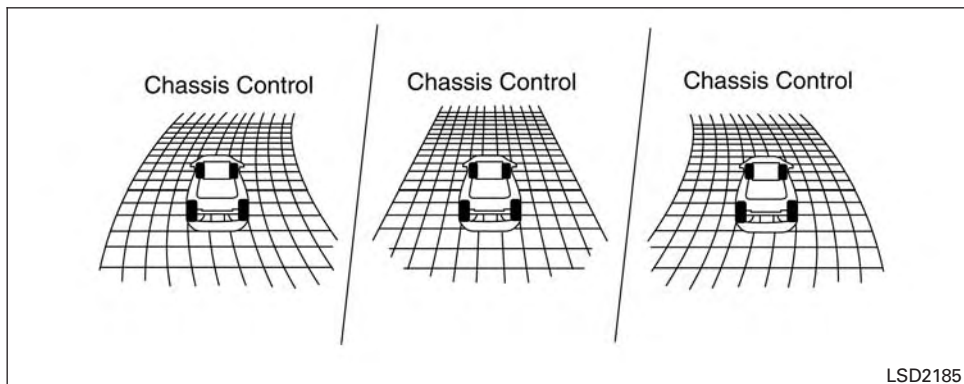

When the active engine brake is operated at corners and the “Chassis Control” mode is selected in the trip computer, the active engine brake graphics are shown in the vehicle information display. See “Trip Computer” in “Instruments and Controls” for more information.

If the chassis control warning message appears in the vehicle information display, it may indicate that the active engine brake is not functioning properly. Have the system checked by a NISSAN dealer as soon as possible.

#### **⚠ WARNING**

**The active engine brake may not be effective depending on the driving condition. Always drive carefully and attentively.**

When the active engine brake is operating, the needle of the tachometer will rise up and you may hear an engine noise. This is normal and indicates that the active engine brake is operating properly.

## ACTIVE RIDE CONTROL

This system senses upper body motion based on wheel speed information and controls engine torque and four wheel brake pressure to enhance ride comfort in effort to restrain uncomfortable upper body movement when passing over undulated road surfaces. This system come into effect above 25 mph (40 km/h).

When the VDC OFF switch is used to turn off the VDC system, the Active Ride Control is also turned off.

## HILL DESCENT CONTROL SYSTEM (if so equipped)

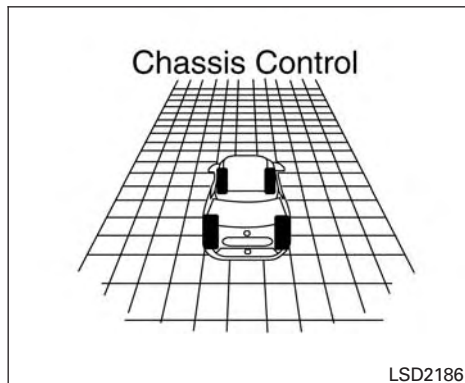

When brake control of active ride control is operated and the "Chassis Control" mode is selected in the trip computer, the active ride control graphics are shown in the vehicle information display. See "Trip Computer" in "Instruments and Controls" for more information.

If the chassis control warning message appears in the vehicle information display, it may indicate that the active ride control is not functioning properly. Have the system checked by a NISSAN dealer as soon as possible.

When the active ride control is operating, you may hear noise and sense slight deceleration. This is normal and indicates that the active ride control is operating properly.

### 5-44 Starting and driving

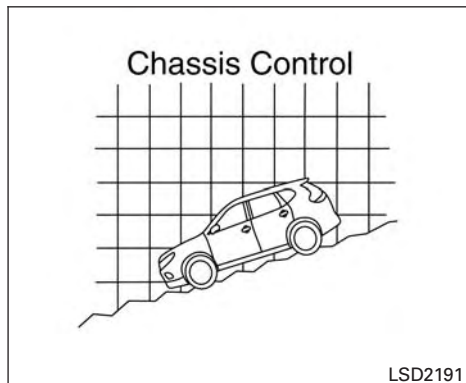

### WARNING

- **Never rely solely on the hill descent control system to control vehicle speed when driving on steep downhill grades. Always drive carefully and attentively when using the hill descent control system and decelerate the vehicle speed by depressing the brake pedal if necessary. Be especially careful when driving on frozen, muddy or extremely steep downhill roads. Failure to control vehicle speed may result in a loss of control of the vehicle and possible serious injury or death.**

- **The hill descent control may not control the vehicle speed on a hill under all load or road conditions. Always be prepared to depress the brake pedal to control vehicle speed. Failure to do so may result in a collision or serious personal injury.**

The hill descent control system helps maintain vehicle speed when driving under 15 MPH (25 km/h) on steeper downhill grades. Hill descent control is useful when engine braking alone cannot control vehicle speed. Hill descent control applies the vehicle brakes to control vehicle speed allowing the driver to concentrate on steering while reducing the burden of brake and accelerator operation.

- When additional braking is required on steep downhill roads, activate the hill descent control system by pushing the switch ON. See "Hill descent control switch" in the "Instruments and controls" section.
- Once the system is activated, the indicator light will remain on in the instrument panel. See "Hill descent control system on indicator light" in the "Instruments and controls" section.

## HILL START ASSIST SYSTEM

If the accelerator or brake pedal is depressed while the hill descent control system is on, the system will stop operating temporarily. As soon as the accelerator or brake pedal is released, the hill descent control system begins to function again if the hill descent control operating conditions are fulfilled.

For the best results, when descending steep downhill grades, the hill descent control switch should be ON and the shift lever in L (Low gear) for engine braking.

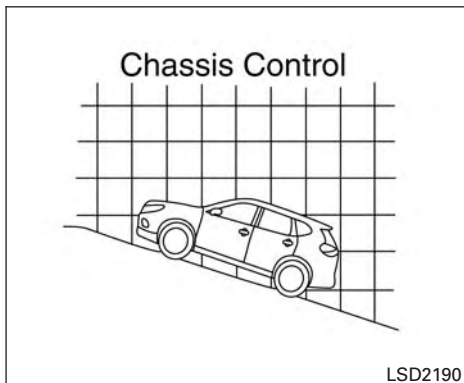

### **⚠ WARNING**

- **Never rely solely on the hill start assist system to prevent the vehicle from moving backward on a hill. Always drive carefully and attentively. Depress the brake pedal when the vehicle is stopped on a steep hill. Be especially careful when stopped on a hill on frozen or muddy roads. Failure to prevent the vehicle from rolling backwards may result in a loss of control of the vehicle and possible serious injury or death.**

- **The hill start assist system is not designed to hold the vehicle at a standstill on a hill. Depress the brake pedal when the vehicle is stopped on a steep hill. Failure to do so may cause the vehicle to roll backwards and may result in a collision or serious personal injury.**
- **The hill start assist may not prevent the vehicle from rolling backwards on a hill under all load or road conditions. Always be prepared to depress the brake pedal to prevent the vehicle from rolling backwards. Failure to do so may result in a collision or serious personal injury.**

The hill start assist system automatically keeps the brakes applied to help prevent the vehicle from rolling backward in the time it takes the driver to release the brake pedal and apply the accelerator when the vehicle is stopped on a hill.

Hill start assist will operate automatically under the following conditions:

- The shift lever is shifted to a forward or reverse gear.
- The vehicle is stopped completely on a hill by applying the brake.

## COLD WEATHER DRIVING

The maximum holding time is 2 seconds. After 2 seconds the vehicle will begin to roll back and hill start assist will stop operating completely.

Hill start assist will not operate when the shift lever is shifted into N (Neutral) or P (Park) or on a flat and level road.

### FREEING A FROZEN DOOR LOCK

To prevent a door lock from freezing, apply de-icer through the key hole. If the lock becomes frozen, heat the key before inserting it into the key hole, or use the NISSAN Intelligent Key®.

### ANTI-FREEZE

In the winter when it is anticipated that the temperature will drop below 32°F (0°C), check the anti-freeze to assure proper winter protection. For details, see “Engine cooling system” in the “Maintenance and do-it-yourself” section of this manual.

### BATTERY

If the battery is not fully charged during extremely cold weather conditions, the battery fluid may freeze and damage the battery. To maintain maximum efficiency, the battery should be checked regularly. For details, see “Battery” in the “Maintenance and do-it-yourself” section of this manual.

### DRAINING OF COOLANT WATER

If the vehicle is to be left outside without anti-freeze, drain the cooling system, including the engine block. Refill before operating the vehicle.

For details, see “Changing engine coolant” in the “Maintenance and do-it-yourself” section of this manual.

### TIRE EQUIPMENT

1. SUMMER tires have a tread designed to provide superior performance on dry pavement. However, the performance of these tires will be substantially reduced in snowy and icy conditions. If you operate your vehicle on snowy or icy roads, NISSAN recommends the use of MUD & SNOW or ALL SEASON TIRES on all four wheels. Please consult a NISSAN dealer for the tire type, size, speed rating and availability information.
2. For additional traction on icy roads, studded tires may be used. However, some U.S. states and Canadian provinces prohibit their use. Check local, state and provincial laws before installing studded tires.

**Skid and traction capabilities of studded snow tires on wet or dry surfaces may be poorer than that of non-studded snow tires.**

3. Tire chains may be used. For details see “Tire chains” in the “Maintenance and do-it-yourself” section of this manual.

## SPECIAL WINTER EQUIPMENT

It is recommended that the following items be carried in the vehicle during winter:

- A scraper and stiff-bristled brush to remove ice and snow from the windows and wiper blades.
- A sturdy, flat board to be placed under the jack to give it firm support.
- A shovel to dig the vehicle out of snowdrifts.
- Extra washer fluid to refill the windshield-washer fluid reservoir.

## DRIVING ON SNOW OR ICE

### WARNING

- **Wet ice (32°F, 0°C and freezing rain), very cold snow or ice can be slick and very hard to drive on. The vehicle will have much less traction or “grip” under these conditions. Try to avoid driving on wet ice until the road is salted or sanded.**
- **Whatever the condition, drive with caution. Accelerate and slow down with care. If accelerating or downshifting too fast, the drive wheels will lose even more traction.**

- **Allow more stopping distance under these conditions. Braking should be started sooner than on dry pavement.**
- **Allow greater following distances on slippery roads.**
- **Watch for slippery spots (glare ice). These may appear on an otherwise clear road in shaded areas. If a patch of ice is seen ahead, brake before reaching it. Try not to brake while on the ice, and avoid any sudden steering maneuvers.**
- **Do not use the cruise control on slippery roads.**
- **Snow can trap dangerous exhaust gases under your vehicle. Keep snow clear of the exhaust pipe and from around your vehicle.**

## ENGINE BLOCK HEATER (if so equipped) (Canada only)

Engine block heaters are used to assist with cold temperature starting.

The engine block heater should be used when the outside temperature is 20°F (-7°C) or lower.

### WARNING

- **Do not use your engine block heater with an ungrounded electrical system or a 2-pronged adapter. You can be seriously injured by an electrical shock if you use an ungrounded connection.**
- **Disconnect and properly store the engine block heater cord before starting the engine. Damage to the cord could result in an electrical shock and can cause serious injury.**
- **Use a heavy-duty 3-wire, 3-pronged extension cord rated for at least 10 A. Plug the extension cord into a Ground Fault Interrupt (GFI) protected, grounded 110-VAC outlet. Failure to use the proper extension cord or a grounded outlet can result in a fire or electrical shock and cause serious personal injury.**



To use the engine block heater:

1. Turn the engine off.
2. Open the hood and unwrap the engine block heater cord.
3. Plug the engine block heater cord into a grounded 3-wire, 3-pronged extension cord.
4. Plug the extension cord into a Ground Fault Interrupt (GFI) protected, grounded 110-volt AC (VAC) outlet.
5. The engine block heater must be plugged in for at least 2 - 4 hours, depending on outside temperatures, to properly warm the engine coolant. Use an appropriate timer to turn the engine block heater on.
6. Before starting the engine, unplug and properly store the cord to keep it away from moving parts.

# 6 In case of emergency

Emergency engine shut off .....	6-2	Jump starting .....	6-10
Hazard warning flasher switch .....	6-2	Push starting .....	6-12
Flat tire .....	6-3	If your vehicle overheats .....	6-12
Tire Pressure Monitoring System (TPMS).....	6-3	Towing your vehicle .....	6-13
Run-flat tires (For vehicles equipped with		Towing recommended by NISSAN .....	6-14
3rd row only) .....	6-3	Vehicle recovery (freeing a stuck vehicle).....	6-16
Changing a flat tire .....	6-4		



## EMERGENCY ENGINE SHUT OFF

To shut off the engine in an emergency situation while driving, perform the following procedure:

- Rapidly push the push-button ignition switch 3 consecutive times in less than 1.5 seconds, or
- Push and hold the push-button ignition switch for more than 2 seconds.

## HAZARD WARNING FLASHER SWITCH

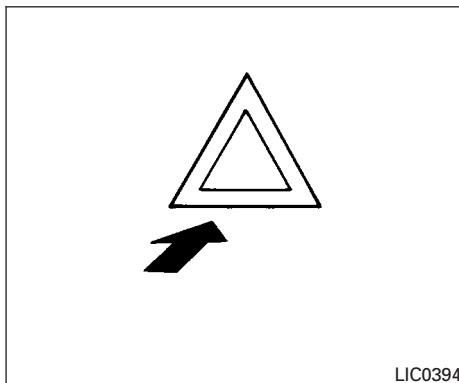

Push the switch on to warn other drivers when you must stop or park under emergency conditions. All turn signal lights flash.

The flashers will operate with the ignition switch placed in any position.

**Some state laws may prohibit the use of the hazard warning flasher switch while driving.**

### **WARNING**

- **If stopping for an emergency, be sure to move the vehicle well off the road.**
- **Do not use the hazard warning flashers while moving on the highway unless unusual circumstances force you to drive so slowly that your vehicle might become a hazard to other traffic.**
- **Turn signals do not work when the hazard warning flasher lights are on.**

## FLAT TIRE

### TIRE PRESSURE MONITORING SYSTEM (TPMS)

This vehicle is equipped with the Tire Pressure Monitoring System (TPMS). It monitors tire pressure of all tires except the spare. When the low tire pressure warning light is lit, and the Tire Pressure Low - Add Air warning appears in the vehicle information display, one or more of your tires is significantly under-inflated. If equipped, the system also displays pressure of all tires (except the spare tire) on the display screen by sending a signal from a sensor that is installed in each wheel. If the vehicle is being driven with low tire pressure, the TPMS will activate and warn you of it by the low tire pressure warning light. This system will activate only when the vehicle is driven at speeds above 16 MPH (25 km/h). For more details, refer to "Warning/indicator lights and audible reminders" in the "Instruments and controls" section and "Tire Pressure Monitoring System (TPMS)" in the "Starting and driving" section.

#### WARNING

- **Radio waves could adversely affect electric medical equipment. Those who use a pacemaker should contact the electric medical equipment manufacturer for the possible influences before use.**
- **If the low tire pressure warning light illuminates while driving, avoid sudden steering maneuvers or abrupt braking, reduce vehicle speed, pull off the road to a safe location and stop the vehicle as soon as possible. Driving with under-inflated tires may permanently damage the tires and increase the likelihood of tire failure. Serious vehicle damage could occur and may lead to an accident and could result in serious personal injury. Check the tire pressure for all four tires. Adjust the tire pressure to the recommended COLD tire pressure shown on the Tire and Loading Information label to turn the low tire pressure warning light OFF. If you have a flat tire, replace it with a spare tire as soon as possible.**

- **When a spare tire is mounted or a wheel is replaced, tire pressure will not be indicated, the TPMS will not function and the low tire pressure warning light will flash for approximately 1 minute. The light will remain on after 1 minute. Contact your NISSAN dealer as soon as possible for tire replacement and/or system resetting.**
- **Replacing tires with those not originally specified by NISSAN could affect the proper operation of the TPMS.**
- **Do not inject any tire liquid or aerosol tire sealant into the tires, as this may cause a malfunction of the tire pressure sensors.**

### RUN-FLAT TIRES (For vehicles equipped with 3rd row only)

Run-flat tires are those tires that can be used temporarily if they are punctured. See "Run-flat tires" in "Maintenance and do-it-yourself."

Also, see the tire safety information in the Warranty Information Booklet.

### WARNING

- Although you can continue driving with a punctured run-flat tire, remember that vehicle handling stability is reduced, which could lead to an accident and personal injury. Also, driving a long distance at high speeds may damage the tires.
- Do not drive at speeds above 50 MPH (80 km/h) and do not drive more than approximately 93 miles (150 km) with a punctured run-flat tire. The actual distance the vehicle can be driven on a flat tire depends on outside temperature, vehicle load, road conditions and other factors.
- Drive safely at reduced speeds. Avoid hard cornering or braking, which may cause you to lose control of the vehicle.
- If you detect any unusual sounds or vibrations while driving with a punctured run-flat tire, pull off the road to a safe location and stop the vehicle as soon as possible. The tire may be seriously damaged and need to be replaced.

### CAUTION

- Never install tire chains on a punctured run-flat tire, as this could damage your vehicle.
- Avoid diving over any projection or pothole, as the clearance between the vehicle and the ground is smaller than normal.
- Do not enter an automated car wash with a punctured run-flat tire.
- Have the punctured tire inspected by a NISSAN dealer or other authorized repair shop. Replace the tire as soon as possible if the tire is seriously damaged.

## CHANGING A FLAT TIRE

If you have a flat tire, follow the instructions below:

### Stopping the vehicle

1. Safely move the vehicle off the road and away from traffic.
2. Turn on the hazard warning flashers.
3. Park on a level surface and apply the parking brake. Move the shift lever to P (Park).

4. Turn off the engine.

5. Raise the hood to warn other traffic and to signal professional road assistance personnel that you need assistance.
6. Have all passengers get out of the vehicle and stand in a safe place, away from traffic and clear of the vehicle.

### WARNING

- Make sure the parking brake is securely applied and the shift lever is shifted into P (Park).
- Never change tires when the vehicle is on a slope, ice or slippery areas. This is hazardous.
- Never change tires if oncoming traffic is close to your vehicle. Wait for professional road assistance.

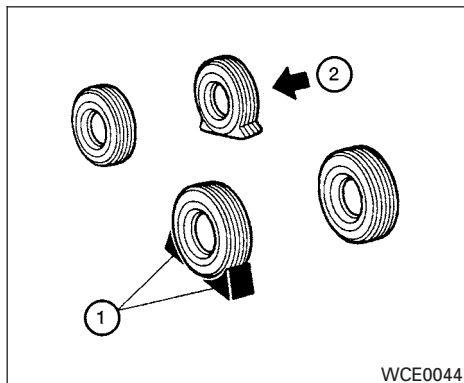

WCE0044

## Blocking wheels

Place suitable blocks ① at both the front and back of the wheel diagonally opposite the flat tire ② to prevent the vehicle from moving when it is jacked up.

### **WARNING**

**Be sure to block the wheel as the vehicle may move and result in personal injury.**

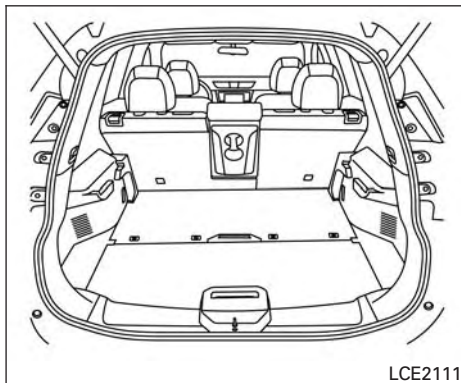

LCE2111

## Getting the spare tire and tools (If so equipped)

Open the rear hatch. Remove the Divide-n-Hide floor. Refer to "Divide-n-Hide adjustable floor" in the "Instruments and Controls" section of this manual.

Lift the floorboard.

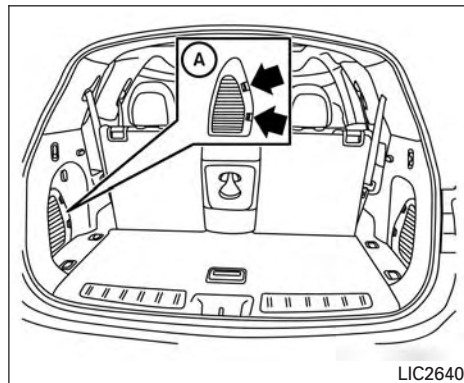

LIC2640

1. The jack and tool kit are located in the storage compartment to the left.
2. Remove the storage door by pressing the two release tabs **A** simultaneously.

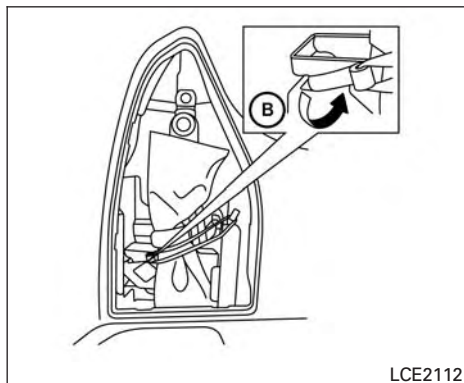

3. Unhook the clip **B** restraining the jack and tool kit.
4. Remove the tool kit.
5. Remove the jack.

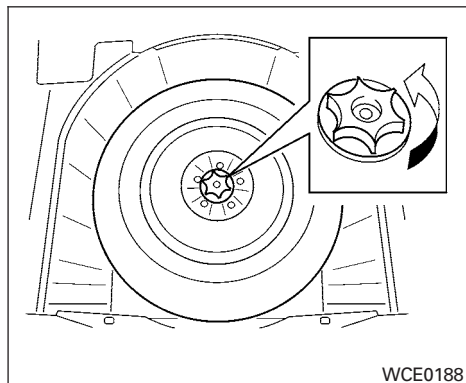

6. To loosen the bolt, turn counterclockwise.
7. Once loosened, remove the bolt.
8. Remove the spare tire.
9. Once the flat tire is exchanged with the spare tire, store the flat tire where the spare tire was located.
10. Turn the bolt clockwise to tighten.

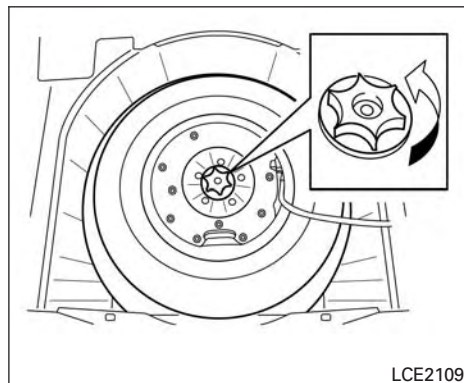

### Changing the spare tire with BOSE® sub-woofer (If so equipped)

1. To loosen the bolt, turn counterclockwise.
2. Once loosened, remove the bolt.

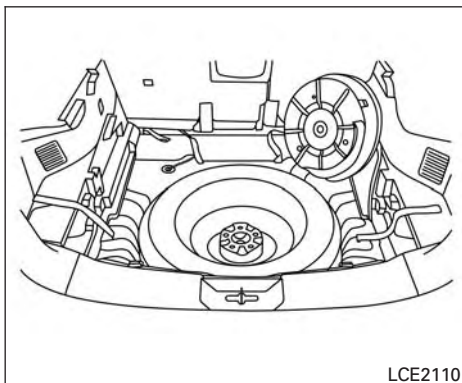

3. Place the sub-woofer in the upper right corner of the trunk, leaning against the 2nd row passenger side seat.
4. Remove the spare tire.
5. Once the flat tire is exchanged with the spare tire, store the flat tire where the spare was located.
6. Place the sub-woofer inside the flat tire.
7. Turn the bolt clockwise to tighten.

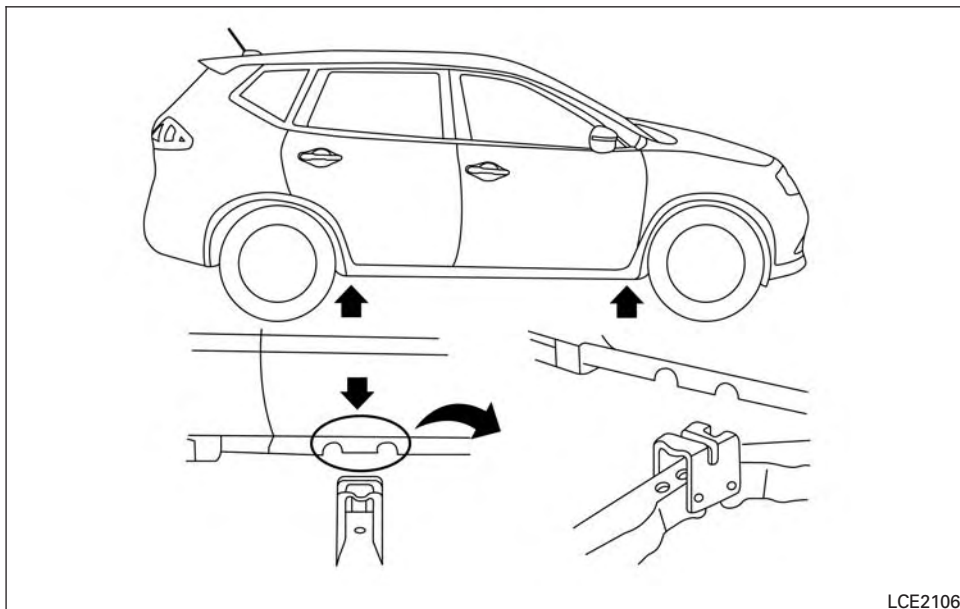



Jacking up vehicle and removing the damaged tire

**⚠ WARNING**

- **Never get under the vehicle while it is supported only by the jack. If it is necessary to work under the vehicle, support it with safety stands.**
- **Use only the jack provided with your vehicle to lift the vehicle. Do not use the jack provided with your vehicle on other vehicles. The jack is designed for lifting only your vehicle during a tire change.**
- **Use the correct jack-up points. Never use any other part of the vehicle for jack support.**
- **Never jack up the vehicle more than necessary.**
- **Never use blocks on or under the jack.**
- **Do not start or run the engine while vehicle is on the jack. It may cause the vehicle to move. This is especially true for vehicles with limited slip differentials.**
- **Do not allow passengers to stay in the vehicle while it is on the jack.**

- **Never run the engine with a wheel(s) off the ground. It may cause the vehicle to move.**

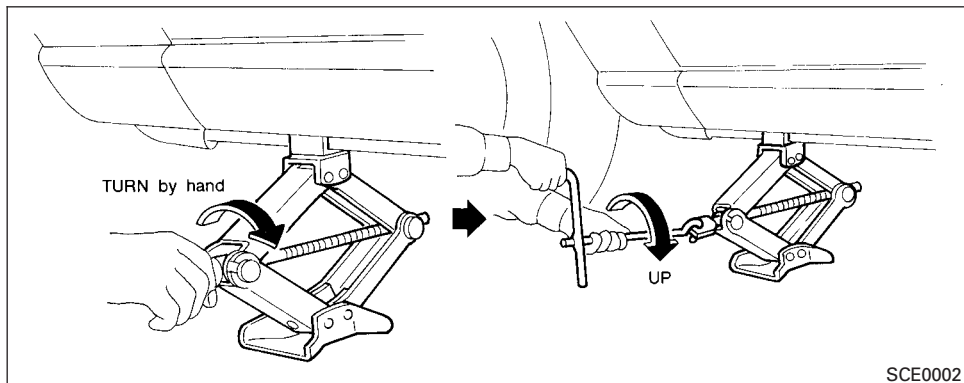

Always refer to the proper illustrations for the correct placement and jack-up points for your specific vehicle model and jack type.

**Carefully read the caution label attached to the jack body and the following instructions.**

1. Loosen each wheel nut one or two turns by turning counterclockwise with the wheel nut wrench. **Do not remove the wheel nuts until the tire is off the ground.**

2. Place the jack directly under the jack-up point as illustrated so the top of the jack contacts the vehicle at the jack-up point. Align the jack head between the two notches in the front or the rear as shown. Also fit the groove of the jack head between the notches as shown.

**The jack should be used on firm and level ground.**

3. To lift the vehicle, securely hold the jack lever and rod with both hands. Carefully raise the vehicle until the tire clears the ground. Remove the wheel nuts, and then remove the tire.

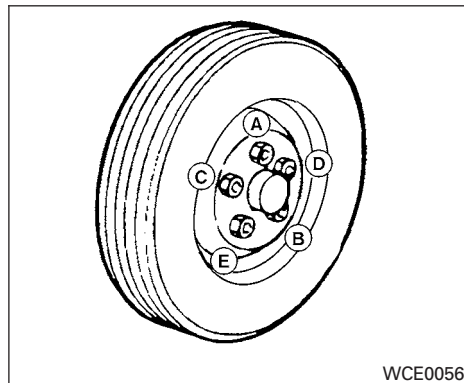

Installing the spare tire (If so equipped)

**The spare tire is designed for emergency use. See specific instructions under the heading “Wheels and tires” in the “Maintenance and do-it-yourself” section of this manual.**

1. Clean any mud or dirt from the surface between the wheel and hub.
2. Carefully put the spare tire on and tighten the wheel nuts finger tight.

3. With the wheel nut wrench, tighten wheel nuts alternately and evenly as illustrated until they are tight.
4. Lower the vehicle slowly until the tire touches the ground. Then, with the wheel nut wrench, tighten the wheel nuts securely in the sequence illustrated (A), (B), (C), (D), (E). Lower the vehicle completely.

#### **WARNING**

- **Incorrect wheel nuts or improperly tightened wheel nuts can cause the wheel to become loose or come off. This could cause an accident.**
- **Do not use oil or grease on the wheel studs or nuts. This could cause the nuts to become loose.**
- **Retighten the wheel nuts when the vehicle has been driven for 600 miles (1,000 km) (also in cases of a flat tire, etc.).**

**As soon as possible, tighten the wheel nuts to the specified torque with a torque wrench.**

#### **Wheel nut tightening torque:**

**83 ft-lb (113 N-m)**

**The wheel nuts must be kept tightened to specification at all times. It is recommended that wheel nuts be tightened to specifications at each lubrication interval.**

**Adjust tire pressure to the COLD pressure.**

**COLD pressure:** After vehicle has been parked for three hours or more or driven less than 1 mile (1.6 km).

**COLD** tire pressures are shown on the tire and loading information label affixed to the driver side center pillar.

## **JUMP STARTING**

To start your engine with a booster battery, the instructions and precautions below must be followed.

#### **WARNING**

- **If done incorrectly, jump starting can lead to a battery explosion, resulting in severe injury or death. It could also damage your vehicle.**
- **Explosive hydrogen gas is always present in the vicinity of the battery. Keep all sparks and flames away from the battery.**
- **Do not allow battery fluid to come into contact with eyes, skin, clothing or painted surfaces. Battery fluid is a corrosive sulfuric acid solution which can cause severe burns. If the fluid should come into contact with anything, immediately flush the contacted area with water.**
- **Keep battery out of the reach of children.**
- **The booster battery must be rated at 12 volts. Use of an improperly rated battery can damage your vehicle.**

- Whenever working on or near a battery, always wear suitable eye protectors (for example, goggles or industrial safety spectacles) and remove rings, metal bands, or any other jewelry. Do not lean over the battery when jump starting.
- Do not attempt to jump start a frozen battery. It could explode and cause serious injury.
- Your vehicle has an automatic engine cooling fan. It could come on at any time. Keep hands and other objects away from it.

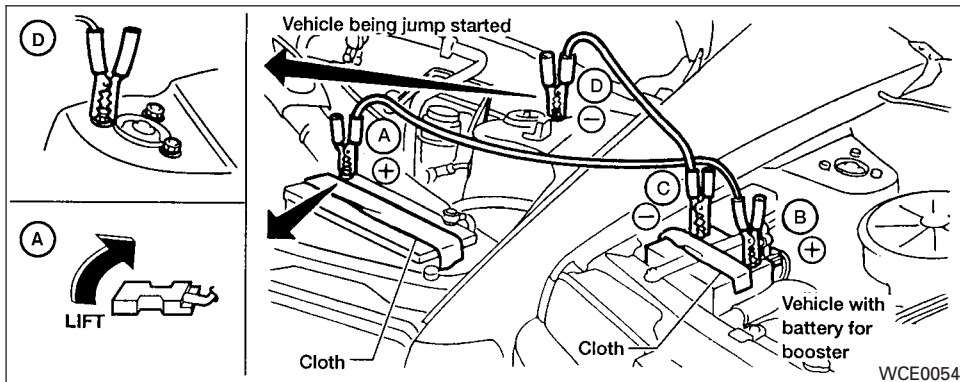

### **⚠ WARNING**

**Always follow the instructions below. Failure to do so could result in damage to the charging system and cause personal injury.**

1. If the booster battery is in another vehicle, position the two vehicles to bring their batteries near each other.

**Do not allow the two vehicles to touch.**

2. Apply the parking brake. Move the shift lever to P (Park). Switch off all unnecessary electrical systems (lights, heater, air conditioner, etc.).

3. Remove the vent caps on the battery (if so equipped). Cover the battery with an old cloth to reduce explosion hazard.
4. Connect the jumper cables in the sequence illustrated (A, B, C, D).

## PUSH STARTING

### CAUTION

- Always connect positive (+) to positive (+) and negative (-) to body ground (for example, strut mounting bolt, engine lift bracket, etc.) — not to the battery.
- Make sure the jumper cables do not touch moving parts in the engine compartment and that the cable clamps do not contact any other metal.

5. Start the engine of the booster vehicle and let it run for a few minutes.
6. Keep the engine speed of the booster vehicle at about 2,000 rpm and start the engine of the vehicle being jump started.

### CAUTION

**Do not keep the starter motor engaged for more than 10 seconds. If the engine does not start right away, place the ignition switch in the OFF position and wait 3 to 4 seconds before trying again.**

7. After starting the engine, carefully disconnect the negative cable and then the positive cable.
8. Replace the vent caps (if so equipped). Be sure to dispose of the cloth used to cover the vent holes as it may be contaminated with corrosive acid.

## 6-12 In case of emergency

### CAUTION

- CVT models cannot be push-started or tow-started. Attempting to do so may cause transmission damage.
- Do not push start this vehicle. The three-way catalyst may be damaged.

## IF YOUR VEHICLE OVERHEATS

### WARNING

- Do not continue to drive if your vehicle overheats. Doing so could cause engine damage or a vehicle fire.
- To avoid the danger of being scalded, never remove the radiator or coolant reservoir cap while the engine is still hot. When the radiator or coolant reservoir cap is removed, pressurized hot water will spurt out, possibly causing serious injury.
- Do not open the hood if steam is coming out.

If your vehicle is overheating (indicated by an extremely high temperature gauge reading and the illumination of the engine oil pressure/engine coolant temperature high indicator light), or if you feel a lack of engine power, detect abnormal noise, etc. take the following steps.

1. Move the vehicle safely off the road, apply the parking brake and move the shift lever to P (Park).

### **Do not stop the engine.**

2. Turn off the air conditioner. Open all the windows, move the heater or air conditioner temperature control to maximum hot and fan control to high speed.

3. Get out of the vehicle. Look and listen for steam or coolant escaping from the radiator before opening the hood. (If steam or coolant is escaping, turn off the engine.) Do not open the hood further until no steam or coolant can be seen.
4. Open the engine hood.

**⚠ WARNING**

**If steam or water is coming from the engine, stand clear to prevent getting burned.**

5. Visually check drive belts for damage or looseness. Also check if the cooling fan is running. The radiator hoses and radiator should not leak water. If coolant is leaking, the water pump belt is missing or loose, or the cooling fan does not run, stop the engine.

**⚠ WARNING**

**Be careful not to allow your hands, hair, jewelry or clothing to come into contact with, or get caught in, engine belts or the engine cooling fan. The engine cooling fan can start at any time.**

6. After the engine cools down, check the coolant level in the engine coolant reservoir tank with the engine running. Add coolant to the engine coolant reservoir tank if necessary. Have your vehicle repaired at a NISSAN dealer.

## TOWING YOUR VEHICLE

When towing your vehicle, all State (Provincial in Canada) and local regulations for towing must be followed. Incorrect towing equipment could damage your vehicle. Towing instructions are available from a NISSAN dealer. Local service operators are generally familiar with the applicable laws and procedures for towing. To assure proper towing and to prevent accidental damage to your vehicle, NISSAN recommends having a service operator tow your vehicle. It is advisable to have the service operator carefully read the following precautions:

**⚠ WARNING**

- **Never ride in a vehicle that is being towed.**
- **Never get under your vehicle after it has been lifted by a tow truck.**

**⚠ CAUTION**

- **When towing, make sure that the transmission, axles, steering system and powertrain are in working condition. If any of these conditions apply, dollies or a flatbed tow truck must be used.**
- **Always attach safety chains before towing.**

For information about towing your vehicle behind a recreational vehicle (RV), refer to “Flat towing” in the “Technical and consumer information” section of this manual.

## TOWING RECOMMENDED BY NISSAN

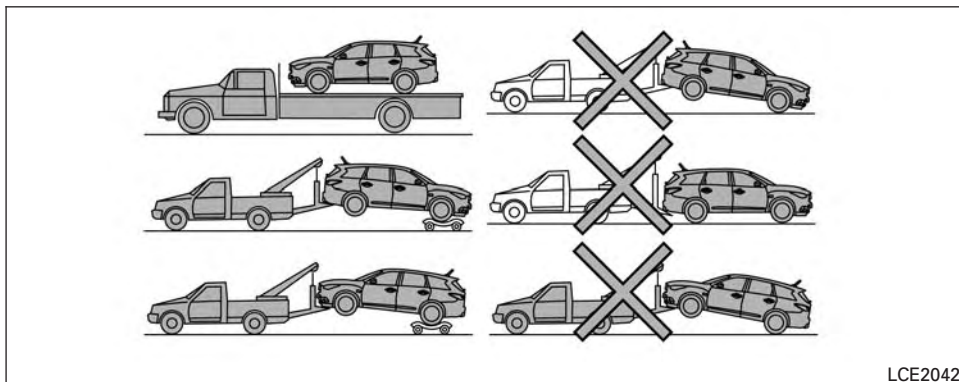

LCE2042

### All-Wheel Drive (AWD) models

NISSAN recommends that towing dollies be used when towing your vehicle or the vehicle be placed on a flatbed truck as illustrated.

#### CAUTION

**Never tow AWD models with any of the wheels on the ground as this may cause serious and expensive damage to the powertrain.**

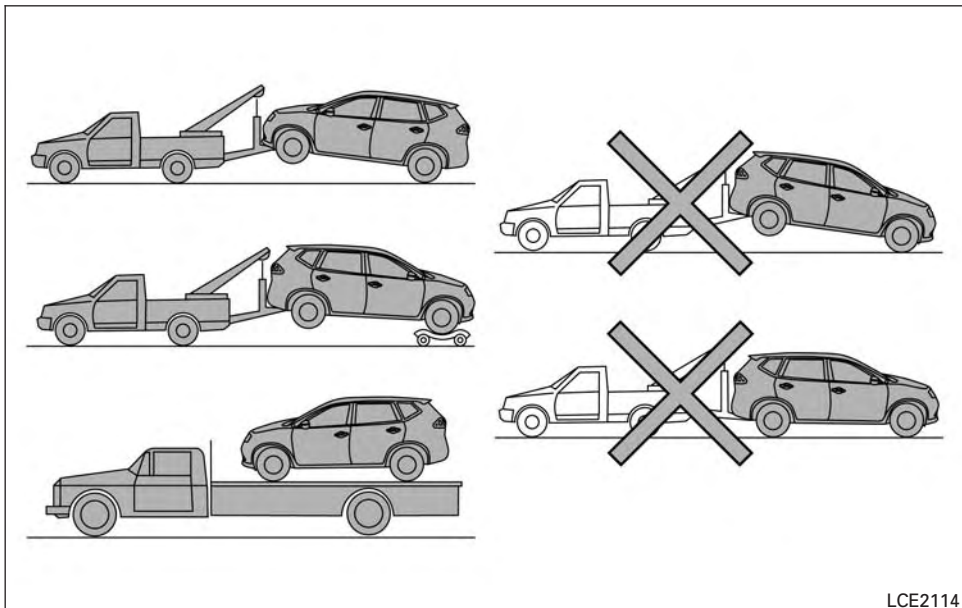

### Front-Wheel Drive models

NISSAN recommends that your vehicle be towed with the driving wheels (front) off the ground or place the vehicle on a flatbed truck as illustrated.

### WARNING

- Never tow your vehicle with the front wheels on the ground or four wheels on the ground (forward or backward), as this may cause serious and expensive damage to the transmission. If it is necessary to tow the vehicle with the rear wheels raised always use towing dollies under the front wheels.
- When towing with the rear wheels on the ground or on towing dollies, place the ignition switch in the ON position, and secure the steering wheel in the straight-ahead position with a rope or similar device.



## VEHICLE RECOVERY (freeing a stuck vehicle)

### Pulling a stuck vehicle

#### **WARNING**

**To avoid vehicle damage, serious personal injury or death when recovering a stuck vehicle:**

- **Contact a professional towing service to recover the vehicle if you have any questions regarding the recovery procedure.**
- **Attach recovery devices only to main structural members of the vehicle or the recovery hooks.**
- **Do not use the vehicle tie-downs to tow or free a stuck vehicle.**
- **Only use devices specifically designed for vehicle recovery and follow the manufacturer's instructions.**
- **Always pull the recovery device straight out from the front of the vehicle. Never pull at an angle.**
- **Route recovery devices so they do not touch any part of the vehicle except the attachment point.**

If your vehicle is stuck in sand, snow, mud, etc., use a tow strap or other device designed specifically for vehicle recovery. Always follow the manufacturer's instructions for the recovery device.

Do not use the tie-down hooks for towing or vehicle recovery.

### Rocking a stuck vehicle

#### **WARNING**

- **Stand clear of a stuck vehicle.**
- **Do not spin your tires at high speed. This could cause them to explode and result in serious injury. Parts of your vehicle could also overheat and be damaged.**

If your vehicle is stuck in sand, snow, mud, etc., use the following procedure:

1. Turn off the Vehicle Dynamic Control System (VDC).
2. Make sure the area in front and behind the vehicle is clear of obstructions.
3. Turn the steering wheel right and left to clear an area around the front tires.
4. Slowly rock the vehicle forward and backward.

- Shift back and forth between R (Reverse) and D (Drive).
  - Apply the accelerator as little as possible to maintain the rocking motion.
  - Release the accelerator pedal before shifting between R and D.
  - Do not spin the tires above 35 MPH (55 km/h).
5. If the vehicle cannot be freed after a few tries, contact a professional towing service to remove the vehicle.

# 7 Appearance and care

Cleaning exterior .....	7-2	Air fresheners .....	7-4
Washing .....	7-2	Floor mats .....	7-4
Waxing .....	7-2	Seat belts .....	7-5
Removing spots .....	7-3	Cleaning the seat tracks .....	7-5
Underbody .....	7-3	Corrosion protection .....	7-5
Glass .....	7-3	Most common factors contributing to vehicle	
Aluminum alloy wheels (if so equipped) .....	7-3	corrosion .....	7-5
Chrome parts .....	7-3	Environmental factors influence the rate of	
Tire dressings .....	7-3	corrosion .....	7-5
Cleaning interior .....	7-4	To protect your vehicle from corrosion .....	7-6



## CLEANING EXTERIOR

In order to maintain the appearance of your vehicle, it is important to take proper care of it.

To protect the paint surfaces, please wash your vehicle as soon as you can:

- after a rainfall to prevent possible damage from acid rain.
- after driving on coastal roads.
- when contaminants such as soot, bird droppings, tree sap, metal particles or bugs get on the paint surface.
- when dust or mud builds up on the surface.

Whenever possible, store or park your vehicle inside a garage or in a covered area.

When it is necessary to park outside, park in a shady area or protect the vehicle with a body cover.

**Be careful not to scratch the paint surface when putting on or removing the body cover.**

### WASHING

Wash dirt off with a wet sponge and plenty of water. Clean the vehicle thoroughly using a mild soap, a special vehicle soap or general purpose dishwashing liquid mixed with clean, lukewarm (never hot) water.

#### 7-2 Appearance and care

### CAUTION

- **Do not use car washes that use acid in the detergent. Some car washes, especially brushless ones, use some acid for cleaning. The acid may react with some plastic vehicle components, causing them to crack. This could affect their appearance, and also could cause them not to function properly. Always check with your car wash to confirm that acid is not used.**
- **Do not wash the vehicle with strong household soap, strong chemical detergents, gasoline or solvents.**
- **Do not wash the vehicle in direct sunlight or while the vehicle body is hot, as the surface may become water-spotted.**
- **Avoid using tight-napped or rough cloths, such as washing mitts. Care must be taken when removing caked-on dirt or other foreign substances so the paint surface is not scratched or damaged.**

Rinse the vehicle thoroughly with plenty of clean water.

Inside flanges, seams and folds on the doors, hatches and hood are particularly vulnerable to the effects of road salt. Therefore, these areas must be cleaned regularly. Take care that the drain holes in the lower edge of the door are open. Spray water under the body and in the wheel wells to loosen the dirt and wash away road salt.

A damp chamois can be used to dry the vehicle to avoid water spots.

### WAXING

Regular waxing protects the paint surface and helps retain new vehicle appearance. Polishing is recommended to remove built-up wax residue and to avoid a weathered appearance before re-applying wax.

A NISSAN dealer can assist you in choosing the proper product.

- Wax your vehicle only after a thorough washing. Follow the instructions supplied with the wax.
- Do not use a wax containing any abrasives, cutting compounds or cleaners that may damage the vehicle finish.

Machine compounding or aggressive polishing on a base coat/clear coat paint finish may dull the finish or leave swirl marks.

## REMOVING SPOTS

Remove tar and oil spots, industrial dust, insects, and tree sap as quickly as possible from the surface of the paint to avoid lasting damage or staining. Special cleaning products are available at a NISSAN dealer or any automotive accessory store.

## UNDERBODY

In areas where road salt is used in winter, it is necessary to clean the underbody regularly in order to prevent dirt and salt from building up and causing the acceleration of corrosion on the underbody and suspension. Before the winter period and again in the spring, the underseal must be checked and, if necessary, retreated.

## GLASS

Use glass cleaner to remove smoke and dust film from the glass surfaces. It is normal for glass to become coated with a film after the vehicle is parked in the hot sun. Glass cleaner and a soft cloth will easily remove this film.

### CAUTION

**When cleaning the inside of the windows, do not use sharp-edged tools, abrasive cleaners or chlorine-based disinfectant cleaners. They could damage the electrical conductors, radio antenna elements or rear window defroster elements.**

## ALUMINUM ALLOY WHEELS (if so equipped)

Wash the wheels regularly with a sponge dampened in a mild soap solution, especially during winter months in areas where road salt is used. If not removed, road salt can discolor the wheels.

### CAUTION

**Follow the directions below to avoid staining or discoloring the wheels:**

- **Do not use a cleaner that uses strong acid or alkali contents to clean the wheels.**
- **Do not apply wheel cleaners to the wheels when they are hot. The wheel temperature should be the same as ambient temperature.**
- **Rinse the wheel to completely remove the cleaner within 15 minutes after the cleaner is applied.**

## CHROME PARTS

Clean all chrome parts regularly with a non-abrasive chrome polish to maintain the finish.

## TIRE DRESSINGS

NISSAN does not recommend the use of tire dressings. Tire manufacturers apply a coating to the tires to help reduce discoloration of the rubber. If a tire dressing is applied to the tires, it may react with the coating and form a compound. This compound may come off the tire while driving and stain the vehicle paint.

If you choose to use a tire dressing, take the following precautions:

- Use a water-based tire dressing. The coating on the tire dissolves more easily than with an oil-based tire dressing.
- Apply a light coat of tire dressing to help prevent it from entering the tire tread/grooves (where it would be difficult to remove).
- Wipe off excess tire dressing using a dry towel. Make sure the tire dressing is completely removed from the tire tread/grooves.
- Allow the tire dressing to dry as recommended by the tire dressing manufacturer.

## CLEANING INTERIOR

Occasionally remove loose dust from the interior trim, plastic parts and seats using a vacuum cleaner or soft bristled brush. Wipe the vinyl and leather surfaces with a clean, soft cloth dampened in mild soap solution, then wipe clean with a dry, soft cloth.

Regular care and cleaning is required in order to maintain the appearance of the leather.

Before using any fabric protector, read the manufacturer's recommendations. Some fabric protectors contain chemicals that may stain or bleach the seat material.

Use a cloth dampened only with water to clean the meter and gauge lens.

### WARNING

**Do not use water or acidic cleaners (hot steam cleaners) on the seat. This can damage the seat or occupant classification sensor. This can also affect the operation of the air bag system and result in serious personal injury.**

## 7-4 Appearance and care

### CAUTION

- **Never use benzine, thinner or any similar material.**
- **Small dirt particles can be abrasive and damaging to leather surfaces and should be removed promptly. Do not use saddle soap, car waxes, polishes, oils, cleaning fluids, solvents, detergents or ammonia-based cleaners as they may damage the leather's natural finish.**
- **Never use fabric protectors unless recommended by the manufacturer.**
- **Do not use glass or plastic cleaner on meter or gauge lens covers. It may damage the lens cover.**

## AIR FRESHENERS

Most air fresheners use a solvent that could affect the vehicle interior. If you use an air freshener, take the following precautions:

- Hanging-type air fresheners can cause permanent discoloration when they contact vehicle interior surfaces. Place the air freshener in a location that allows it to hang free and not contact an interior surface.

- Liquid-type air fresheners typically clip on the vents. These products can cause immediate damage and discoloration when spilled on interior surfaces.

Carefully read and follow the manufacturer's instructions before using the air fresheners.

## FLOOR MATS

### WARNING

**To avoid potential pedal interference that may result in a collision or injury:**

- **NEVER place a floor mat on top of another floor mat in the driver front position.**
- **Use only genuine NISSAN floor mats specifically designed for use in your vehicle model. See your NISSAN dealer for more information.**
- **Properly position the mats in the floorwell using the floor mat positioning aid. See "Floor mat positioning aid" in this section.**

The use of genuine NISSAN floor mats can extend the life of your vehicle carpet and make it easier to clean the interior. Mats should be maintained with regular cleaning and replaced if they become excessively worn.



### Floor mat positioning aid

This vehicle includes two driver's side front floor mat brackets and two passenger's side front floor mat brackets to help keep your floor mats in place. Genuine NISSAN floor mats have been specially designed for your vehicle model. The driver's and passenger's side floor mats have two grommet holes incorporated in them. Position each mat by placing the floor mat bracket hook through the floor mat grommet holes while centering the mat in the floorwell.

Periodically check to make certain the mats are properly positioned.

### SEAT BELTS

The seat belts can be cleaned by wiping them with a sponge dampened in a mild soap solution. Allow the belts to dry completely in the shade before using them. See "Seat belt maintenance" in the "Safety – Seats, seat belts and supplemental restraint system" section of this manual.

#### **⚠ WARNING**

**Do not allow wet seat belts to roll up in the retractor. NEVER use bleach, dye or chemical solvents to clean the seat belts, since these materials may severely weaken the seat belt webbing.**

### CLEANING THE SEAT TRACKS

#### **⚠ CAUTION**

**Periodically clean the seat tracks to prevent reduction of ability to move the seats.**

Clean periodically with a high-powered vacuum cleaner. Dirt and debris may reduce the ability to adjust the seat. A wet cleansing agent may be used if necessary.

## CORROSION PROTECTION

### MOST COMMON FACTORS CONTRIBUTING TO VEHICLE CORROSION

- The accumulation of moisture-retaining dirt and debris in body panel sections, cavities, and other areas.
- Damage to paint and other protective coatings caused by gravel and stone chips or minor traffic accidents.

### ENVIRONMENTAL FACTORS INFLUENCE THE RATE OF CORROSION

#### Moisture

Accumulation of sand, dirt and water on the vehicle body underside can accelerate corrosion. Wet floor coverings will not dry completely inside the vehicle and should be removed for drying to avoid floor panel corrosion.

#### Relative humidity

Corrosion will be accelerated in areas of high relative humidity, especially those areas where the temperatures stay above freezing and where atmospheric pollution exists and road salt is used.

## Temperature

High temperatures accelerate the rate of corrosion to those parts which are not well ventilated.

## Air pollution

Industrial pollution, the presence of salt in the air in coastal areas, or heavy road salt use accelerates the corrosion process. Road salt also accelerates the disintegration of paint surfaces.

## TO PROTECT YOUR VEHICLE FROM CORROSION

- Wash and wax your vehicle often to keep the vehicle clean.
- Always check for minor damage to the paint and repair it as soon as possible.
- Keep drain holes at the bottom of the doors open to avoid water accumulation.
- Check the underbody for accumulation of sand, dirt or salt. If present, wash with water as soon as possible.

### CAUTION

- **NEVER** remove dirt, sand or other debris from the passenger compartment by washing it out with a hose. Remove dirt with a vacuum cleaner or broom.
- **Never allow water or other liquids to come in contact with electronic components inside the vehicle as this may damage them.**

Chemicals used for road surface de-icing are extremely corrosive. They accelerate corrosion and deterioration of underbody components such as the exhaust system, fuel and brake lines, brake cables, floor pan and fenders.

### **In winter, the underbody must be cleaned periodically.**

For additional protection against rust and corrosion, which may be required in some areas, consult a NISSAN dealer.

# 8 Maintenance and do-it-yourself

Maintenance requirements . . . . .	8-2	Air cleaner . . . . .	8-17
General maintenance . . . . .	8-2	In-cabin microfilter . . . . .	8-18
Explanation of general maintenance items . . . . .	8-2	Windshield wiper blades . . . . .	8-18
Maintenance precautions . . . . .	8-5	Cleaning . . . . .	8-18
Engine compartment check locations . . . . .	8-6	Replacing . . . . .	8-18
Engine cooling system . . . . .	8-7	Brakes . . . . .	8-20
Checking engine coolant level . . . . .	8-8	Fuses . . . . .	8-21
Changing engine coolant . . . . .	8-8	Engine compartment . . . . .	8-22
Engine oil . . . . .	8-9	Passenger compartment . . . . .	8-23
Checking engine oil level . . . . .	8-9	Battery replacement . . . . .	8-25
Changing engine oil . . . . .	8-10	NISSAN JACKKNIFE KEY (if so equipped) . . . . .	8-25
Changing engine oil filter . . . . .	8-11	NISSAN Intelligent Key® (if so equipped) . . . . .	8-26
Continuously Variable Transmission (CVT) fluid . . . . .	8-12	Lights . . . . .	8-27
Brake fluid . . . . .	8-12	Headlights . . . . .	8-27
Windshield-washer fluid . . . . .	8-12	Fog lights (if so equipped) . . . . .	8-28
Windshield-washer fluid reservoir . . . . .	8-12	Exterior and interior lights . . . . .	8-29
Battery . . . . .	8-13	Wheels and tires . . . . .	8-32
Jump starting . . . . .	8-15	Tire pressure . . . . .	8-32
Variable voltage control system . . . . .	8-15	Tire labeling . . . . .	8-36
Drive belt . . . . .	8-16	Types of tires . . . . .	8-38
Spark plugs . . . . .	8-16	Tire chains . . . . .	8-40
Replacing spark plugs . . . . .	8-16	Changing wheels and tires . . . . .	8-41



## MAINTENANCE REQUIREMENTS

Your NISSAN has been designed to have minimum maintenance requirements with long service intervals to save you both time and money. However, some day-to-day and regular maintenance is essential to maintain your NISSAN's good mechanical condition, as well as its emissions and engine performance.

It is the owner's responsibility to make sure that the scheduled maintenance, as well as general maintenance, is performed.

As the vehicle owner, you are the only one who can ensure that your vehicle receives proper maintenance. You are a vital link in the maintenance chain.

### Scheduled maintenance

For your convenience, both required and optional scheduled maintenance items are described and listed in your "NISSAN Service and Maintenance Guide". You must refer to that guide to ensure that necessary maintenance is performed on your NISSAN at regular intervals.

### General maintenance

General maintenance includes those items which should be checked during normal day-to-day operation. They are essential for proper vehicle operation. It is your responsibility to perform these maintenance procedures regularly as prescribed.

## 8-2 Maintenance and do-it-yourself

Performing general maintenance checks requires minimal mechanical skill and only a few general automotive tools.

These checks or inspections can be done by you, a qualified technician, or, if you prefer, a NISSAN dealer.

### Where to go for service

If maintenance service is required or your vehicle appears to malfunction, have the systems checked and corrected by a NISSAN dealer.

NISSAN technicians are well-trained specialists who are kept up-to-date with the latest service information through technical bulletins, service tips and in-dealership training programs. They are completely qualified to work on NISSAN vehicles **before** they work on your vehicle rather than after they have worked on it.

You can be confident that a NISSAN dealer's service department performs the best job to meet the maintenance requirements on your vehicle — in a reliable and economical way.

## GENERAL MAINTENANCE

During the normal day-to-day operation of the vehicle, general maintenance should be performed regularly as prescribed in this section. If you detect any unusual sounds, vibrations or smells, be sure to check for the cause or have a NISSAN dealer do it promptly. In addition, you should notify a NISSAN dealer if you think that repairs are required.

When performing any checks or maintenance work, closely observe the "Maintenance precautions" in this section.

## EXPLANATION OF GENERAL MAINTENANCE ITEMS

**Additional information on the following items with " \* " is found in this section.**

### Outside the vehicle

The maintenance items listed here should be performed from time to time, unless otherwise specified.

**Doors and engine hood** Check that the doors and engine hood operate properly. Also ensure that all latches lock securely. Lubricate hinges, latches, latch pins, rollers and links as necessary. Make sure that the secondary latch keeps the hood from opening when the primary latch is released.

When driving in areas using road salt or other corrosive materials, check lubrication frequently.

**Lights\*** Clean the headlights on a regular basis. Make sure that the headlights, stop lights, tail lights, turn signal lights, and other lights are all operating properly and installed securely. Also check headlight aim.

**Road wheel nuts (lug nuts)\*** When checking the tires, make sure no wheel nuts are missing, and check for any loose wheel nuts. Tighten if necessary.

**Tire rotation\*** Tires should be rotated every 7,500 miles (12,000 km).

**Tires\*** Check the pressure with a gauge often and always prior to long distance trips. If necessary, adjust the pressure in all tires, including the spare, to the pressure specified. Check carefully for damage, cuts or excessive wear.

**Tire Pressure Monitoring System (TPMS) transmitter components** Replace the TPMS transmitter grommet seal, valve core and cap when the tires are replaced due to wear or age.

**Wheel alignment and balance** If the vehicle should pull to either side while driving on a straight and level road, or if you detect uneven or abnormal tire wear, there may be a need for wheel

alignment. If the steering wheel or seat vibrates at normal highway speeds, wheel balancing may be needed.

- For additional information regarding tires, refer to “Important Tire Safety Information” (US) or “Tire Safety Information” (Canada) in the Warranty Information Booklet.

**Windshield** Clean the windshield on a regular basis. Check the windshield at least every six months for cracks or other damage. Have a damaged windshield repaired by a qualified repair facility.

**Windshield wiper blades\*** Check for cracks or wear if they do not wipe properly.

### Inside the vehicle

The maintenance items listed here should be checked on a regular basis, such as when performing periodic maintenance, cleaning the vehicle, etc.

**Additional information on the following items with an “\*” is found in this section.**

**Accelerator pedal** Check the pedal for smooth operation and make sure the pedal does not bind or require uneven effort. Keep the floor mat away from the pedal.

**Brake pedal** Check the pedal for smooth operation. If the brake pedal suddenly goes down further than normal, the pedal feels spongy or the vehicle seems to take longer to stop, see a NISSAN dealer immediately. Keep the floor mat away from the pedal.

**Brakes** Check that the brakes do not pull the vehicle to one side when applied.

**Continuously Variable Transmission (CVT) P (Park) position mechanism** On a fairly steep hill check that your vehicle is held securely with the shift lever in the P (Park) position without applying any brakes.

**Parking brake** Check the parking brake operation regularly. The vehicle should be securely held on a fairly steep hill with only the parking brake applied. If the parking brake needs adjustment, see a NISSAN dealer.

**Seats** Check seat position controls such as seat adjusters, seatback recliner, etc. to ensure they operate smoothly and all latches lock securely in every position. Check that the head restraints/headrests move up and down smoothly and the locks (if so equipped) hold securely in all latched positions.

**Seat belts** Check that all parts of the seat belt system (for example, buckles, anchors, adjusters and retractors) operate properly and smoothly, and are installed securely. Check the belt webbing for cuts, fraying, wear or damage.

**Steering wheel** Check for changes in the steering system, such as excessive freeplay, hard steering or strange noises.

**Warning lights and chimes** Make sure all warning lights and chimes are operating properly.

**Windshield wiper and washer\*** Check that the wipers and washer operate properly and that the wipers do not streak.

**Windshield defroster** Check that the air comes out of the defroster outlets properly and in sufficient quantity when operating the heater or air conditioner.

## Under the hood and vehicle

The maintenance items listed here should be checked periodically (for example, each time you check the engine oil or refuel).

**Battery\*** Check the fluid level in each cell. It should be between the MAX and MIN lines. Vehicles operated in high temperatures or under severe conditions require frequent checks of the battery fluid level.

## 8-4 Maintenance and do-it-yourself

### NOTE:

**Care should be taken to avoid situations that can lead to potential battery discharge and potential no-start conditions such as:**

- 1. Installation or extended use of electronic accessories that consume battery power when the engine is not running (Phone chargers, GPS, DVD players, etc.)**
- 2. Vehicle is not driven regularly and/or only driven short distances. In these cases, the battery may need to be charged to maintain battery health.**

**Brake fluid level\*** Make sure that the brake fluid level is between the MIN and MAX lines on the reservoir.

**Engine coolant level\*** Check the coolant level when the engine is cold.

**Engine drive belts\*** Make sure the drive belts are not frayed, worn, cracked or oily.

**Engine oil level\*** Check the level after parking the vehicle on a level surface with the engine off. Wait more than 10 minutes for the oil to drain back into the oil pan.

**Exhaust system** Make sure there are no loose supports, cracks or holes. If the sound of the exhaust seems unusual or there is a smell of exhaust fumes, immediately have the exhaust system inspected by a NISSAN dealer. See the

carbon monoxide warning in the “Starting and driving” section of this manual.

**Fluid leaks** Check under the vehicle for fuel, oil, water or other fluid leaks after the vehicle has been parked for a while. Water dripping from the air conditioner after use is normal. If you should notice any leaks or if gasoline fumes are evident, check for the cause and have it corrected immediately.

**Radiator and hoses** Check the front of the radiator and clean off any dirt, insects, leaves, etc., that may have accumulated. Make sure the hoses have no cracks, deformation, rot or loose connections.

**Underbody** The underbody is frequently exposed to corrosive substances such as those used on icy roads or to control dust. It is very important to remove these substances from the underbody, otherwise rust may form on the floor pan, frame, fuel lines and exhaust system. At the end of winter, the underbody should be thoroughly flushed with plain water, in those areas where mud and dirt may have accumulated. See the “Appearance and care” section of this manual.

**Windshield-washer fluid\*** Check that there is adequate fluid in the reservoir.

## MAINTENANCE PRECAUTIONS

When performing any inspection or maintenance work on your vehicle, always take care to prevent serious accidental injury to yourself or damage to the vehicle. The following are general precautions which should be closely observed.

### WARNING

- **Park the vehicle on a level surface, apply the parking brake securely and block the wheels to prevent the vehicle from moving. Move the shift lever to P (Park).**
- **Be sure the ignition switch is in the OFF or LOCK position when performing any parts replacement or repairs.**
- **If you must work with the engine running, keep your hands, clothing, hair and tools away from moving fans, belts and any other moving parts.**
- **It is advisable to secure or remove any loose clothing and remove any jewelry, such as rings, watches, etc. before working on your vehicle.**
- **Always wear eye protection whenever you work on your vehicle.**

- **Your vehicle is equipped with an automatic engine cooling fan. It may come on at any time without warning, even if the ignition switch is in the OFF position and the engine is not running. To avoid injury, always disconnect the negative battery cable before working near the fan.**
- **If you must run the engine in an enclosed space such as a garage, be sure there is proper ventilation for exhaust gases to escape.**
- **Never get under the vehicle while it is supported only by a jack. If it is necessary to work under the vehicle, support it with safety stands.**
- **Keep smoking materials, flame and sparks away from the fuel tank and battery.**
- **The fuel filter or fuel lines should be serviced by a NISSAN dealer because the fuel lines are under high pressure even when the engine is off.**

### CAUTION

- **Do not work under the hood while the engine is hot. Turn the engine off and wait until it cools down.**
- **Avoid contact with used engine oil and coolant. Improperly disposed engine oil, engine coolant and/or other vehicle fluids can damage the environment. Always conform to local regulations for disposal of vehicle fluid.**
- **Never leave the engine or continuously variable transmission related component harnesses disconnected while the ignition switch is in the ON position.**
- **Never connect or disconnect the battery or any transistorized component while the ignition switch is in the ON position.**

This "Maintenance and do-it-yourself" section gives instructions regarding only those items which are relatively easy for an owner to perform.

You should be aware that incomplete or improper servicing may result in operating difficulties or excessive emissions, and could affect warranty coverage. **If in doubt about any servicing, have it done by a NISSAN dealer.**

## ENGINE COMPARTMENT CHECK LOCATIONS

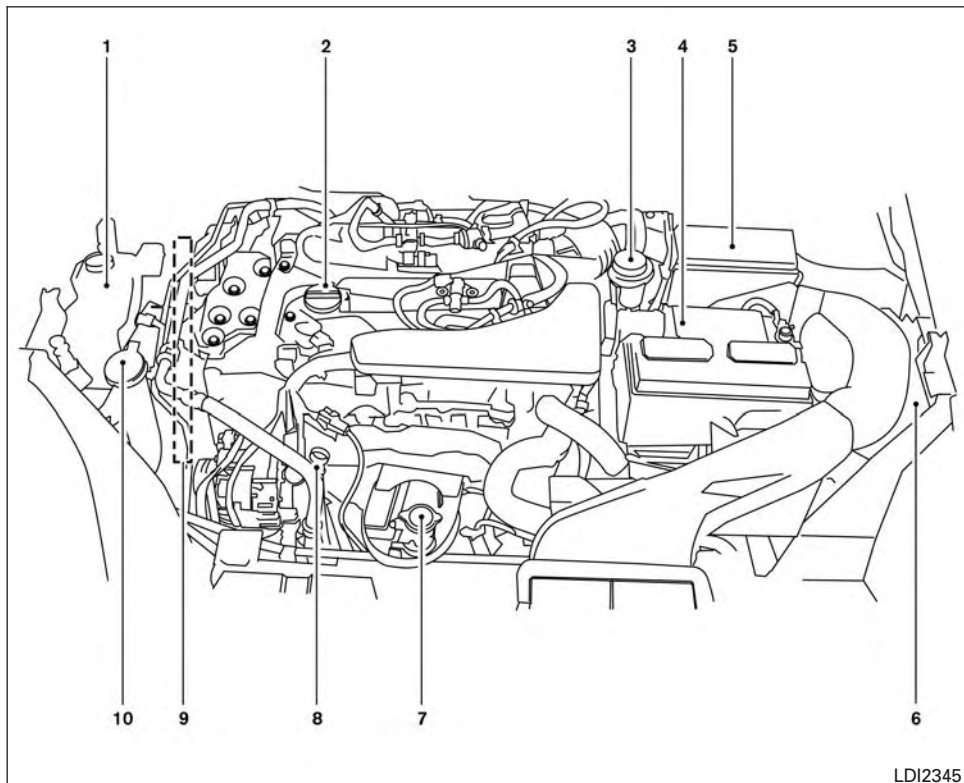

### QR25DE engine

1. Engine coolant reservoir
2. Engine oil filler cap
3. Brake fluid reservoir
4. Battery
5. Air cleaner
6. Fuse/Fusible link box
7. Radiator cap
8. Engine oil dipstick
9. Drive belt location
10. Windshield-washer fluid reservoir

\* **Engine cover removed for clarity.**

LDI2345

## ENGINE COOLING SYSTEM

The engine cooling system is filled at the factory with a pre-diluted mixture of 50% Genuine NISSAN Long Life Antifreeze/Coolant (blue) and 50% water to provide year-round anti-freeze and coolant protection. The antifreeze solution contains rust and corrosion inhibitors. Additional engine cooling system additives are not necessary.

### WARNING

- **Never remove the radiator or coolant reservoir cap when the engine is hot. Wait until the engine and radiator cool down. Serious burns could be caused by high pressure fluid escaping from the radiator. See precautions in “If your vehicle overheats” found in the “In case of emergency” section of this manual.**
- **The radiator is equipped with a pressure type radiator cap. To prevent engine damage, use only a genuine NISSAN radiator cap.**

### CAUTION

- **Never use any cooling system additives such as radiator sealer. Additives may clog the cooling system and cause damage to the engine, transmission and/or cooling system.**
- **When adding or replacing coolant, be sure to use only Genuine NISSAN Long Life Antifreeze/Coolant (blue) or equivalent. Genuine NISSAN Long Life Antifreeze/Coolant (blue) is pre-diluted to provide antifreeze protection to -34° F (-37° C). If additional freeze protection is needed due to weather where you operate your vehicle, add Genuine NISSAN Long Life Antifreeze/Coolant (blue) concentrate following the directions on the container. If an equivalent coolant other than Genuine NISSAN Long Life Antifreeze/Coolant (blue) is used, follow the coolant manufacturer's instructions to maintain minimum anti-freeze protection to -34° F (-37° C). The use of other types of coolant solutions other than Genuine NISSAN Long Life Antifreeze/Coolant (blue) or equivalent may damage the engine cooling system.**

- **The life expectancy of the factory-fill coolant is 105,000 miles (168,000 km) or 7 years. Mixing any other type of coolant other than Genuine NISSAN Long Life Antifreeze/Coolant (blue), including Genuine NISSAN Long Life Antifreeze/Coolant (green), or the use of non-distilled water will reduce the life expectancy of the factory-fill coolant. Refer to the NISSAN Service and Maintenance Guide for more details.**

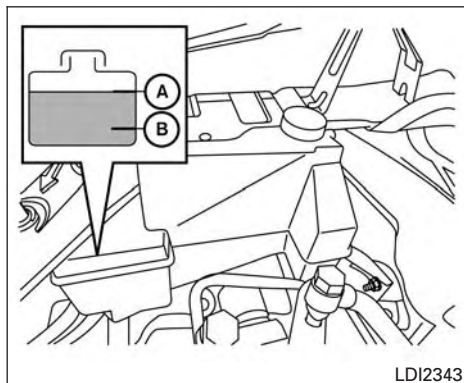

This vehicle contains Genuine NISSAN Long Life Antifreeze/Coolant (blue). The life expectancy of the factory-fill coolant is 105,000 miles (168,000 km) or 7 years. Mixing any other type of coolant or the use of non-distilled water will reduce the life expectancy of the factory-fill coolant. Refer to the NISSAN Service and Maintenance Guide for more details.

**The engine coolant reservoir is a pressurized tank. When installing the cap, tighten it until a clicking sound is heard.**

**If the cooling system frequently requires coolant, have it checked by a NISSAN dealer.**

## CHANGING ENGINE COOLANT

A NISSAN dealer can change the engine coolant. The service procedure can be found in the NISSAN Service Manual.

**Improper servicing can result in reduced heater performance and engine overheating.**

## CHECKING ENGINE COOLANT LEVEL

Check the coolant level **in the reservoir when the engine is cold**. If the coolant level is below the MIN level (B), add coolant to the MAX level (A). If the reservoir is empty, check the coolant level in the radiator **when the engine is cold**. If there is insufficient coolant in the radiator, fill the radiator with coolant up to the filler opening and also add it to the reservoir up to the MAX level (A).

## WARNING

- **To avoid the danger of being scalded, never change the coolant when the engine is hot.**
- **Never remove the radiator or engine coolant reservoir cap when the engine is hot. Serious burns could be caused by high pressure fluid escaping from the radiator.**
- **Avoid direct skin contact with used coolant. If skin contact is made, wash thoroughly with soap or hand cleaner as soon as possible.**
- **Keep coolant out of the reach of children and pets.**

Engine coolant must be disposed of properly. Check your local regulations.

## ENGINE OIL

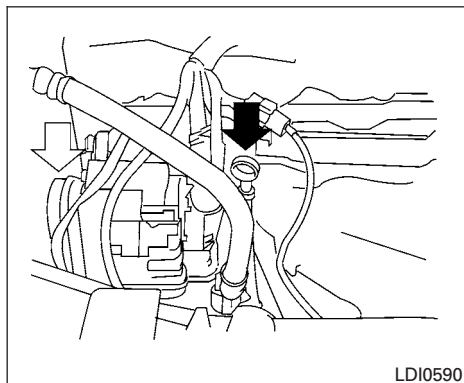

### CHECKING ENGINE OIL LEVEL

1. Park the vehicle on a level surface and apply the parking brake.
2. Start the engine and let it idle until it reaches operating temperature.
3. Turn off the engine. **Wait more than 10 minutes for the oil to drain back into the oil pan.**
4. Remove the dipstick and wipe it clean. Reinsert it all the way.

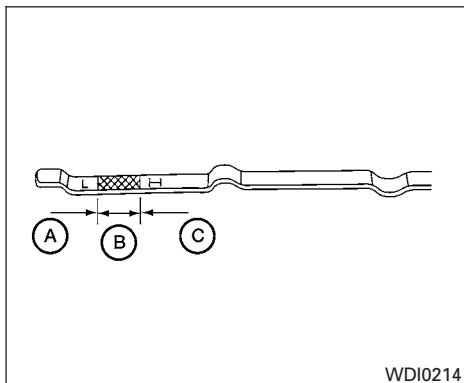

5. Remove the dipstick again and check the oil level. It should be between the H (High) and L (Low) marks **(B)**. This is the normal operating oil level range. If the oil level is below the L (Low) mark **(A)**, remove the oil filler cap and pour recommended oil through the opening. **Do not overfill (C)**.
6. Recheck oil level with the dipstick.

**It is normal to add some oil between oil maintenance intervals or during the break-in period, depending on the severity of operating conditions.**

### CAUTION

**Oil level should be checked regularly. Operating the engine with an insufficient amount of oil can damage the engine, and such damage is not covered by warranty.**



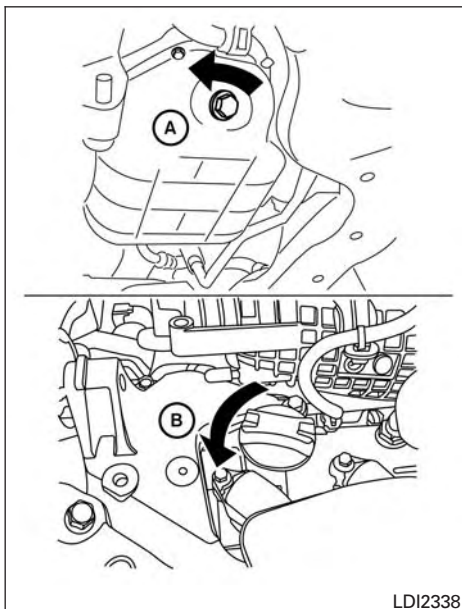

LDI2338

## CHANGING ENGINE OIL

1. Park the vehicle on a level surface and apply the parking brake.
2. Start the engine and let it idle until it reaches operating temperature, then turn it off.

## 8-10 Maintenance and do-it-yourself

3. Remove the oil filler cap (B) by turning it counterclockwise.
4. Place a large drain pan under the drain plug (A).
5. Remove the drain plug (A) with a wrench by turning it counterclockwise and completely drain the oil.

If the oil filter is to be changed, remove and replace it at this time. See “Changing engine oil filter” in this section.

- **Waste oil must be disposed of properly.**
- **Check your local regulations.**

### ⚠ WARNING

- **Prolonged and repeated contact with used engine oil may cause skin cancer.**
- **Try to avoid direct skin contact with used oil. If skin contact is made, wash thoroughly with soap or hand cleaner as soon as possible.**
- **Keep used engine oil out of reach of children.**

### ⚠ CAUTION

**Be careful not to burn yourself. The engine oil may be hot.**

6. Clean and reinstall the drain plug and a new washer. Securely tighten the drain plug with a wrench. Do not use excessive force.

**Drain plug tightening torque:  
22 - 29 ft-lb (29 - 39 N-m)**

7. Refill engine with recommended oil through the oil filler opening, then install the oil filler cap securely.

See “Recommended fluids/lubricants and capacities” in the “Technical and consumer information” section of this manual for drain and refill capacity.

The drain and refill capacity depends on the oil temperature and drain time. Use these specifications for reference only. Always use the dipstick to determine when the proper amount of oil is in the engine.

8. Start the engine. Check for leakage around the drain plug and oil filter. Correct as required.
9. Turn the engine off and wait more than 10 minutes. Check the oil level with the dipstick. Add engine oil if necessary.

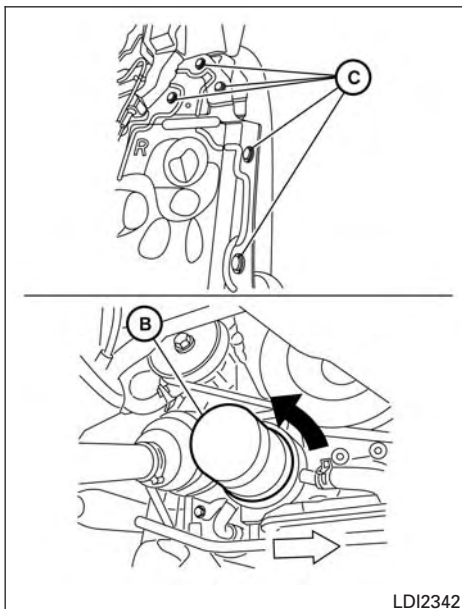

## CHANGING ENGINE OIL FILTER

1. Park the vehicle on a level surface and apply the parking brake.
2. Turn the engine off.
3. Place a large drain pan under the oil filter (B).

4. Remove pins (C) from the right engine protector located inside right wheel well, remove protector. Remove oil filter (B) with an oil filter wrench by turning it counterclockwise. Then remove the oil filter by turning it by hand.

### **⚠ CAUTION**

**Be careful not to burn yourself. The engine oil may be hot.**

5. Wipe the engine oil filter sealing surface with a clean rag.

### **⚠ CAUTION**

- **Be sure to remove any old gasket material remaining on the sealing surface of the engine. Failure to do so could lead to an oil leak and engine damage.**
- **The dipstick must be inserted in place to prevent oil spillage from the dipstick hole when filling the engine with oil.**

6. Coat the gasket on the new filter with clean engine oil.
7. Screw on the oil filter until a slight resistance is felt, then tighten an additional 2/3 turn.

8. Start the engine and check for leakage around the oil filter. Correct as required.
9. Turn the engine off and wait more than 10 minutes. Check the oil level. Add engine oil if necessary.

## CONTINUOUSLY VARIABLE TRANSMISSION (CVT) FLUID

### ⚠ CAUTION

- Use only Genuine NISSAN CVT Fluid NS-3. Do not mix with other fluids.
- Using transmission fluid other than Genuine NISSAN CVT Fluid NS-3 will damage the CVT, which is not covered by the warranty.

When checking or replacement of CVT fluid is required, we recommend your NISSAN dealer for servicing.

## BRAKE FLUID

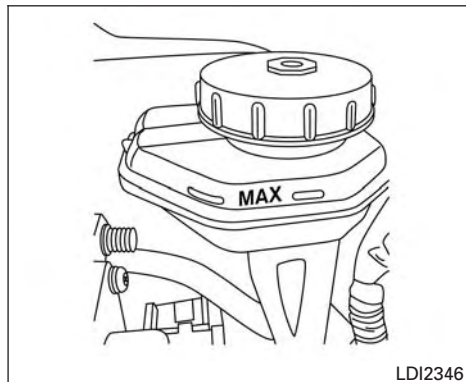

Check the brake fluid level in the reservoir. If the brake warning light comes on, add Genuine NISSAN Super Heavy Duty Brake Fluid or equivalent **DOT 3** fluid up to the MAX line. If fluid must be added frequently, the system should be checked by a NISSAN dealer.

## WINDSHIELD-WASHER FLUID

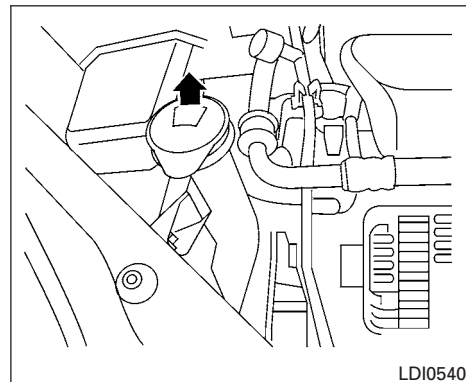

### WINDSHIELD-WASHER FLUID RESERVOIR

Fill the windshield-washer fluid reservoir periodically. Add windshield-washer fluid when the low windshield-washer fluid warning light comes on.

To fill the windshield-washer fluid reservoir, lift the cap off the reservoir and pour the windshield-washer fluid into the reservoir opening.

Add a washer solvent to the washer for better cleaning. In the winter season, add a windshield washer antifreeze. Follow the manufacturer's instructions for the mixture ratio.

Refill the reservoir more frequently when driving conditions require an increased amount of windshield-washer fluid.

Recommended fluid is Genuine NISSAN Windshield Washer Concentrate Cleaner & Antifreeze or equivalent.

### CAUTION

- Do not substitute engine antifreeze coolant for windshield-washer fluid. This may result in damage to the paint.
- Do not fill the windshield-washer fluid reservoir with washer fluid concentrates at full strength. Some methyl alcohol based washer fluid concentrates may permanently stain the grille if spilled while filling the windshield-washer fluid reservoir.
- Pre-mix washer fluid concentrates with water to the manufacturer's recommended levels before pouring the fluid into the windshield-washer fluid reservoir. Do not use the windshield-washer fluid reservoir to mix the washer fluid concentrate and water.

## BATTERY

- Keep the battery surface clean and dry. Clean the battery with a solution of baking soda and water.
- Make certain the terminal connections are clean and securely tightened.
- If the vehicle is not to be used for 30 days or longer, disconnect the negative (-) battery terminal cable to prevent discharge.

### NOTE:

Care should be taken to avoid situations that can lead to potential battery discharge and potential no-start conditions such as: 1. Installation or extended use of electronic accessories that consume battery power when the engine is not running (Phone chargers, GPS, DVD players, etc.) 2. Vehicle is not driven regularly and/or only driven short distances. In these cases, the battery may need to be charged to maintain battery health.

### WARNING

- Do not expose the battery to flames, an electrical spark or a cigarette. Hydrogen gas generated by the battery is explosive. Explosive gases can cause blindness or injury. Do not allow battery fluid to contact your skin, eyes, fabrics or painted surfaces. Sulfuric acid can cause blindness or injury. After touching a battery or battery cap, do not touch or rub your eyes. Thoroughly wash your hands. If the acid contacts your eyes, skin or clothing, immediately flush with water for at least 15 minutes and seek medical attention.
- Do not operate the vehicle if the fluid in the battery is low. Low battery fluid can cause a higher load on the battery which can generate heat, reduce battery life, and in some cases lead to an explosion.
- When working on or near a battery, always wear suitable eye protection and remove all jewelry.
- Battery posts, terminals and related accessories contain lead and lead compounds. Wash hands after handling.

- Keep battery out of the reach of children.
- Do not tip the battery. Keep the vent caps tight and the battery level.

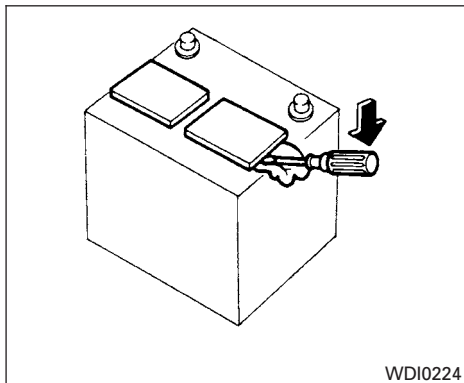

1. Remove the vent caps with a screwdriver as shown. Use a cloth to protect the battery case.

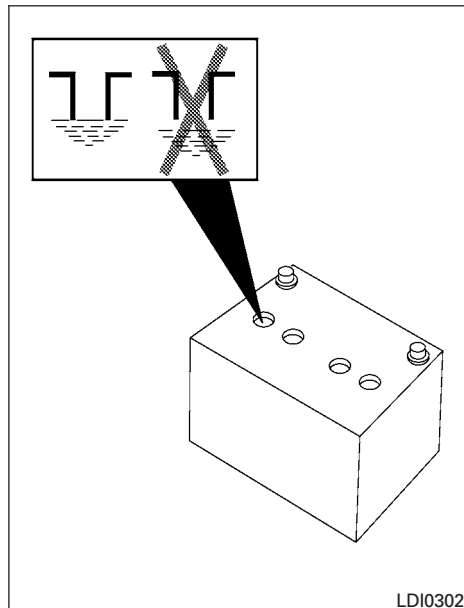

2. Check the fluid level in each cell. If it is necessary to add fluid, add only distilled water to bring the level up to the bottom of the filler opening. **Do not overfill.** Reinstall the vent caps.

## VARIABLE VOLTAGE CONTROL SYSTEM

Vehicles operated in high temperatures or under severe conditions require frequent checks of the battery fluid level.

### JUMP STARTING

If jump starting is necessary, see “Jump starting” in the “In case of emergency” section of this manual. If the engine does not start by jump starting, the battery may have to be replaced. Contact a NISSAN dealer.

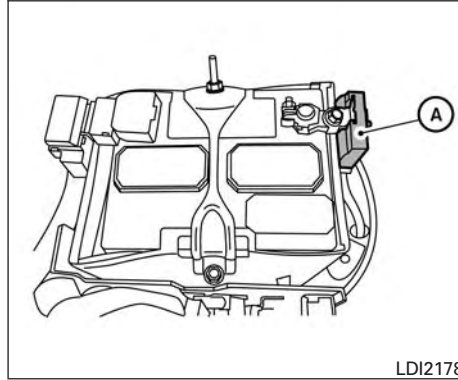

Your vehicle is equipped with a variable voltage control system. This system measures the amount of electrical discharge from the battery and controls voltage generated by the generator.

The current sensor (A) is located near the battery along the negative battery cable. If you add electrical accessories to your vehicle, be sure to ground them to a suitable body ground such as the frame or engine block area.

### ⚠ CAUTION

- Do not ground accessories directly to the battery terminal. Doing so will bypass the variable voltage control system and the vehicle battery may not charge completely.
- Use electrical accessories with the engine running to avoid discharging the vehicle battery.

## DRIVE BELT

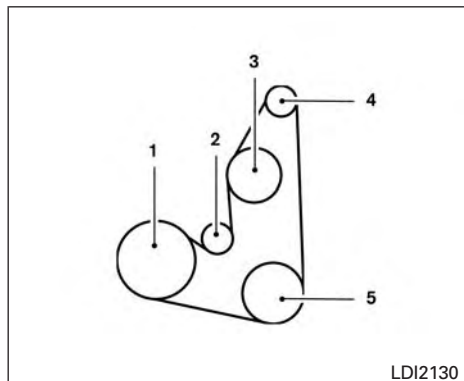

QR25DE engine

1. Crankshaft pulley
2. Drive belt Automatic tensioner
3. Water pump pulley
4. Alternator
5. Air conditioner

### WARNING

Be sure the ignition switch is placed in the **OFF** or **LOCK** position before servicing drive belt. The engine could rotate unexpectedly.

1. Visually inspect the belt for signs of unusual wear, cuts, fraying or looseness. If the belt is in poor condition or is loose, have it replaced or adjusted by a NISSAN dealer.
2. Have the belt checked regularly for condition and tension in accordance with the maintenance schedule found in the "NISSAN Service and Maintenance Guide".

## SPARK PLUGS

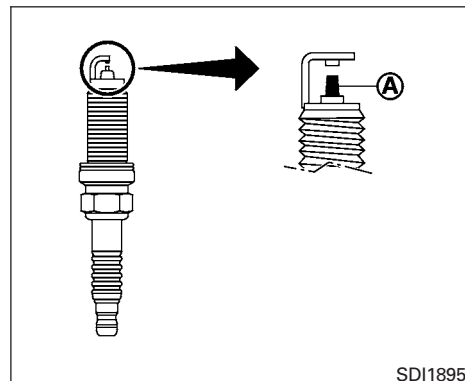

## REPLACING SPARK PLUGS

### Iridium-tipped spark plugs

It is not necessary to replace iridium-tipped **(A)** spark plugs as frequently as conventional type spark plugs because they last much longer. Follow the maintenance log shown in the "NISSAN Service and Maintenance Guide". Do not service iridium-tipped spark plugs by cleaning or regapping.

- **Always replace spark plugs with recommended or equivalent ones.**

## AIR CLEANER

### **⚠ WARNING**

Be sure the engine and ignition switch are off and that the parking brake is engaged securely.

### **⚠ CAUTION**

Be sure to use the correct socket to remove the spark plugs. An incorrect socket can damage the spark plugs.

If replacement is required, see your NISSAN dealer for assistance.

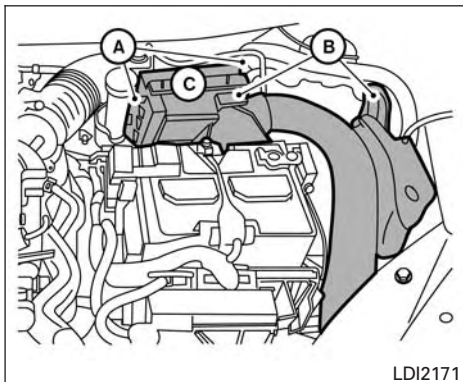

The air cleaner filter should not be cleaned and reused. Replace it according to the maintenance log shown in the "NISSAN Service and Maintenance Guide."

To remove the air cleaner filter:

1. Unlatch the retaining clips **(A)**.
2. Pull up at points **(B)** and remove.
3. Pull up and remove air cleaner housing **(C)**.
4. Remove the air cleaner filter, Wipe the inside of the air cleaner filter housing and the cover with a damp cloth, then replace air cleaner filter.

### **NOTE:**

After installing a new air cleaner, make sure the air cleaner cover is seated in the housing and latch the clips.

### **⚠ WARNING**

- Operating the engine with the air cleaner removed can cause you or others to be burned. The air cleaner not only cleans the air, it stops the flame if the engine backfires. If it isn't there, and the engine backfires, you could be burned. Do not drive with the air cleaner removed, and be careful when working on the engine with the air cleaner removed.
- Never pour fuel into the throttle body or attempt to start the engine with the air cleaner removed. Doing so could result in serious injury.



## WINDSHIELD WIPER BLADES

### IN-CABIN MICROFILTER

The in-cabin microfilter restricts the entry of air-borne dust and pollen particles and reduces some objectionable outside odors. The filter is located behind the glove box. Refer to the "NISSAN Service and Maintenance Guide" for change intervals.

If replacement is required, see your NISSAN dealer.

### CLEANING

If your windshield is not clear after using the windshield washer or if a wiper blade chatters when running, wax or other material may be on the blade or windshield.

Clean the outside of the windshield with a washer solution or a mild detergent. Your windshield is clean if beads do not form when rinsing with clear water.

Clean each blade by wiping it with a cloth soaked in a washer solution or a mild detergent. Then rinse the blades with clear water. If your windshield is still not clear after cleaning the blades and using the wiper, replace the blades.

#### CAUTION

**Worn windshield wiper blades can damage the windshield and impair driver vision.**

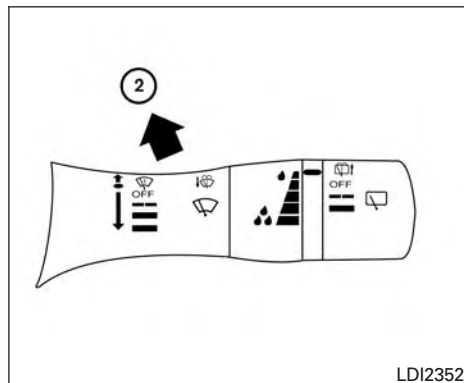

LDI2352

### REPLACING

Replace the wiper blades if they are worn.

To replace the windshield wiper blades, follow the procedure below:

1. When ignition switch is ON or within 60 seconds after placing the ignition switch from ON to OFF position.
2. Quickly push the windshield wiper and washer lever to the mist position twice (2) within 0.5 seconds. This action will cause the wipers to take the service position automatically.
3. Lift the wiper arm away from the windshield.

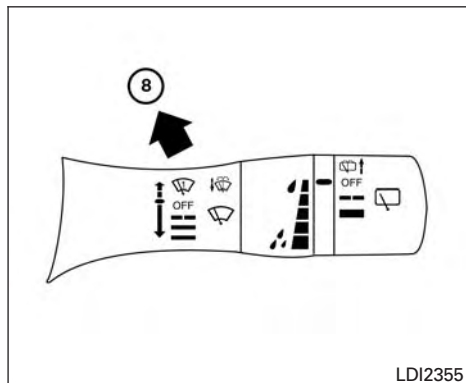
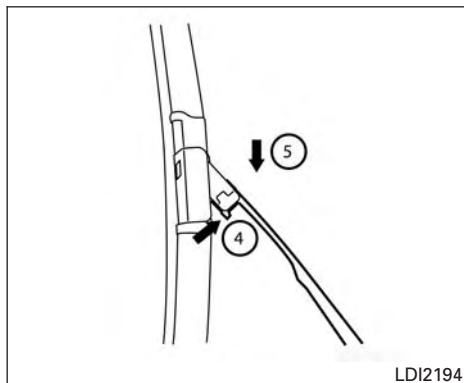

4. Push the release tab (4).
5. Move the wiper blade down (5) and remove.
6. Insert the new wiper blade onto the wiper arm until it clicks into place.
7. Rotate the wiper blade so the dimple is in the groove.
8. Finally, push the windshield wiper and washer lever to the mist position (8). This action will cause the wipers to resume the set position.

#### **CAUTION**

- After wiper blade replacement, return the wiper arm to its original position; otherwise it may be damaged when the hood is opened.
- Make sure the wiper blades contact the glass; otherwise the arms may be damaged from wind pressure.

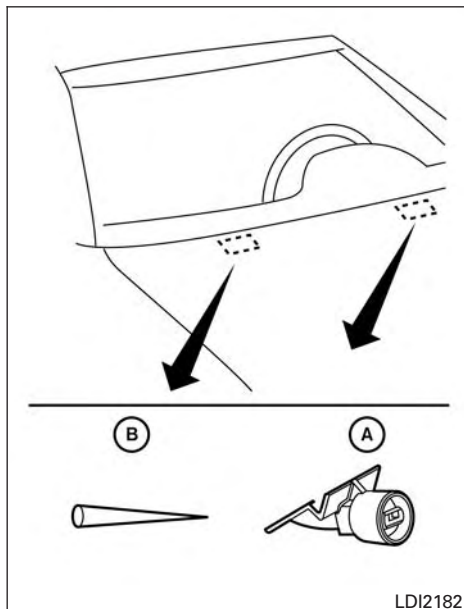

### Rear window wiper blade

Contact a NISSAN dealer if checking or replacement is required.

If you wax the surface of the hood, be careful not to let wax get into the washer nozzle (A). This may cause clogging or improper windshield-washer operation. If wax gets into the nozzle, remove it with a needle or small pin (B).

## BRAKES

If the brakes do not operate properly, have the brakes checked by a NISSAN dealer.

### Self-adjusting brakes

Your vehicle is equipped with self-adjusting brakes.

The front and rear disc-type brakes self-adjust every time the brake pedal is applied.

#### **⚠ WARNING**

**See a NISSAN dealer for a brake system check if the brake pedal height does not return to normal.**

### Brake pad wear indicators

The disc brake pads on your vehicle have audible wear indicators. When a brake pad requires replacement, a high pitched scraping or screeching sound will be heard when the vehicle is in motion. The noise will be heard whether or not the brake pedal is depressed. Have the brakes checked as soon as possible if the wear indicator sound is heard.

Under some driving or climate conditions, occasional brake squeak, squeal or other noise may be heard. Occasional brake noise during light to moderate stops is normal and does not affect the function or performance of the brake system.

## FUSES

**Proper brake inspection intervals should be followed.** For more information regarding brake inspections, see the appropriate maintenance schedule information in the “NISSAN Service and Maintenance Guide”.

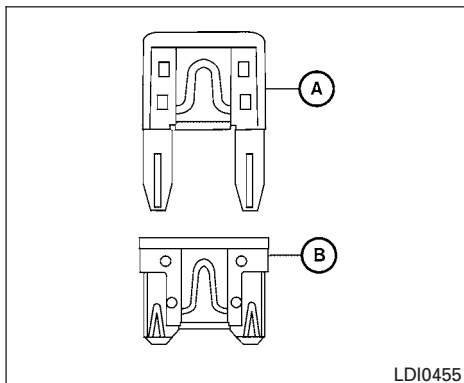

Two types of fuses are used. Type **A** is used in the fuse boxes in the engine compartment. Type **B** is used in the passenger compartment fuse box.

Type A fuses are provided as spare fuses. They are stored in the passenger compartment fuse box.

Type A fuses can be installed in the engine compartment and passenger compartment fuse boxes.

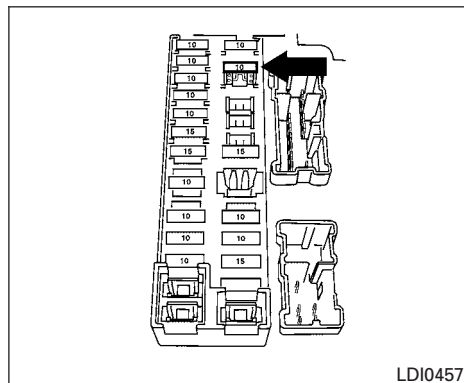

If a type A fuse is used to replace a type B fuse, the type A fuse will not be level with the fuse pocket as shown in the illustration. This will not affect the performance of the fuse. Make sure the fuse is installed in the fuse box securely.

Type B fuses cannot be installed in the underhood fuse boxes. Only use type A fuses in the underhood fuse boxes.

## ENGINE COMPARTMENT

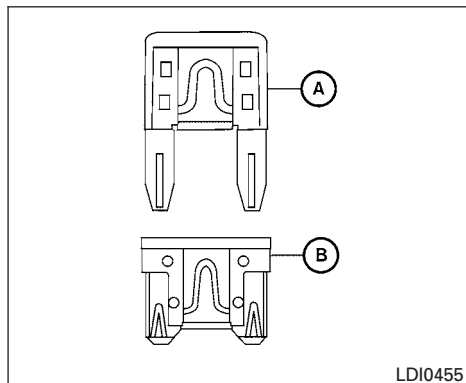

### **⚠ CAUTION**

**Never use a fuse of a higher or lower amperage rating than specified on the fuse box cover. This could damage the electrical system or cause a fire.**

Two types of fuses are used. Type **A** is used in the fuse boxes in the engine compartment. Type **B** is used in the passenger compartment fuse box.

Type A fuses are provided as spare fuses. They are stored in the passenger compartment fuse box.

Type A fuses can be installed in the engine compartment and passenger compartment fuse boxes.

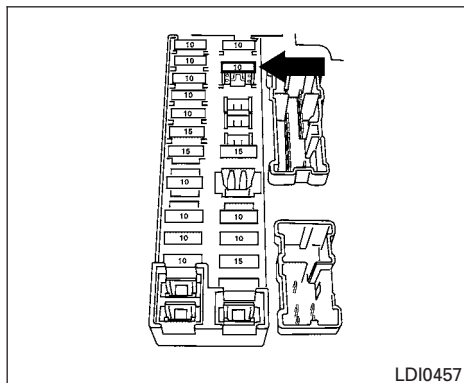

If a type A fuse is used to replace a type B fuse, the type A fuse will not be level with the fuse pocket as shown in the illustration. This will not affect the performance of the fuse. Make sure the fuse is installed in the fuse box securely.

Type B fuses cannot be installed in the underhood fuse boxes. Only use type A fuses in the underhood fuse boxes.

### Fusible links

If the electrical equipment does not operate and fuses are in good condition, check the fusible links. If any of these fusible links are melted, replace with only Genuine NISSAN parts.

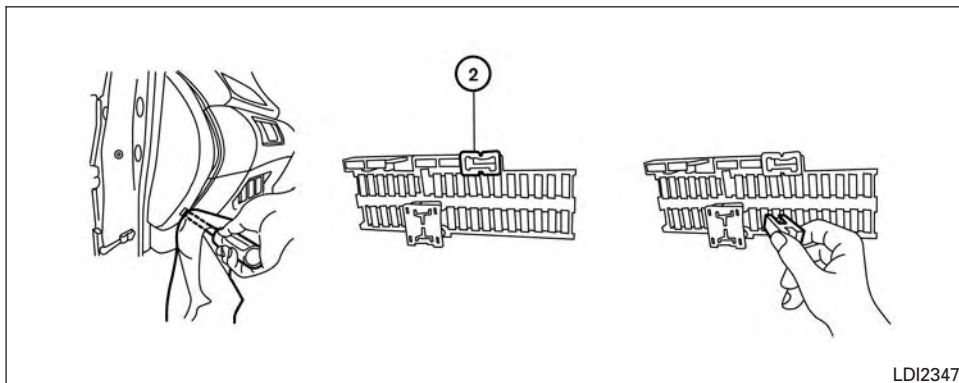

### PASSENGER COMPARTMENT

#### **CAUTION**

**Never use a fuse of a higher or lower amperage rating than specified on the fuse box cover. This could damage the electrical system or cause a fire.**

If any electrical equipment does not operate, check for an open fuse.

#### **NOTE:**

**The fuse box is located on the driver's side of the instrument panel.**

1. Be sure the ignition switch and the headlight switch are OFF.
2. Remove the fuse box cover with a suitable tool. Use a cloth to avoid damaging the trim.
3. Locate the fuse that needs to be replaced.
4. Remove the fuse with the fuse puller ②.

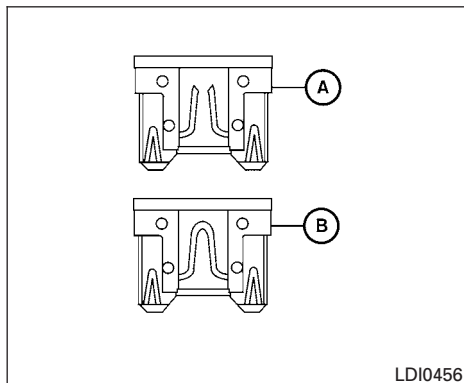

5. If the fuse is open (A), replace it with an equivalent good fuse (B).
6. Push the fuse box cover to install.

If a new fuse also opens, have the electrical system checked and repaired by a NISSAN dealer.

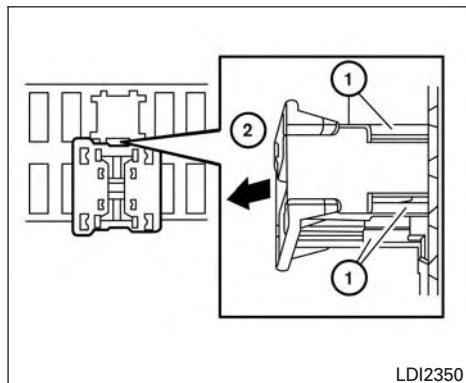

### Extended storage switch

If any electrical equipment does not operate, remove the extended storage switch and check for an open fuse.

#### NOTE:

**The extended storage switch is used for long term vehicle storage. Even if the extended storage switch is broken it is not necessary to replace it. Replace only the open fuse in the switch with a new fuse.**

How to replace the extended storage switch:

1. To remove the extended storage switch, be sure the ignition switch is in the OFF or LOCK position.
2. Be sure the headlight switch is in the OFF position.
3. Remove the fuse box cover.
4. Pinch the locking tabs ① found on each side of the storage switch.
5. Pull the storage switch straight out from the fuse box ②.

## BATTERY REPLACEMENT

### CAUTION

Be careful not to allow children to swallow the battery or removed parts.

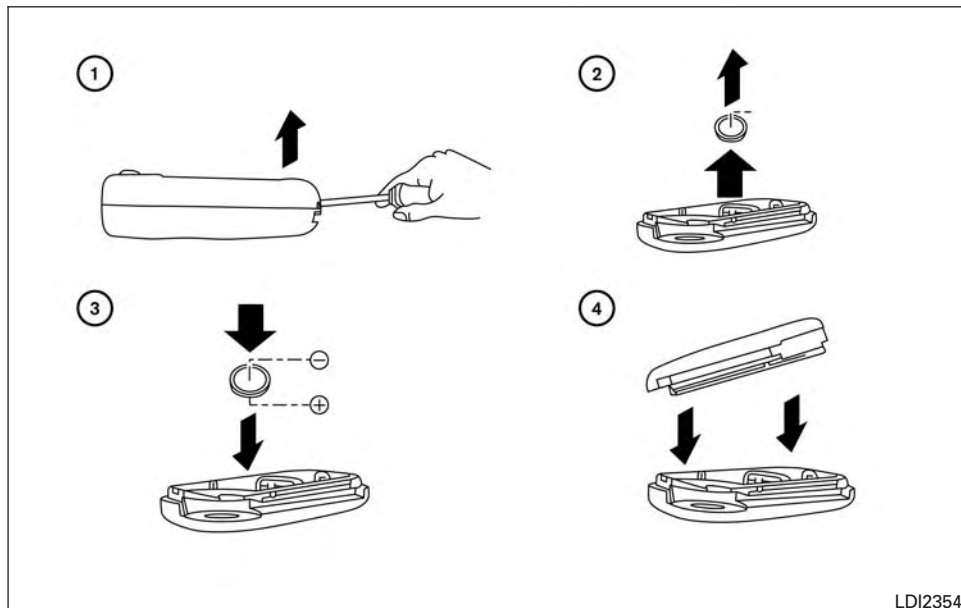

### NISSAN JACKKNIFE KEY (if so equipped)

Replace the battery in the jackknife key as follows:

- ① Hold jackknife key button side up. Insert a small screwdriver into the slit of the corner and twist it to separate the upper part from the lower part. Use a cloth to protect the casing.
- ② Remove old battery.



- ③ Replace the battery with a new one.

Recommended battery: CR2032 or equivalent.

- Do not touch the internal circuit and electric terminals as doing so could cause a malfunction.
- Hold the battery by the edges. Holding the battery across the contact points will seriously deplete the storage capacity.

- ④ Close lid securely as illustrated.

Operate the buttons to check the operation.

See a NISSAN dealer if you need assistance for replacement.

**NOTE:**

**Changes or modifications not expressly approved by the party responsible for compliance could void the user's authority to operate the equipment.**

**NISSAN INTELLIGENT KEY® (if so equipped)**

Replace the battery in the Intelligent Key as follows:

1. Remove the mechanical key from the Intelligent Key.
2. Insert a small screwdriver (A) into the slit (B) of the corner and twist it to separate the upper part from the lower part. Use a cloth to protect the casing.
3. Replace the battery with a new one.

Recommended battery: CR2025 or equivalent.

- Do not touch the internal circuit and electric terminals as doing so could cause a malfunction.
- Hold the battery by the edges. Holding the battery across the contact points will seriously deplete the storage capacity.
- Make sure that the + side faces the bottom of the case.

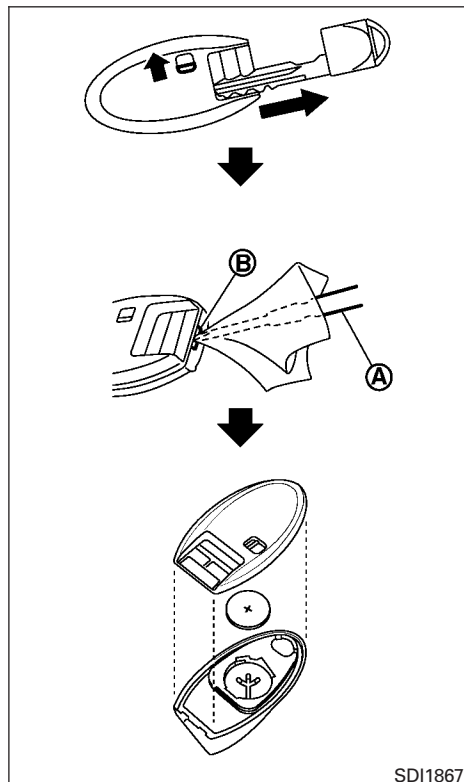

SD11867

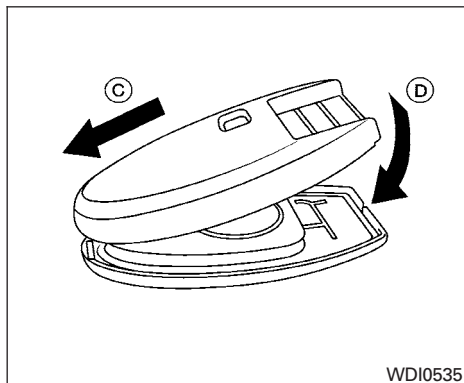

4. Close the lid securely as illustrated (C) (D).
5. Operate the buttons to check the operation.

See a NISSAN dealer if you need assistance for replacement.

#### FCC Notice:

#### For USA:

This device complies with Part 15 of the FCC Rules. Operation is subject to the following two conditions: (1) This device may not cause harmful interference, and (2) this device must accept any interference received, including interference that may cause undesired operation.

**Note:** Changes or modifications not expressly approved by the party responsible for compliance could void the user's authority to operate the equipment.

#### For Canada:

This device complies with Industry Canada licence-exempt RSS standard(s). Operation is subject to the following two conditions: (1) this device may not cause interference, and (2) this device must accept any interference, including interference that may cause undesired operation of the device.

## LIGHTS

### HEADLIGHTS

Replacing the halogen headlight bulb (if so equipped)

The headlight is a semi-sealed beam type which uses a replaceable headlight (halogen) bulb. Because the headlight assembly must be removed from the vehicle for bulb replacement, see your NISSAN dealer.

#### CAUTION

- Aiming is not necessary after replacing the bulb. When aiming adjustment is necessary, contact a NISSAN dealer.
- Do not leave the headlight assembly open without a bulb installed for a long period of time. Dust, moisture, smoke, etc. entering the headlight body may affect bulb performance. Remove the bulb from the headlight assembly just before a replacement bulb is installed.
- Only touch the base when handling the bulb. Never touch the glass envelope. Touching the glass could significantly affect bulb life and/or headlight performance.

- **High pressure halogen gas is sealed inside the halogen bulb. The bulb may break if the glass envelope is scratched or the bulb is dropped.**

Fog may temporarily form inside the lens of the exterior lights in the rain or in a car wash. A temperature difference between the inside and the outside of the lens causes the fog. This is not a malfunction. If large drops of water collect inside the lens, contact a NISSAN dealer.

Replacing the LED headlight bulb (if so equipped)

If LED headlight bulb replacement is required, see your NISSAN dealer.

FOG LIGHTS (if so equipped)

Replacing the fog light bulb

If replacement is required, see your NISSAN dealer.

#### CAUTION

- **High pressure halogen gas is sealed inside the halogen bulb. The bulb may break if the glass envelope is scratched or the bulb is dropped.**
- **When handling the bulb, do not touch the glass envelope.**
- **Use the same number and wattage as originally installed as shown in the chart.**
- **Do not leave the bulb out of the fog light for a long period of time as dust, moisture and smoke may enter the fog light body and affect the performance of the fog light.**

## EXTERIOR AND INTERIOR LIGHTS

Item	Wattage (W)	Bulb No.
Headlight assembly*		
High	60	HB3
Low	55	H11
Park	5	W5W
Turn	21	WY21W
Sidemarker	5	WY5W
Front fog lights (if so equipped)	55	H11
Daytime running lights (Canada only)	19	PS19W
Map light*	—	—
Footwell light	3.4	158
Personal lights	8	P1Y
Glove box light*	8	158
Step light	3.4	194
Courtesy light*	—	—
Vanity mirror light	2	—
Cargo light	—	AL1X
High-mounted stop light*	—	—
Rear combination light		
Tail/Stop*	5/21	7443
Turn	21	WY21W
Rear sidemarker	5	W5W
Backup (reversing)*	12	W16W
License plate light*	5	W5W

\* See a NISSAN dealer for replacement.

Always check with the Parts Department at a NISSAN dealer for the latest parts information.

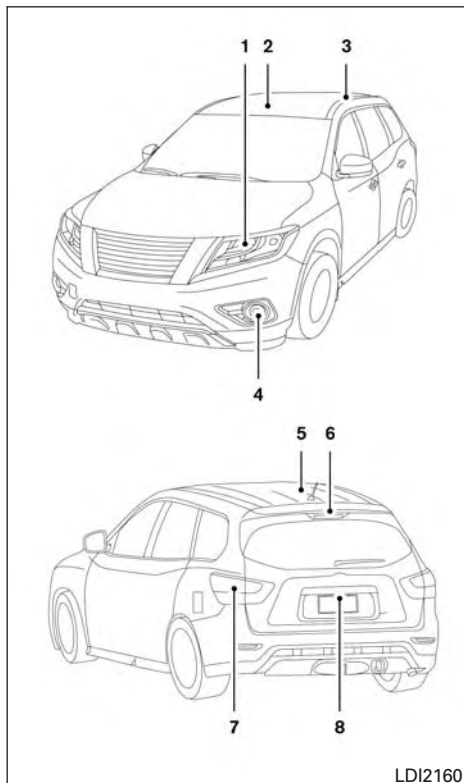

1. Headlight assembly
2. Map light
3. Personal light
4. Fog light (if so equipped)/ Daytime running light (Canada only) (if so equipped)
5. Cargo light
6. Courtesy light
7. Rear combination light
8. License plate light

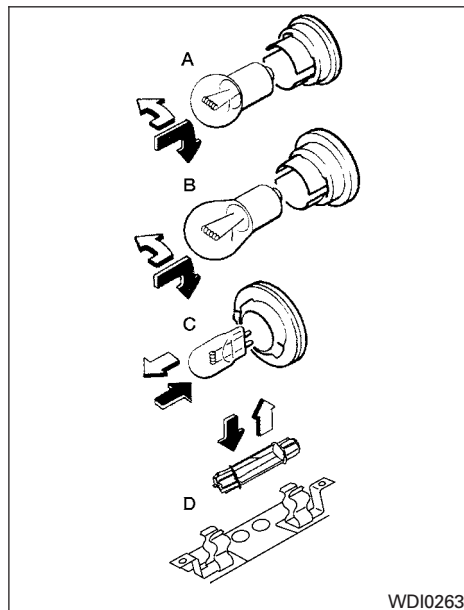

### Replacement procedures

All other lights are either type A, B, C or D. When replacing a bulb, first remove the lens, lamp and/or cover.



Indicates bulb removal



Indicates bulb installation

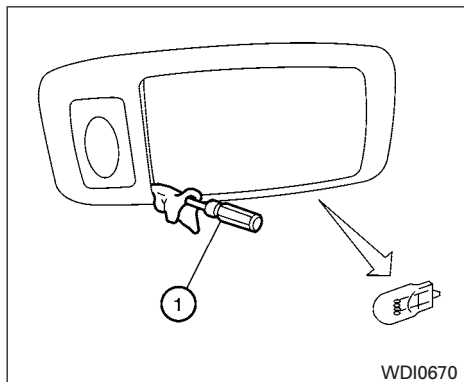

### Personal lights

Use a cloth ① to protect the housing.

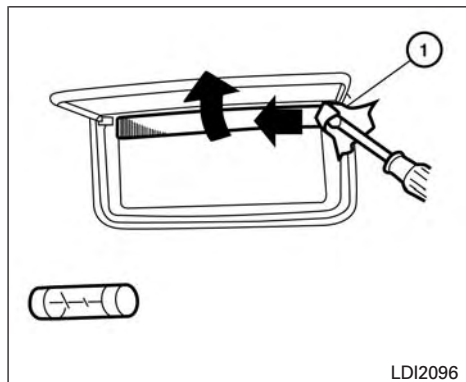

### Vanity mirror

Use a cloth ① to protect the housing.

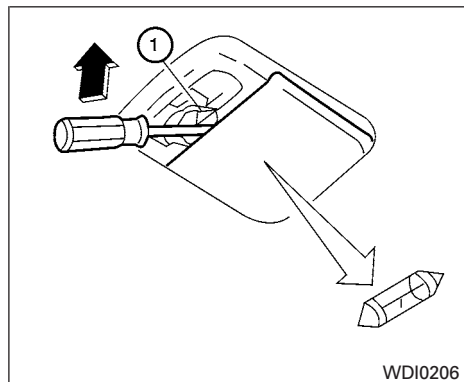

### Cargo light

Use a cloth ① to protect the housing.

## WHEELS AND TIRES

**If you have a flat tire, see “Flat tire” in the “In case of emergency” section of this manual.**

### TIRE PRESSURE

#### Tire Pressure Monitoring System (TPMS)

This vehicle is equipped with the Tire Pressure Monitoring System (TPMS). It monitors tire pressure of all tires except the spare. When the low tire pressure warning light is lit and the Tire Pressure Low - Add Air warning appears in the vehicle information display, one or more of your tires is significantly under-inflated. If equipped, the system also displays pressure of all tires (except the spare tire) on the display screen by sending a signal from a sensor that is installed in each wheel.

The TPMS will activate only when the vehicle is driven at speeds above 16 MPH (25 km/h). Also, this system may not detect a sudden drop in tire pressure (for example a flat tire while driving).

#### 8-32 Maintenance and do-it-yourself

For more details, refer to “Low tire pressure warning light” in the “Instruments and controls” section and “Flat tire” in the “In case of emergency” section.

#### Tire inflation pressure

Check the tire pressures (including the spare) often and always prior to long distance trips. The recommended tire pressure specifications are shown on the F.M.V.S.S./C.M.V.S.S. certification label or the Tire and Loading Information label under the “Cold Tire Pressure” heading. The Tire and Loading Information label is affixed to the driver side center pillar. Tire pressures should be checked regularly because:

- Most tires naturally lose air over time.
- Tires can lose air suddenly when driven over potholes or other objects or if the vehicle strikes a curb while parking.

The tire pressures should be checked when the tires are cold. The tires are considered COLD after the vehicle has been parked for 3 or more hours, or driven less than 1 mile (1.6 km) at moderate speeds.

The TPMS with Easy Fill Tire Alert provides visual and audible signals outside the vehicle for inflating the tires to the recommended COLD tire pressure. For more information, see “TPMS with Easy Fill Tire Alert” in the “Starting and driving” section.

**Incorrect tire pressure, including under inflation, may adversely affect tire life and vehicle handling.**

**⚠ WARNING**

- Improperly inflated tires can fail suddenly and cause an accident.
- The Gross Vehicle Weight Rating (GVWR) is located on the F.M.V.S.S./C.M.V.S.S. certification label. The vehicle weight capacity is indicated on the Tire and Loading Information label. Do not load your vehicle beyond this capacity. Overloading your vehicle may result in reduced tire life, unsafe operating conditions due to premature tire failure, or unfavorable handling characteristics and could also lead to a serious accident. Loading beyond the specified capacity may also result in failure of other vehicle components.
- Before taking a long trip, or whenever you heavily load your vehicle, use a tire pressure gauge to ensure that the tire pressures are at the specified level.

- For additional information regarding tires, refer to “Important Tire Safety Information” (US) or “Tire Safety Information” (Canada) in the Warranty Information Booklet.



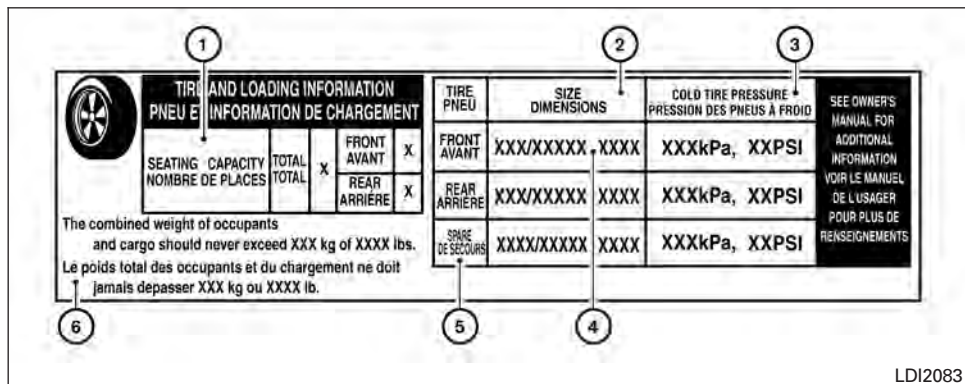

Tire and loading information label

- ① Seating capacity: The maximum number of occupants that can be seated in the vehicle.
- ② Original tire size: The size of the tires originally installed on the vehicle at the factory.

- ③ Cold tire pressure: Inflate the tires to this pressure when the tires are cold. Tires are considered COLD after the vehicle has been parked for 3 or more hours, or driven less than 1 mile (1.6 km) at moderate speeds. The recommended cold tire inflation is set by the manufacturer to provide the best balance of tire wear, vehicle handling, driveability, tire noise, etc., up to the vehicle's GVWR.

- ④ Tire size - refer to "Tire labeling" in this section.
- ⑤ Spare tire size.
- ⑥ Vehicle load limit: See "Vehicle loading information" in the "Technical and consumer information" section.

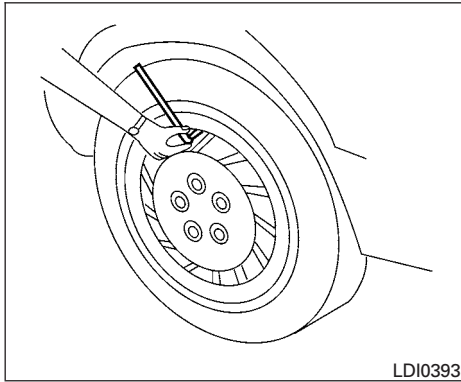

### Checking tire pressure

1. Remove the valve stem cap from the tire.
2. Press the pressure gauge squarely onto the valve stem. Do not press too hard or force the valve stem sideways, or air will escape. If the hissing sound of air escaping from the tire is heard while checking the pressure, reposition the gauge to eliminate this leakage.
3. Remove the gauge.

4. Read the tire pressure on the gauge stem and compare to the specification shown on the Tire and Loading Information label.
5. Add air to the tire as needed. If too much air is added, press the core of the valve stem briefly with the tip of the gauge stem to release pressure. Recheck the pressure and add or release air as needed.
6. Install the valve stem cap.
7. Check the pressure of all other tires, including the spare.

Size	Cold Tire Inflation Pressure
Front and Rear Original Tire: 225/65R17 102H	33 PSI, 230 kPa
Front and Rear Original Tire: 225/65RF17 100H	33 PSI, 230 kPa
Front and Rear Original Tire: 225/60R18 100H	33 PSI, 230 kPa
Spare Tire: T155/90D17 101M	60 PSI, 420 kPa
Spare Tire: T145/90D16 106M	60 PSI, 420 kPa

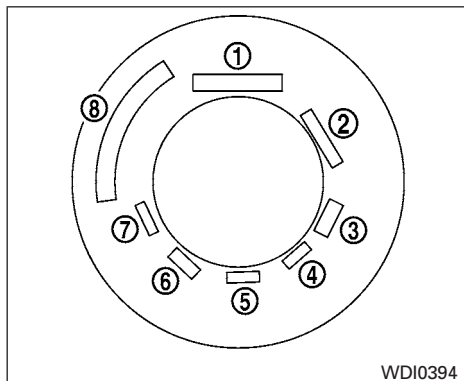

Example

## TIRE LABELING

Federal law requires tire manufacturers to place standardized information on the sidewall of all tires. This information identifies and describes the fundamental characteristics of the tire and also provides the tire identification number (TIN) for safety standard certification. The TIN can be used to identify the tire in case of a recall.

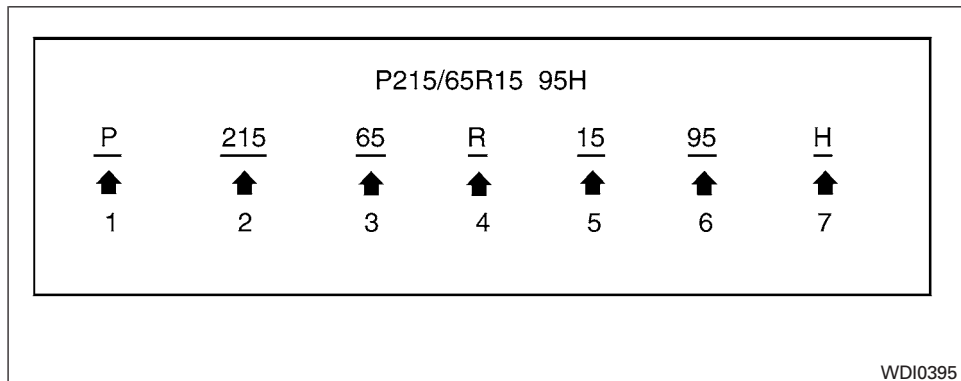

Example

- ① Tire size (example: P215/65R15 95H)
  1. P: The "P" indicates the tire is designed for passenger vehicles (not all tires have this information).
  2. Three-digit number (215): This number gives the width in millimeters of the tire from sidewall edge to sidewall edge.
  3. Two-digit number (65): This number, known as the aspect ratio, gives the tire's ratio of height to width.
  4. R: The "R" stands for radial.
  5. Two-digit number (15): This number is the wheel or rim diameter in inches.
  6. Two- or three-digit number (95): This number is the tire's load index. It is a measurement of how much weight each tire can support. You may not find this information on all tires because it is not required by law.
  7. H: Tire speed rating. You should not drive the vehicle faster than the tire speed rating.

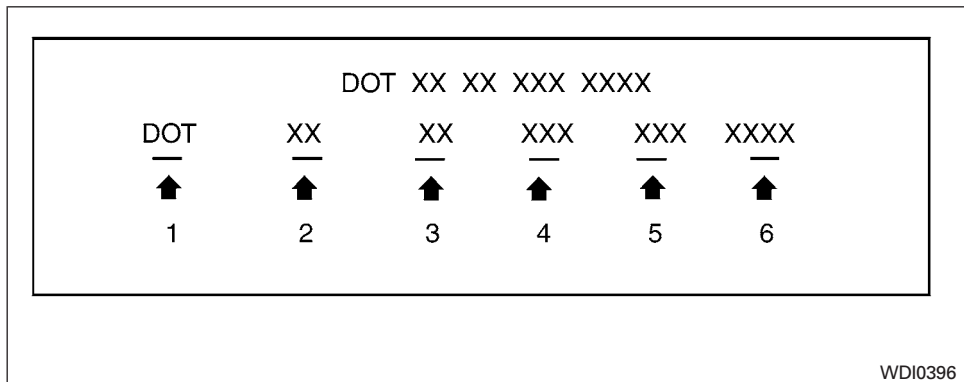

**Example**

② TIN (Tire Identification Number) for a new tire (example: DOT XX XX XXX XXXX)

1. DOT: Abbreviation for the “Department Of Transportation”. The symbol can be placed above, below or to the left or right of the Tire Identification Number.
2. Two-digit code: Manufacturer’s identification mark.
3. Two-digit code: Tire size.

4. Three-digit code: Tire type code (Optional).
5. Three-digit code: Date of Manufacture.
6. Four numbers represent the week and year the tire was built. For example, the numbers 3103 means the 31st week of 2003. If these numbers are missing then look on the other sidewall of the tire.

③ Tire ply composition and material

The number of layers or plies of rubber-coated fabric in the tire. Tire manufacturers also must indicate the materials in the tire, which include steel, nylon, polyester and others.

④ Maximum permissible inflation pressure

This number is the greatest amount of air pressure that should be put in the tire. Do not exceed the maximum permissible inflation pressure.

⑤ Maximum load rating

This number indicates the maximum load in kilograms and pounds that can be carried by the tire. When replacing the tires on the vehicle, always use a tire that has the same load rating as the factory installed tire.

⑥ Term of “tubeless” or “tube type”

Indicates whether the tire requires an inner tube (“tube type”) or not (“tubeless”).

### ⑦ The word “radial”

The word “radial” is shown if the tire has radial structure.

### ⑧ Manufacturer or brand name

Manufacturer or brand name is shown.

### Other Tire-related Terminology

In addition to the many terms that are defined throughout this section, Intended Outboard Sidewall is (1) the sidewall that contains a whitewall, bears white lettering or bears manufacturer, brand, and/or model name molding that is higher or deeper than the same molding on the other sidewall of the tire, or (2) the outward facing sidewall of an asymmetrical tire that has a particular side that must always face outward when mounted on a vehicle.

## TYPES OF TIRES

### WARNING

- When changing or replacing tires, be sure all four tires are of the same type (i.e., Summer, All Season or Snow) and construction. A NISSAN dealer may be able to help you with information about tire type, size, speed rating and availability.
- Replacement tires may have a lower speed rating than the factory equipped tires, and may not match the potential maximum vehicle speed. Never exceed the maximum speed rating of the tire.
- Replacing tires with those not originally specified by NISSAN could affect the proper operation of the low tire pressure warning system.
- For additional information regarding tires, refer to “Important Tire Safety Information” (US) or “Tire Safety Information” (Canada) in the Warranty Information Booklet.

All-Wheel Drive (AWD) models

### CAUTION

**Always use tires of the same type, size, brand, construction (bias, bias-belted or radial), and thread pattern on all four wheels. Failure to do so may result in a circumference difference between tires on the front and rear axles which will cause excessive tire wear and may damage the transmission, transfer case and differential gears.**

**ONLY use spare tires specified for the AWD model.**

If excessive tire wear is found, it is recommended that all four tires be replaced with tires of the same size, brand, construction and tread pattern. The tire pressure and wheel alignment should also be checked and corrected as necessary. Contact a NISSAN dealer.

### All season tires

NISSAN specifies All Season tires on some models to provide good performance all year, including snowy and icy road conditions. All Season tires are identified by ALL SEASON and/or M&S on the tire sidewall. Snow tires have better snow traction than All Season tires and may be more appropriate in some areas.

## Summer tires

NISSAN specifies summer tires on some models to provide superior performance on dry roads. Summer tire performance is substantially reduced in snow and ice. Summer tires do not have the tire traction rating “M&S” on the tire sidewall.

If you plan to operate your vehicle in snowy or icy conditions, NISSAN recommends the use of SNOW tires or ALL SEASON tires on all four wheels.

## Snow tires

If snow tires are needed, it is necessary to select tires equivalent in size and load rating to the original equipment tires. If you do not, it can adversely affect the safety and handling of your vehicle.

Generally, snow tires have lower speed ratings than factory equipped tires and may not match the potential maximum vehicle speed. Never exceed the maximum speed rating of the tire.

If you install snow tires, they must be the same size, brand, construction and tread pattern on all four wheels.

For additional traction on icy roads, studded tires may be used. However, some U.S. states and Canadian provinces prohibit their use. Check local, state and provincial laws before installing

studded tires. Skid and traction capabilities of studded snow tires on wet or dry surfaces may be poorer than that of non-studded snow tires.

## Run-Flat Tires (if so equipped)

Your vehicle is equipped with run-flat tires. You can continue driving to a safe location even if they are punctured. Always use run-flat tires of the specified size on all four wheels. Mixing tire sizes or construction may reduce vehicle handling stability. If necessary, contact your NISSAN dealer for assistance.

Frequently check the tire pressure and adjust pressure of each tire properly. The tire pressure can be also checked in the vehicle information display.

It can be difficult to tell if a run-flat tire is under-inflated or flat. Check the tire pressures as described in this section. If the tire becomes under-inflated while driving, the low tire pressure warning light will illuminate. If the tire becomes flat while driving, the low tire pressure warning light and the “Tire Pressure Low Add Air” warning will appear.

### Low tire pressure:

If the vehicle is being driven with low tire pressure, the low tire pressure warning light will illuminate.

### Flat tire:

If the vehicle is being driven with one or more flat tires, the low tire pressure warning light will illuminate continuously and a chime will sound for 10 seconds. A “Tire Pressure Low Add Air” warning also appears in the vehicle information display.

The chime will only sound at the first indication of a flat tire and the warning light will illuminate continuously. When the flat tire warning is activated, have the system reset and the tire checked and replaced if necessary by your NISSAN dealer. Even if the tire is inflated to the specified COLD tire pressure, the warning light will continue to illuminate until the system is reset by your NISSAN dealer.

If the low tire pressure warning light illuminates continuously and the “Tire Pressure Low Add Air” warning appears in the vehicle information display:

- Do not exceed 50 MPH (80 km/h).
- Increase your following distance to allow for increased stopping distances.
- Avoid sudden maneuvers, hard cornering and hard braking.

### WARNING

- Although you can continue driving with a punctured run-flat tire, remember that vehicle handling stability is reduced, which could lead to an accident and personal injury. Also, driving a long distance at high speeds may damage the tire.
- Do not drive at speeds above 50 MPH (80 km/h) and do not drive more than approximately 93 miles (150 km) with a punctured run-flat tire. The actual distance the vehicle can be driven on a flat tire depends on outside temperature, vehicle load, road conditions and other factors.
- Drive safely at reduced speeds. Avoid hard cornering or braking, which may cause you to lose control of the vehicle.
- If you detect any unusual sounds or vibrations while driving with a punctured run-flat tire, pull off the road to a safe location and stop the vehicle as soon as possible. The tire may be seriously damaged and need to be replaced.

### CAUTION

- Never install tire chains on a punctured run-flat tire, as this could damage your vehicle.
- Avoid driving over any projection or pothole, as the clearance between the vehicle and the ground is smaller than normal.
- Do not enter an automated car wash with a punctured run-flat tire.
- Have the punctured tire inspected by a NISSAN dealer or other authorized repair shop. Replace the tire as soon as possible if the tire is seriously damaged.

## TIRE CHAINS

### CAUTION

**Tire chains/cables should not be installed on 235/55R20 size tires. Installation of the tire chains/cables on 235/55R20 size tires will cause damage to the vehicle. If you plan to use tire chains/cables, you should install 235/65R18 size tires on your vehicle.**

Use of tire chains may be prohibited according to location. Check the local laws before installing

tire chains. When installing tire chains, make sure they are the proper size for the tires on your vehicle and are installed according to the chain manufacturer's suggestions. **Use only SAE class "S" chains.** Class "S" chains are used on vehicles with restricted tire to vehicle clearance. Vehicles that can use Class "S" chains are designed to meet the minimum clearances between the tire and the closest vehicle suspension or body component required to accommodate the use of a winter traction device (tire chains or cables). The minimum clearances are determined using the factory equipped tire size. Other types may damage your vehicle. Use chain tensioners when recommended by the tire chain manufacturer to ensure a tight fit. Loose end links of the tire chain must be secured or removed to prevent the possibility of whipping action damage to the fenders or underbody. If possible, avoid fully loading your vehicle when using tire chains. In addition, drive at a reduced speed. Otherwise, your vehicle may be damaged and/or vehicle handling and performance may be adversely affected.

Do not use tire chains on dry roads. Driving with chains in such conditions can cause damage to the various mechanisms of the vehicle due to some overstress.

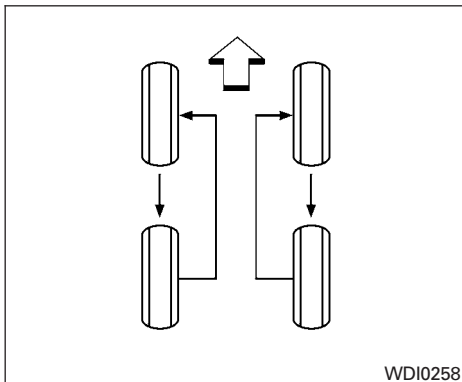

WDI0258

## CHANGING WHEELS AND TIRES

### Tire rotation

NISSAN recommends rotating the tires every 7,500 miles (12,000 km).

See “Flat tire” in the “In case of emergency” section of this manual for tire replacing procedures.

**As soon as possible, tighten the wheel nuts to the specified torque with a torque wrench.**

**Wheel nut tightening torque:  
83 ft-lb (113 N-m)**

**The wheel nuts must be kept tightened to specifications at all times. It is recommended that wheel nuts be tightened to specification at each tire rotation interval.**

### **⚠ WARNING**

- After rotating the tires, check and adjust the tire pressure.
- Retighten the wheel nuts when the vehicle has been driven for 600 miles (1,000 km) (also in cases of a flat tire, etc.).
- Do not include the spare tire in the tire rotation.
- For additional information regarding tires, refer to “Important Tire Safety Information” (US) or “Tire Safety Information” (Canada) in the Warranty Information Booklet.

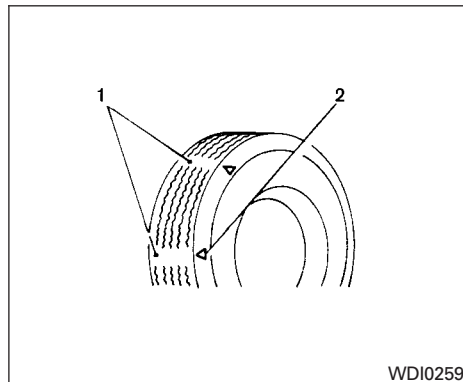

WDI0259

1. Wear indicator
2. Location mark

### Tire wear and damage

### **⚠ WARNING**

- Tires should be periodically inspected for wear, cracking, bulging or objects caught in the tread. If excessive wear, cracks, bulging or deep cuts are found, the tire(s) should be replaced.



- **The original tires have built-in tread wear indicators. When the wear indicators are visible, the tire(s) should be replaced.**
- **Tires degrade with age and use. Have tires, including the spare, over 6 years old checked by a qualified technician because some tire damage may not be obvious. Replace the tires as necessary to prevent tire failure and possible personal injury.**
- **Improper service of the spare tire may result in serious personal injury. If it is necessary to repair the spare tire, contact a NISSAN dealer.**
- **For additional information regarding tires, refer to “Important Tire Safety Information” (US) or “Tire Safety Information” (Canada) in the Warranty Information Booklet.**

## Replacing wheels and tires

When replacing a tire, use the same size, tread design, speed rating and load carrying capacity as originally equipped. Recommended types and sizes are shown in “Wheels and tires” in the “Technical and consumer information” section of this manual.

### **WARNING**

- **The use of tires other than those recommended or the mixed use of tires of different brands, construction (bias, bias-belted or radial), or tread patterns can adversely affect the ride, braking, handling, VDC system, ground clearance, body-to-tire clearance, tire chain clearance, speedometer calibration, headlight aim and bumper height. Some of these effects may lead to accidents and could result in serious personal injury.**

- **For 2WD models, if your vehicle was originally equipped with 4 tires that were the same size and you are only replacing 2 of the 4 tires, install the new tires on the rear axle. Placing new tires on the front axle may cause loss of vehicle control in some driving conditions and cause an accident and personal injury**
- **If the wheels are changed for any reason, always replace with wheels which have the same off-set dimension. Wheels of a different off-set could cause premature tire wear, degrade vehicle handling characteristics, affect the VDC system and/or interference with the brake discs/drums. Such interference can lead to decreased braking efficiency and/or early brake pad/shoe wear. Refer to “Wheels and tires” in the “Technical and consumer information” section of this manual for wheel off-set dimensions.**

- When a spare tire is mounted or a wheel is replaced, tire pressure will not be indicated, the TPMS will not function and the low tire pressure warning light will flash for approximately 1 minute. The light will remain on after 1 minute. Contact your NISSAN dealer as soon as possible for tire replacement and/or system resetting.
- Replacing tires with those not originally specified by NISSAN could affect the proper operation of the TPMS.
- Do not install a damaged or deformed wheel or tire even if it has been repaired. Such wheels or tires could have structural damage and could fail without warning.
- The use of retread tires is not recommended.
- For additional information regarding tires, refer to “Important Tire Safety Information” (US) or “Tire Safety Information” (Canada) in the Warranty Information Booklet.

### CAUTION

Always use tires of the same type, size, brand, constructional (bias, bias-belted or radial), and thread pattern on all four wheels. Failure to do so may result in a circumference difference between tires on the front and rear axles which will cause excessive tire wear and may damage the transmission, transfer case and differential gears (AWD models).

### Wheel balance

Unbalanced wheels may affect vehicle handling and tire life. Even with regular use, wheels can get out of balance. Therefore, they should be balanced as required.

**Wheel balance service should be performed with the wheels off the vehicle. Spin balancing the wheels on the vehicle could lead to mechanical damage.**

- For additional information regarding tires, refer to “Important Tire Safety Information” (US) or “Tire Safety Information” (Canada) in the Warranty Information Booklet.

### Care of wheels

- Wash the wheels when washing the vehicle to maintain their appearance.
- Clean the inner side of the wheels when the wheel is changed or the underside of the vehicle is washed.
- Do not use abrasive cleaners when washing the wheels.
- Inspect wheel rims regularly for dents or corrosion. Such damage may cause loss of pressure or poor seal at the tire bead.
- NISSAN recommends waxing the road wheels to protect against road salt in areas where it is used during winter.

# MEMO

# 9 Technical and consumer information

Recommended fluids/lubricants and capacities . . . . .	9-2	Vehicle loading information . . . . .	9-14
Fuel recommendation . . . . .	9-4	Terms . . . . .	9-14
Engine oil and oil filter recommendations . . . . .	9-6	Vehicle load capacity . . . . .	9-15
Air conditioner system refrigerant and oil recommendations . . . . .	9-7	Securing the load. . . . .	9-17
Specifications . . . . .	9-8	Loading tips . . . . .	9-18
Engine . . . . .	9-8	Measurement of weights . . . . .	9-18
Wheels and tires . . . . .	9-9	Towing a trailer . . . . .	9-18
Dimensions and weights . . . . .	9-9	Maximum load limits . . . . .	9-19
When traveling or registering your vehicle in another country . . . . .	9-10	Towing load/specification. . . . .	9-22
Vehicle identification . . . . .	9-10	Towing safety . . . . .	9-23
Vehicle identification number (VIN) plate . . . . .	9-10	Flat towing for All-Wheel drive vehicle (if so equipped) . . . . .	9-27
Vehicle identification number (chassis number) . . . . .	9-10	Flat towing for front wheel drive vehicle (if so equipped) . . . . .	9-27
Engine serial number. . . . .	9-11	Uniform tire quality grading . . . . .	9-28
F.M.V.S.S./C.M.V.S.S. certification label . . . . .	9-11	Emission control system warranty . . . . .	9-29
Emission control information label . . . . .	9-11	Reporting safety defects . . . . .	9-29
Tire and loading information label. . . . .	9-12	Readiness for inspection/maintenance (I/M) test . . . . .	9-30
Air conditioner specification label. . . . .	9-12	Event Data Recorders (EDR). . . . .	9-31
Installing front license plate . . . . .	9-13	Owner's Manual/Service Manual order information . . . . .	9-32

## RECOMMENDED FLUIDS/ LUBRICANTS AND CAPACITIES

The following are approximate capacities. The actual refill capacities may be a little different. When refilling, follow the procedure described in the “Maintenance and do-it-yourself” section to determine the proper refill capacity.

		Capacity (Approximate)			Recommended Fluids and Lubricants
		US measure	Imp measure	Liter	
Fuel		14-1/2 Gal	12-1/8 Gal	55L	<ul style="list-style-type: none"> <li>• Unleaded gasoline with an octane rating of at least 87 AKI (RON 91)</li> <li>• For further details, see “Fuel recommendation.”</li> </ul>
Engine oil		Drain and refill			
QR25DE	With oil filter change	5-1/8 qt	4-1/4 qt	4.6	<ul style="list-style-type: none"> <li>• Genuine NISSAN engine oil or equivalent</li> <li>• Engine oil with API Certification Mark</li> <li>• Viscosity SAE 0W-20</li> <li>• For further details, see “Engine oil and oil filter recommendations” in this section.</li> </ul>
	Without oil filter change	4-3/4 qt	4 qt	4.3	<ul style="list-style-type: none"> <li>• As an alternative to this recommended oil, SAE 5W-30 conventional petroleum based oil may be used and meet all specifications and requirements necessary to maintain the New Vehicle Limited Warranty.</li> </ul>
Cooling system	With reservoir	1-3/4 gal	1-1/2 gal	6.7	<ul style="list-style-type: none"> <li>• Pre-diluted Genuine NISSAN Long Life Antifreeze/Coolant (blue) or equivalent</li> </ul>
Continuously Variable Transmission (CVT) fluid		—	—	—	<ul style="list-style-type: none"> <li>• Refill to the proper level according to the instructions in the “Do-it-yourself” section.</li> <li>• Genuine NISSAN CVT Fluid NS-3</li> <li>• <b>Use only Genuine NISSAN CVT Fluid NS-3. Using transmission fluid other than Genuine NISSAN CVT Fluid NS-3 will damage the CVT, which is not covered by the NISSAN new vehicle limited warranty.</b></li> </ul>
Differential gear oil		—	—	—	<ul style="list-style-type: none"> <li>• Genuine NISSAN Differential Oil Hypoid Super GL-5, 80W-90 or API GL-5, viscosity SAE 80W-90</li> <li>• For hot climates, Viscosity SAE- 90 is suitable for ambient temperatures above 0° (32 F)</li> </ul>

	Capacity (Approximate)			Recommended Fluids and Lubricants
Transfer oil	—	—	—	•Genuine NISSAN Differential Oil Hypoid Super GL-5 80W-90 or API GL-5, viscosity SAE 80W-90
Brake fluid	—	—	—	•Refill to the proper level according to the instructions in the "Do-it-yourself" section. • Genuine NISSAN Super Heavy Duty Brake Fluid (Available in mainland USA through your authorized NISSAN dealer) or equivalent DOT 3
Multi-purpose grease	—	—	—	• NLGI No. 2 (Lithium Soap base) •See your NISSAN dealer for service.
Air conditioning system refrigerant	—	—	—	• HFC-134a (R-134a) •For further details, see "Air conditioner system refrigerant and oil recommendations." •See your NISSAN dealer for service.
Air conditioning system oil	—	—	—	• NISSAN A/C System Oil Type ND-OIL8 or equivalent •For further details, see "Air conditioner system refrigerant and oil recommendations." •See your NISSAN dealer for service.
Windshield-washer fluid	—	—	—	•Refill to the proper level according to the instructions in the "Do-it-yourself" section. • Genuine NISSAN Windshield Washer Concentrate Cleaner & Antifreeze or equivalent

## FUEL RECOMMENDATION

Use unleaded regular gasoline with an octane rating of at least 87 AKI (Anti-Knock Index) number (Research octane number 91).

### CAUTION

- **Only vehicles with the E-85 filler door label can operate on E-85. Fuel system or other damage can occur if E-85 is used in vehicles that are not designed to run on E-85.**
- **Using a fuel other than that specified could adversely affect the emission control system, and may also affect the warranty coverage.**
- **Under no circumstances should a leaded gasoline be used, because this will damage the three-way catalyst.**
- **Do not use E-15 or E-85 fuel in your vehicle. Your vehicle is not designed to run on E-15 or E-85 fuel. Using E-15 or E-85 fuel in a vehicle not specifically designed for E-15 or E-85 fuel can adversely affect the emission control devices and systems of the vehicle. Damage caused by such fuel is not covered by the NISSAN new vehicle limited warranty.**

- **U.S. government regulations require ethanol dispensing pumps to be identified by a small, square, orange and black label with the common abbreviation or the appropriate percentage for that region.**

### Gasoline specifications

NISSAN recommends using gasoline that meets the World-Wide Fuel Charter (WWFC) specifications where it is available. Many of the automobile manufacturers developed this specification to improve emission control system and vehicle performance. Ask your service station manager if the gasoline meets the WWFC specifications.

### Reformulated gasoline

Some fuel suppliers are now producing reformulated gasolines. These gasolines are specially designed to reduce vehicle emissions. NISSAN supports efforts towards cleaner air and suggests that you use reformulated gasoline when available.

### Gasoline containing oxygenates

Some fuel suppliers sell gasoline containing oxygenates such as ethanol, MTBE and methanol with or without advertising their presence. NISSAN does not recommend the use of fuels of which the oxygenate content and the fuel com-

patibility for your NISSAN cannot be readily determined. If in doubt, ask your service station manager.

If you use oxygenate-blend gasoline, please take the following precautions as the usage of such fuels may cause vehicle performance problems and/or fuel system damage.

- **The fuel should be unleaded and have an octane rating no lower than that recommended for unleaded gasoline.**
- **If an oxygenate-blend other than methanol blend is used, it should contain no more than 10% oxygenate. (MTBE may, however, be added up to 15%.)**
- **E-15 fuel contains more than 10% oxygenate. E-15 fuel will adversely affect the emission control devices and systems of the vehicle and should not be used. Damage caused by such fuel is not covered by the NISSAN new vehicle limited warranty.**

- **If a methanol blend is used, it should contain no more than 5% methanol (methyl alcohol, wood alcohol). It should also contain a suitable amount of appropriate cosolvents and corrosion inhibitors. If not properly formulated with appropriate cosolvents and corrosion inhibitors, such methanol blends may cause fuel system damage and/or vehicle performance problems. At this time, sufficient data is not available to ensure that all methanol blends are suitable for use in NISSAN vehicles.**

If any driveability problems such as engine stalling and difficult hot-starting are experienced after using oxygenate-blend fuels, immediately change to a non-oxygenate fuel or a fuel with a low blend of MTBE.

**Take care not to spill gasoline during refueling. Gasoline containing oxygenates can cause paint damage.**

## E-15 fuel

E-15 fuel is a mixture of approximately 15% fuel ethanol and 85% unleaded gasoline. E-15 can only be used in vehicles designed to run on E-15 fuel. Do not use E-15 in your vehicle. U.S. government regulations require fuel ethanol dispensing pumps to be identified with small, square, orange and black label with the common abbreviation or the appropriate percentage for that region.

## E-85 fuel

E-85 fuel is a mixture of approximately 85% fuel ethanol and 15% unleaded gasoline. E-85 can only be used in a Flexible Fuel Vehicle (FFV). Do not use E-85 in your vehicle. U.S. government regulations require fuel ethanol dispensing pumps to be identified by a small, square, orange and black label with the common abbreviation or the appropriate percentage for that region.

## Aftermarket fuel additives

NISSAN does not recommend the use of any aftermarket fuel additives (for example, fuel injector cleaner, octane booster, intake valve deposit removers, etc.) which are sold commercially. Many of these additives intended for gum, varnish or deposit removal may contain active solvents or similar ingredients that can be harmful to the fuel system and engine.

## Octane rating tips

**Using unleaded gasoline with an octane rating lower than recommended can cause persistent, heavy “spark knock.” (“Spark knock” is a metallic rapping noise.) If severe, this can lead to engine damage. If you detect a persistent heavy spark knock even when using gasoline of the stated octane rating, or if you hear steady spark knock while holding a steady speed on level roads, have a NISSAN dealer correct the condition. Failure to correct the condition is misuse of the vehicle, for which NISSAN is not responsible.**

Incorrect ignition timing may result in spark knock, after-run and/or overheating, which may cause excessive fuel consumption or engine damage. If any of the above symptoms are encountered, have your vehicle checked at a NISSAN dealer.

**However, now and then you may notice light spark knock for a short time while accelerating or driving up hills. This is not a cause for concern, because you get the greatest fuel benefit when there is light spark knock for a short time under heavy engine load.**



API certification mark



API service symbol



LTI2051

## ENGINE OIL AND OIL FILTER RECOMMENDATIONS

### Selecting the correct oil

It is essential to choose the correct grade, quality and viscosity engine oil to ensure satisfactory engine life and performance. See "Recommended fluids/lubricants and capacities" in this section. NISSAN recommends the use of an energy conserving oil in order to improve fuel economy.

Select only engine oils that meet the American Petroleum Institute (API) certification or International Lubricant Standardization and Approval

Committee (ILSAC) certification and SAE viscosity standard. These oils have the API certification mark on the front of the container. Oils which do not have the specified quality label should not be used as they could cause engine damage.

### Oil additives

NISSAN does not recommend the use of oil additives. The use of an oil additive is not necessary when the proper oil type is used and maintenance intervals are followed.

Oil which may contain foreign matter or has been previously used should not be used.

## Oil viscosity

The engine oil viscosity or thickness changes with temperature. Because of this, it is important to select the engine oil viscosity based on the temperatures at which the vehicle will be operated before the next oil change. Choosing an oil viscosity other than that recommended could cause serious engine damage.

### Selecting the correct oil filter

Your new NISSAN vehicle is equipped with a high-quality genuine NISSAN oil filter. When replacing, use a genuine NISSAN oil filter or its equivalent for the reason described in "Change intervals."

### Change intervals

The oil and oil filter change intervals for your engine are based on the use of the specified quality oils and filters. Using engine oil and filters that are not of the specified quality, or exceeding recommended oil and filter change intervals could reduce engine life. Damage to the engine caused by improper maintenance or use of incorrect oil and filter quality and/or viscosity is not covered by the NISSAN new vehicle limited warranty.

Your engine was filled with a high-quality engine oil when it was built. You do not have to change the oil before the first recommended change interval. Oil and filter change intervals depend upon how you use your vehicle.

Operation under the following conditions may require more frequent oil and filter changes:

- repeated short distance driving at cold outside temperatures
- driving in dusty conditions
- extensive idling
- towing a trailer
- stop and go commuting

Refer to the “NISSAN Service and Maintenance Guide” for the maintenance schedule.

## AIR CONDITIONER SYSTEM REFRIGERANT AND OIL RECOMMENDATIONS

**The air conditioner system in your NISSAN vehicle must be charged with the refrigerant HFC-134a (R-134a) and NISSAN A/C system oil Type ND-OIL8 or the exact equivalents.**

### CAUTION

**The use of any other refrigerant or oil will cause severe damage to the air conditioning system and will require the replacement of all air conditioner system components.**

The refrigerant HFC-134a (R-134a) in your NISSAN vehicle does not harm the earth's ozone layer. Although this refrigerant does not affect the earth's atmosphere, certain government regulations require the recovery and recycling of any refrigerant during automotive air conditioner system service. A NISSAN dealer has the trained technicians and equipment needed to recover and recycle your air conditioner system refrigerant.

Contact a NISSAN dealer when servicing your air conditioner system.

## SPECIFICATIONS

### ENGINE

Model	QR25DE
Type	Gasoline, 4-cycle, DOHC
Cylinder arrangement	4-cylinder
Bore x Stroke	in (mm) 3.5 x 3.9 (89.0 x 100.0)
Displacement	cu in (cm <sup>3</sup> ) 151.82 (2,488)
Firing order	1-3-4-2
Idle speed	
CVT (in "N" position)	No adjustment is necessary.
Ignition timing (degree B.T.D.C. at idle speed)	
CO % at idle	
Spark plug	FXE20HE-11C
Spark plug gap (Nominal)	in (mm) 0.043 (1.1)
Camshaft operation	Timing chain

**This spark ignition system complies with the Canadian standard ICES-002.**

## WHEELS AND TIRES

Wheel type	Size
Steel	17 x 7J
Aluminum	17 x 7J
	18 x 7J
Tire size	
Non Run Flat	225/65RF17
	225/60R18
Run Flat	225/65R17
Spare tire	
Spare Wheel - Steel	T155/90D17
Spare Wheel - Steel	T145/90D16
Spare Wheel - Aluminum	T145/90D16

## DIMENSIONS AND WEIGHTS

Overall length (without front license plate bracket)	in (mm)	182.8 (4,643)
Overall length (with front license plate bracket)	in (mm)	183.3 (4,655)
Overall width	in (mm)	72 (1,830)
Overall height		
without roof rack	in (mm)	66.8 (1,696)
with roof rack	in (mm)	67.5 (1,714)
Front and Rear Track	in (mm)	62.8 (1,595)
Wheelbase	in (mm)	106.5 (2,706)
Gross vehicle weight rating	lb (kg)	See the "F.M.V.S.S./C.M.V. S.S. certification label" on the center pillar between the driver's side front and rear doors.
Gross axle weight rating		
Front	lb (kg)	
Rear	lb (kg)	

## WHEN TRAVELING OR REGISTERING YOUR VEHICLE IN ANOTHER COUNTRY

When planning to drive your NISSAN vehicle in another country, you should first find out if the fuel available is suitable for your vehicle's engine.

Using fuel with an octane rating that is too low may cause engine damage. All gasoline vehicles must be operated with unleaded gasoline. Therefore, avoid taking your vehicle to areas where appropriate fuel is not available.

When transferring the registration of your vehicle to another country, state, province or district, it may be necessary to modify the vehicle to meet local laws and regulations.

The laws and regulations for motor vehicle emission control and safety standards vary according to the country, state, province or district; therefore, vehicle specifications may differ.

When any vehicle is to be taken into another country, state, province or district and registered, its modifications, transportation and registration are the responsibility of the user. NISSAN is not responsible for any inconvenience that may result.

## VEHICLE IDENTIFICATION

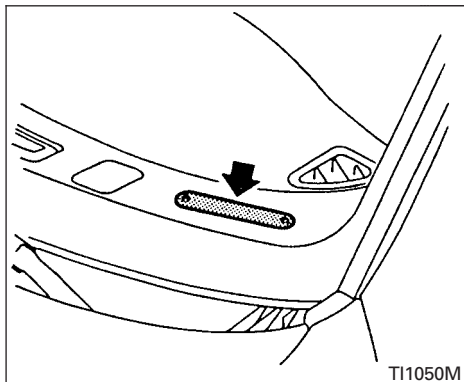

### VEHICLE IDENTIFICATION NUMBER (VIN) PLATE

The vehicle identification number (VIN) plate is located as shown. This number is the identification for your vehicle and is used in the vehicle registration.

The vehicle identification number (VIN) number is also available through the center display screen. See your "Navigation System Owner's Manual" for further information.

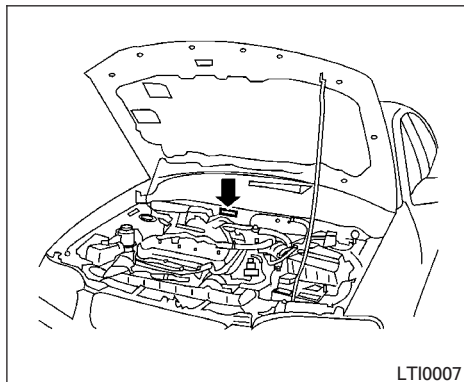

### VEHICLE IDENTIFICATION NUMBER (chassis number)

The vehicle identification number is located as shown.

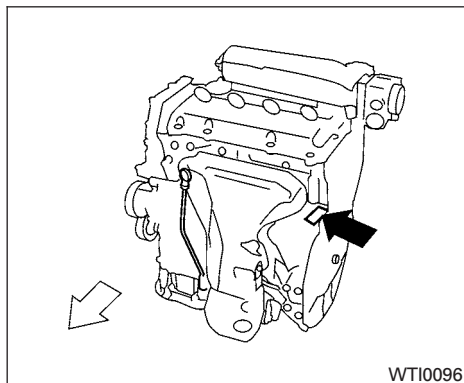

### ENGINE SERIAL NUMBER

The number is stamped on the engine as shown.

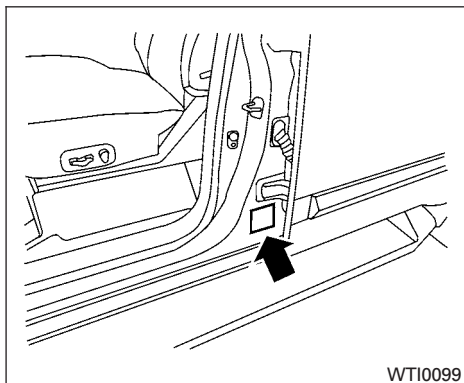

### F.M.V.S.S./C.M.V.S.S. CERTIFICATION LABEL

The Federal/Canadian Motor Vehicle Safety Standard (F.M.V.S.S./C.M.V.S.S.) certification label is affixed as shown. This label contains valuable vehicle information, such as: Gross Vehicle Weight Ratings (GVWR), Gross Axle Weight Rating (GAWR), month and year of manufacture, Vehicle Identification Number (VIN), etc. Review it carefully.

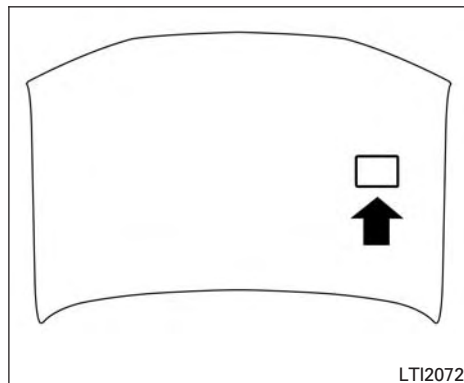

### EMISSION CONTROL INFORMATION LABEL

The emission control information label is attached to the underside of the hood as shown.

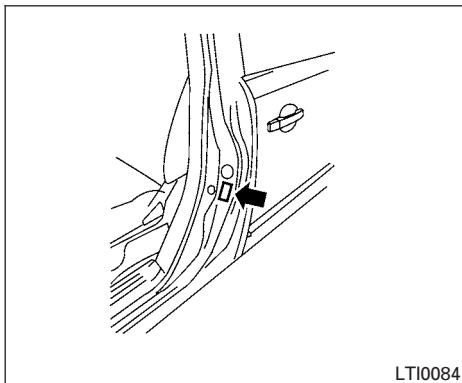

### TIRE AND LOADING INFORMATION LABEL

The cold tire pressure is shown on the Tire and Loading Information label. The label is located as shown.

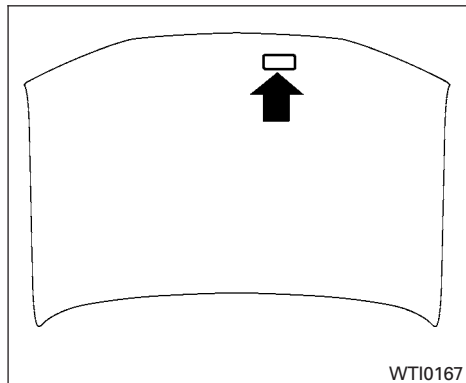

### AIR CONDITIONER SPECIFICATION LABEL

The air conditioner specification label is affixed to the underside of the hood as shown.

## INSTALLING FRONT LICENSE PLATE

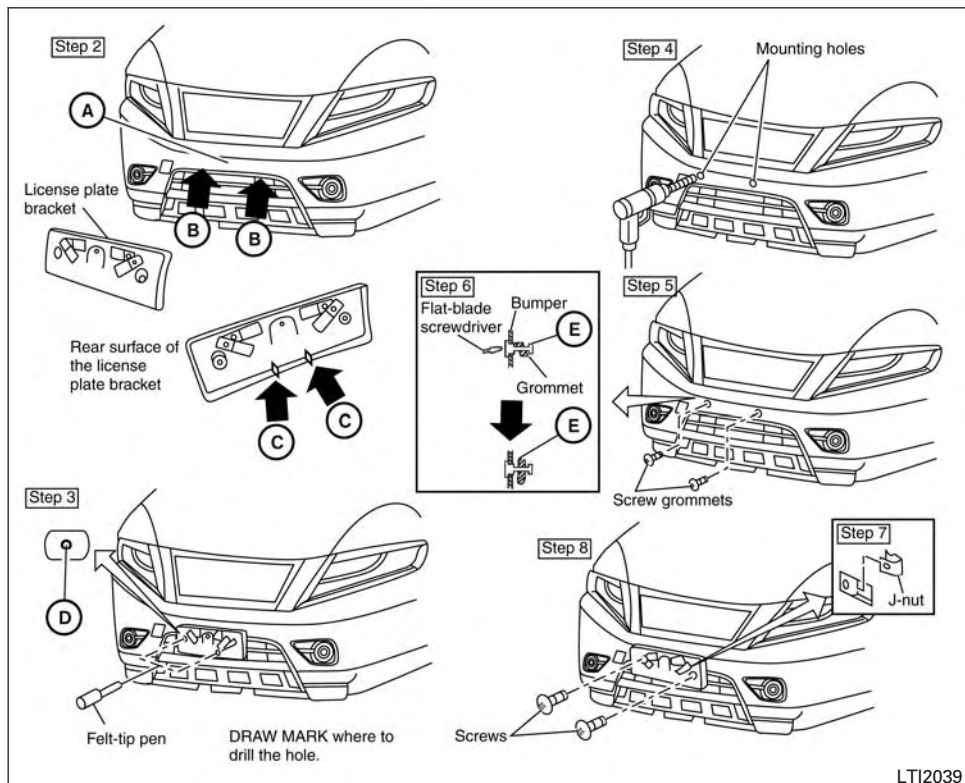

Use the following steps to mount the front license plate:

Before mounting the license plate, confirm that the following parts are enclosed in the plastic bag:

- License plate bracket
- License plate bracket (J-nut) screws x 2
- License plate screws x 2
- Screw grommets x 2

1. Park the vehicle on flat, level ground.
2. Locate the center position (A) as illustrated. Line up the license plate bracket under the top of the front bumper (B) with the tabs (C). Hold the license plate bracket in place.
3. Mark the center of the hole (D) with a felt-tip pen.
4. Carefully drill two pilot holes using a 0.39 in (10 mm) drill bit at the marked locations. **(Be sure that the drill only goes through the bumper fascia.)**
5. Insert the grommets into the holes in the bumper fascia.
6. Insert a small flat-bladed screwdriver into the grommet hole to turn the threaded part of the grommet 90° (E).



## VEHICLE LOADING INFORMATION

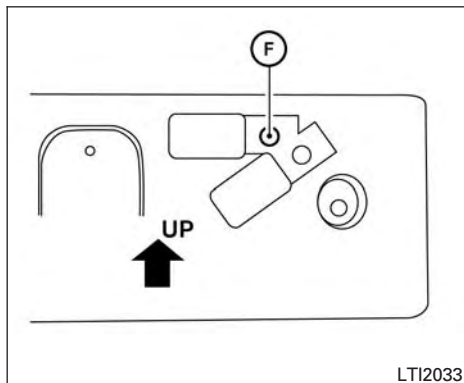

Mark the center of the hole (F) on both sides with a felt-tip pen. Remove the bracket from the bumper, and then open 0.79 in (20 mm) diameter holes on the bumper using the marks (F) as a center.

7. Insert a J-nut into the license plate bracket before placing the license plate bracket on the fascia.
8. Install the license plate bracket with screws.
9. Install the license plate with bolts that are no longer than 0.55 in (14 mm).

### ⚠ WARNING

- **It is extremely dangerous to ride in a cargo area inside a vehicle. In a collision, people riding in these areas are more likely to be seriously injured or killed.**
- **Do not allow people to ride in any area of your vehicle that is not equipped with seats and seat belts.**
- **Be sure everyone in your vehicle is in a seat and using a seat belt properly.**

### TERMS

It is important to familiarize yourself with the following terms before loading your vehicle:

- **Curb Weight** (actual weight of your vehicle) - vehicle weight including: standard and optional equipment, fluids, emergency tools, and spare tire assembly. This weight **does not** include passengers and cargo.

- **GVW (Gross Vehicle Weight)** - curb weight plus the combined weight of passengers and cargo.
- **GVWR (Gross Vehicle Weight Rating)** - maximum total combined weight of the unloaded vehicle, passengers, luggage, hitch, trailer tongue load and any other optional equipment. This information is located on the F.M.V.S.S./C.M.V.S.S. certification label.
- **GAWR (Gross Axle Weight Rating)** - maximum weight (load) limit specified for the front or rear axle. This information is located on the F.M.V.S.S./C.M.V.S.S. certification label.
- **GCWR (Gross Combined Weight rating)** - The maximum total weight rating of the vehicle, passengers, cargo, and trailer.

- Vehicle Capacity Weight, Load limit, Total load capacity - maximum total weight limit specified of the load (passengers and cargo) for the vehicle. This is the maximum combined weight of occupants and cargo that can be loaded into the vehicle. If the vehicle is used to tow a trailer, the trailer tongue weight must be included as part of the cargo load. This information is located on the Tire and Loading Information label.
- Cargo capacity - permissible weight of cargo, the subtracted weight of occupants from the load limit.

## VEHICLE LOAD CAPACITY

Do not exceed the load limit of your vehicle shown as “The combined weight of occupants and cargo” on the Tire and Loading Information label. Do not exceed the number of occupants shown as “Seating Capacity” on the Tire and Loading Information label.

To get “the combined weight of occupants and cargo”, add the weight of all occupants, then add the total luggage weight. Examples are shown in the following illustration.

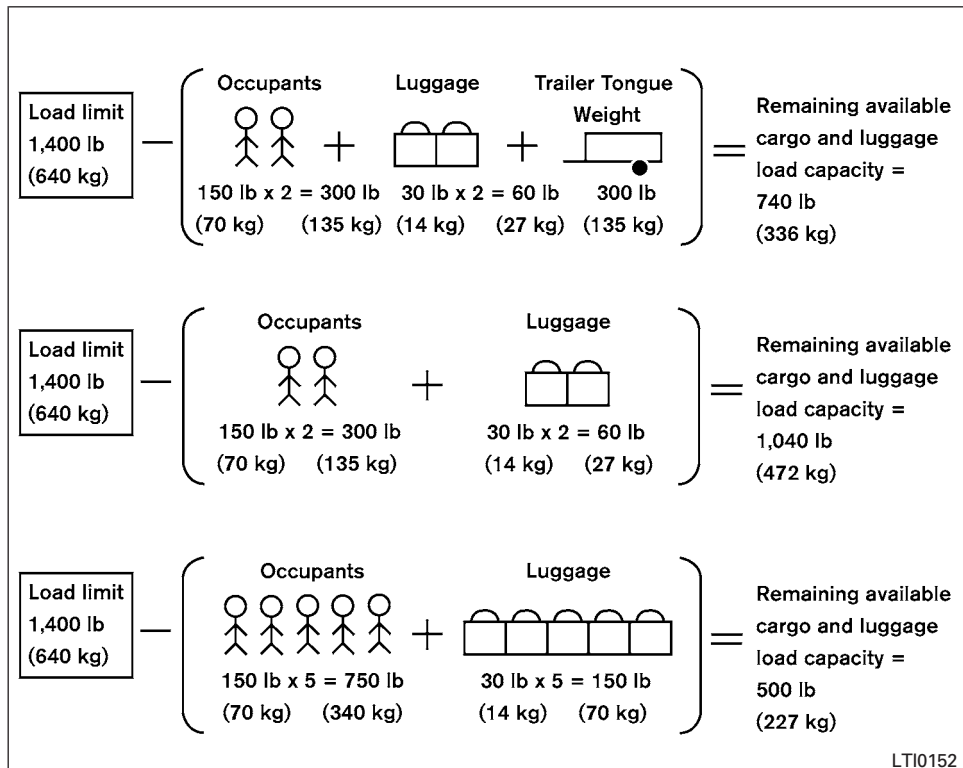

Example

### Steps for determining correct load limit

1. Locate the statement "The combined weight of occupants and cargo should never exceed XXX lbs or XXX kg" on your vehicle's placard.
2. Determine the combined weight of the driver and passengers that will be riding in your vehicle.
3. Subtract the combined weight of the driver and passengers from XXX lbs or XXX kg.
4. The resulting figure equals the available amount of cargo and luggage load capacity. For example, if the XXX amount equals 1,400 lbs. and there will be five 150 lb. passengers in your vehicle, the amount of available cargo and luggage load capacity is 650 lbs. (1,400-750 (5 X 150) = 650 lbs) or (640-340 (5 X 70) = 300 kg.)

- Determine the combined weight of luggage and cargo being loaded on the vehicle. That weight may not safely exceed the available cargo and luggage load capacity calculated in Step 4.
- If your vehicle will be towing a trailer, load from your trailer will be transferred to your vehicle. Consult this manual to determine how this reduces the available cargo and luggage load capacity of your vehicle.

Before driving a loaded vehicle, confirm that you do not exceed the Gross Vehicle Weight Rating (GVWR) or the Gross Axle Weight Rating (GAWR) for your vehicle. See “Measurement of weights” in this section.

Also check tires for proper inflation pressures. See the Tire and Loading Information label.

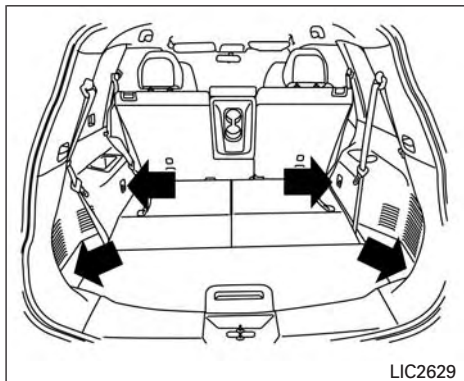

**Cargo area luggage hooks**

## SECURING THE LOAD

There are luggage hooks located in the cargo area as shown. The hooks can be used to secure cargo with ropes or other types of straps.

**Do not apply a total load of more than 6.5 lbs. (29 N) to a single metal floor hook when securing cargo.**

## **WARNING**

- Properly secure all cargo with ropes or straps to help prevent it from sliding or shifting. Do not place cargo higher than the seatbacks. In a sudden stop or collision, unsecured cargo could cause personal injury.
- The child restraint top tether strap may be damaged by contact with items in the cargo area. Secure any items in the cargo area. Your child could be seriously injured or killed in a collision if the top tether strap is damaged.
- Do not load your vehicle any heavier than the GVWR or the maximum front and rear GAWRs. If you do, parts of your vehicle can break, tire damage could occur, or it can change the way your vehicle handles. This could result in loss of control and cause personal injury.

## LOADING TIPS

- The GVW must not exceed GVWR or GAWR as specified on the F.M.V.S.S./C.M.V.S.S. certification label.
- Do not load the front and rear axle to the GAWR. Doing so will exceed the GVWR.

### WARNING

- **Properly secure all cargo with ropes or straps to help prevent it from sliding or shifting. Do not place cargo higher than the seat-backs. In a sudden stop or collision, unsecured cargo could cause personal injury.**
- **Do not load your vehicle any heavier than the GVWR or the maximum front and rear GAWRs. If you do, parts of your vehicle can break, tire damage could occur, or it can change the way your vehicle handles. This could result in loss of control and cause personal injury.**

- **Overloading not only can shorten the life of your vehicle and the tire, but can also cause unsafe vehicle handling and longer braking distances. This may cause a premature tire failure which could result in a serious accident and personal injury. Failures caused by overloading are not covered by the vehicle's warranty.**

## MEASUREMENT OF WEIGHTS

Secure loose items to prevent weight shifts that could affect the balance of your vehicle. When the vehicle is loaded, drive to a scale and weigh the front and the rear wheels separately to determine axle loads. Individual axle loads should not exceed either of the gross axle weight ratings (GAWR). The total of the axle loads should not exceed the gross vehicle weight rating (GVWR). These ratings are given on the vehicle certification label. If weight ratings are exceeded, move or remove items to bring all weights below the ratings.

## TOWING A TRAILER

### WARNING

Overloading or improper loading of a trailer and its cargo can adversely affect vehicle handling, braking and performance and may lead to accidents.

### CAUTION

- **Do not tow a trailer or haul a heavy load for the first 500 miles (800 km). Your engine, axle or other parts could be damaged.**
- **For the first 500 miles (800 km) that you tow a trailer, do not drive over 50 mph (80 km/h) and do not make starts at full throttle. This helps the engine and other parts of your vehicle wear in at the heavier loads.**

Your new vehicle was designed to be used primarily to carry passengers and cargo. Remember that towing a trailer places additional loads on your vehicle's engine, drive train, steering, braking and other systems.

A NISSAN Towing Guide (U.S. only) is available on the website at [www.nissanusa.com](http://www.nissanusa.com). This guide includes information on trailer towing capability and the special equipment required for proper towing.

## MAXIMUM LOAD LIMITS

### Maximum trailer loads

Never allow the total trailer load to exceed the value specified in the “Towing Load/Specification” chart found in this section. The total trailer load equals trailer weight plus its cargo weight.

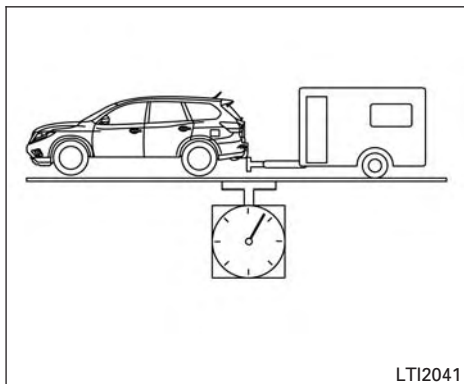

The Gross Combined Weight Rating (GCWR) equals the combined weight of the towing vehicle (including passengers and cargo) plus the total trailer load. Towing loads greater than these or using improper towing equipment could adversely affect vehicle handling, braking and performance.

The ability of your vehicle to tow a trailer is not only related to the maximum trailer loads, but also the places you plan to tow. Tow weights appropriate for level highway driving may have to be reduced for low traction situations (for example, on slippery boat ramps).

Temperature conditions can also affect towing. For example, towing a heavy trailer in high outside temperatures on graded roads can affect engine performance and cause overheating. The engine protection mode, which helps reduce the chance of engine damage, could activate and automatically decrease engine power. Vehicle speed may decrease under high load. Plan your trip carefully to account for trailer and vehicle load, weather and road conditions.

#### **⚠ WARNING**

**Overheating can result in reduced engine power and vehicle speed. The reduced speed may be lower than other traffic, which could increase the chance of a collision. Be especially careful when driving. If the vehicle cannot maintain a safe driving speed, pull to the side of the road in a safe area. Allow the engine to cool and return to normal operation. See “If your vehicle overheats” in the “In case of emergency” section of this manual.**

#### **⚠ CAUTION**

**Vehicle damage resulting from improper towing procedures is not covered by NISSAN warranties.**

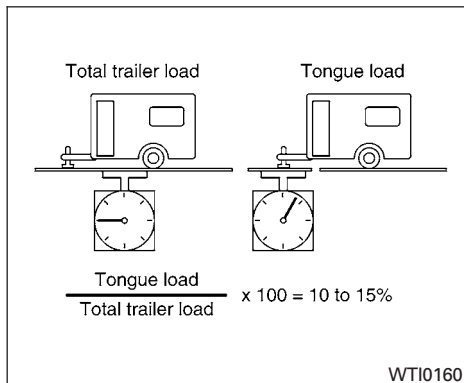

## Tongue load

When using a weight carrying or a weight distributing hitch, keep the tongue load between 10 - 15 percent of the total trailer load or use the trailer tongue load specified by the trailer manufacturer. The tongue load must be within the maximum tongue load limits shown in the following "Towing Load/Specification" chart. If the tongue load becomes excessive, rearrange cargo to allow for proper tongue load.

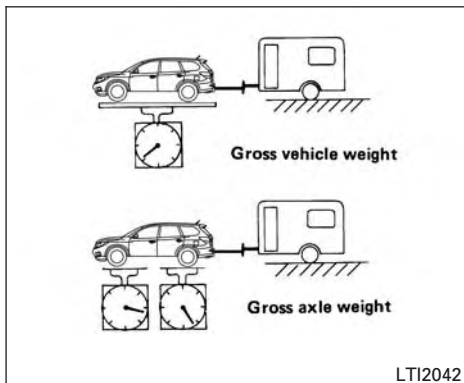

## Maximum Gross Vehicle Weight (GVW)/maximum Gross Axle Weight (GAW)

The GVW of the towing vehicle must not exceed the Gross Vehicle Weight Rating (GVWR) shown on the F.M.V.S.S./C.M.V.S.S. certification label. The GVW equals the combined weight of the unloaded vehicle, passengers, luggage, hitch, trailer tongue load and any other optional equipment. In addition, front or rear GAW must not exceed the Gross Axle Weight Rating (GAWR) shown on the F.M.V.S.S./C.M.V.S.S. certification label.

Towing capacities are calculated assuming a base vehicle with driver and any options required to achieve the rating. Additional passengers, cargo and/or optional equipment, such as the trailer hitch, will add weight to the vehicle and reduce your vehicle's maximum towing capacity and trailer tongue load.

The vehicle and trailer need to be weighed to confirm the vehicle is within the GVWR, Front GAWR, Rear GAWR, Gross Combined Weight Rating (GCWR) and Towing capacity.

All vehicle and trailer weights can be measured using platform type scales commonly found at truck stops, highway weigh stations, building supply centers or salvage yards.

To determine the available payload capacity for tongue/king pin load, use the following procedure.

1. Locate the GVWR on the F.M.V.S.S./C.M.V.S.S. certification label.
2. Weigh your vehicle on the scale with all of the passengers and cargo that are normally in the vehicle when towing a trailer.
3. Subtract the actual vehicle weight from the GVWR. The remaining amount is the available maximum tongue/king pin load.

To determine the available towing capacity, use the following procedure.

1. Find the GCWR for your vehicle on the "Towing Load/Specification" chart found in this section.
2. Subtract the actual vehicle weight from the GCWR. The remaining amount is the available maximum towing capacity.

To determine the Gross Trailer Weight, weigh your trailer on a scale with all equipment and cargo, that are normally in the trailer when it is towed. Make sure the Gross trailer weight is not more than the Gross Trailer Weight Rating shown on the trailer and is not more than the calculated available maximum towing capacity.

Also weigh the front and rear axles on the scale to make sure the Front Gross Axle Weight and Rear Gross Axle Weight are not more than Front Gross Axle Weight and Rear Gross Axle Weight on the F.M.V.S.S./C.M.V.S.S. certification label. The cargo in the trailer and vehicle may need to be moved or removed to meet the specified ratings.

Example:

- Gross Vehicle Weight (GVW) as weighed on a scale - including passengers, cargo and hitch - 6,350 lb. (2,880 kg).

- Gross Vehicle Weight Rating (GVWR) from F.M.V.S.S./C.M.V.S.S. certification label - 7,250 lb. (3,289 kg).
- Gross Combined Weight Rating (GCWR) from "Towing Load/Specification" chart - 15,100 lb. (6,849 kg).
- Maximum Trailer towing capacity from "Towing Load/Specification" chart - 9,100 lb. (4,128 kg).

7,250 lb. (3,289 kg)	GVWR
- 6,350 lb. (2,880 kg)	GVW
= 900 lb. (409 kg)	Available for tongue weight
15,100 lb. (6,849 kg)	GCWR
- 6,350 lb. (2,880 kg)	GVW
= 9,123 lb. (4,138 kg)	Capacity available for towing
900 lb. (409 kg)	Available tongue weight
/ 8,750 lb. (3,969 kg)	Available capacity
=	10 % tongue weight

The available towing capacity may be less than the maximum towing capacity due to the passenger and cargo load in the vehicle.

Remember to keep trailer tongue weight between 10 - 15% of the trailer weight or within the trailer tongue load specification recommended by the trailer manufacturer. If the tongue load becomes excessive, rearrange the cargo to obtain the proper tongue load. Do not exceed the maximum tongue weight specification shown in the "Towing load/specification" chart even if the calculated available tongue weight is greater than 15%. If the calculated tongue weight is less than 10% , reduce the total trailer weight to match the available tongue weight.

Always verify that available capacities are within the required ratings.



## TOWING LOAD/SPECIFICATION

TOWING LOAD/SPECIFICATION CHART	
	U.S. and Canada
Maximum Towing Capacity*1	1,100lb. (500 kg)
Maximum Tongue Load	110 lb. (50 kg)
Maximum Gross Combined Weight Rating	5,291 lb. (2,400 kg)

\*1: The towing capacity values are calculated assuming a base vehicle with driver and any options required to achieve the rating. Additional passengers, cargo and/or optional equipment will add weight to the vehicle and reduce your vehicle's maximum towing capacity.

## Hitch ball

Choose a hitch ball of the proper size and weight rating for your trailer:

- The required hitch ball size is stamped on most trailer couplers. Most hitch balls also have the size printed on the top of the ball.
- Choose the proper class hitch ball based on the trailer weight.
- The diameter of the threaded shank of the hitch ball must be matched to the ball mount hole diameter. The hitch ball shank should be no more than 1/16" smaller than the hole in the ball mount.
- The threaded shank of the hitch ball must be long enough to be properly secured to the ball mount. There should be at least 2 threads showing beyond the lock washer and nut.

## Safety chains

Always use suitable safety chains between your vehicle and the trailer. The safety chains should be crossed and should be attached to the hitch, not to the vehicle bumper or axle. The safety chains can be attached to the bumper if the hitch ball is mounted to the bumper. Be sure to leave enough slack in the chains to permit turning corners.

## TOWING SAFETY

### Trailer hitch

Your vehicle may be equipped with an optional trailer tow package. The trailer tow package includes a receiver-type frame mounted hitch. This hitch is rated for the maximum towing capacity of this vehicle when the proper towing equipment is used. Choose a proper ball mount and hitch ball that is rated for the trailer to be towed. Genuine NISSAN ball mounts and hitch balls are available from your NISSAN dealer.

If your vehicle is not equipped with the optional trailer tow package, check the towing capacity of your bumper hitch or receiver-type frame mounted hitch. Choose a proper hitch for your vehicle and trailer. A genuine NISSAN trailer hitch is available from your NISSAN dealer. Make sure the trailer hitch is securely attached to the vehicle to help avoid personal injury or property damage due to sway caused by crosswinds, rough road surfaces or passing trucks.

### WARNING

**Trailer hitch components have specific weight ratings. Your vehicle may be capable of towing a trailer heavier than the weight rating of the hitch components. Never exceed the weight rating of the hitch components. Doing so can cause serious personal injury or property damage.**

### Hitch ball

Choose a hitch ball of the proper size and weight rating for your trailer:

- The required hitch ball size is stamped on most trailer couplers. Most hitch balls also have the size printed on the top of the ball.
- Choose the proper class hitch ball based on the trailer weight.
- The diameter of the threaded shank of the hitch ball must be matched to the ball mount hole diameter. The hitch ball shank should be no more than 1/16" smaller than the hole in the ball mount.

- The threaded shank of the hitch ball must be long enough to be properly secured to the ball mount. There should be at least 2 threads showing beyond the lock washer and nut.

### Ball mount

The hitch ball is attached to the ball mount and the ball mount is inserted into the hitch receiver. Choose a proper class ball mount based on the trailer weight. Additionally, the ball mount should be chosen to keep the trailer tongue level with the ground.

### Weight carrying hitches

A weight carrying or "dead weight" ball mount is one that is designed to carry the whole amount of tongue weight and gross weight directly on the ball mount and on the receiver.

### Weight distribution hitch

This type of hitch is also called a "load-leveling" or "equalizing" hitch. A set of bars attach to the ball mount and to the trailer to distribute the tongue weight (hitch weight) of your trailer. Many vehicles can't carry the full tongue weight of a given trailer, and need some of the tongue weight transferred through the frame and pushing down on the front wheels. This gives stability to the tow vehicle.

A weight-distributing hitch system (Class IV) is recommended if you plan to tow trailers with a maximum weight over 5,000 lbs (2,268 kg) . Check with the trailer and towing equipment manufacturers to determine if they recommend the use of a weight-distributing hitch system.

#### **NOTE:**

**A weight-distributing hitch system may affect the operation of trailer surge brakes. If you are considering use of a weight-distributing hitch system with a surge brake-equipped trailer, check with the surge brake, hitch or trailer manufacturer to determine if and how this can be done.**

Follow the instructions provided by the manufacturer for installing and using the weight-distributing hitch system.

General set-up instructions are as follows:

1. Park unloaded vehicle on a level surface. With the ignition on and the doors closed, allow the vehicle to stand for several minutes so that it can level.
2. Measure the height of a reference point on the front and rear bumpers at the center of the vehicle.

3. Attach the trailer to the vehicle and adjust the hitch equalizers so that the front bumper height is within 0 - .5 inches (0 – 13 mm) of the reference height measured in step 2. The rear bumper should be no higher than the reference height measured in step 2.

#### **⚠ WARNING**

**Properly adjust the weight distributing hitch so the rear of the bumper is no higher than the measured reference height when the trailer is attached. If the rear bumper is higher than the measured reference height when loaded, the vehicle may handle unpredictably which could cause a loss of vehicle control and cause serious personal injury or property damage.**

#### **Sway control device**

Sudden maneuvers, wind gusts, and buffeting caused by other vehicles can affect trailer handling. Sway control devices may be used to help control these affects. If you choose to use one, contact a reputable trailer hitch supplier to make sure the sway control device will work with the vehicle, hitch, trailer and the trailer's brake system. Follow the instructions provided by the manufacturer for installing and using the sway control device.

#### **Class I hitch**

Class I trailer hitch equipment (receiver, ball mount and hitch ball) can be used to tow trailers of a maximum weight of 2,000 lb (907 kg).

#### **Tire pressures**

- When towing a trailer, inflate the vehicle tires to the recommended cold tire pressure indicated on the tire placard.
- Trailer tire condition, size, load rating and proper inflation pressure should be in accordance with the trailer and tire manufacturer's specifications.

#### **Safety chains**

Always use suitable safety chains between your vehicle and the trailer. The safety chains should be crossed and should be attached to the hitch, not to the vehicle bumper or axle. The safety chains can be attached to the bumper if the hitch ball is mounted to the bumper. Be sure to leave enough slack in the chains to permit turning corners.

## Trailer lights

### CAUTION

**When splicing into the vehicle electrical system, a commercially available power-type module/converter must be used to provide power for all trailer lighting. This unit uses the vehicle battery as a direct power source for all trailer lights while using the vehicle tail light, stoplight and turn signal circuits as a signal source. The module/converter must draw no more than 15 milliamps from the stop and tail lamp circuits. Using a module/converter that exceeds these power requirements may damage the vehicle's electrical system. See a reputable trailer retailer to obtain the proper equipment and to have it installed.**

Trailer lights should comply with federal and/or local regulations. For assistance in hooking up trailer lights, contact a NISSAN dealer or reputable trailer retailer. Vehicles equipped with the optional trailer tow package are equipped with a 7-pin trailer harness connector. If your trailer is equipped with a flat 4-pin connector, an adapter will be needed to connect the trailer lights to the vehicle. Adapters are available at auto parts stores and hitch retailers.

## Pre-towing tips

- Be certain your vehicle maintains a level position when a loaded and/or unloaded trailer is hitched. Do not drive the vehicle if it has an abnormal nose-up or nose-down condition; check for improper tongue load, overload, worn suspension or other possible causes of either condition.
- Always secure items in the trailer to prevent load shift while driving.
- Keep the cargo load as low as possible in the trailer to keep the trailer center of gravity low.
- Load the trailer so approximately 60% of the trailer load is in the front half and 40% is in the back half. Also make sure the load is balanced side to side.
- Check your hitch, trailer tire pressure, vehicle tire pressure, trailer light operation, and trailer wheel lug nuts every time you attach a trailer to the vehicle.
- Be certain your rearview mirrors conform to all federal, state or local regulations. If not, install any mirrors required for towing before driving the vehicle.

- Determine the overall height of the vehicle and trailer so the required clearance is known.

## Trailer towing tips

In order to gain skill and an understanding of the vehicle's behavior, you should practice turning, stopping and backing up in an area which is free from traffic. Steering stability and braking performance will be somewhat different than under normal driving conditions.

- Always secure items in the trailer to prevent load shift while driving.
- Lock the trailer hitch coupler with a pin or lock to prevent the coupler from inadvertently becoming unlatched.
- Avoid abrupt starts, acceleration or stops.
- Avoid sharp turns or lane changes.
- Always drive your vehicle at a moderate speed.
- When backing up, hold the bottom of the steering wheel with one hand. Move your hand in the direction in which you want the trailer to go. Make small corrections and back up slowly. If possible, have someone guide you when you are backing up.

Always block the wheels on both vehicle and trailer when parking. Parking on a slope is not recommended; however, if you must do so:

 **CAUTION**

**If you move the shift lever to the P (Park) position before blocking the wheels and applying the parking brake, transmission damage could occur.**

1. Apply and hold the brake pedal.
2. Have someone place blocks on the downhill side of the vehicle and trailer wheels.
3. After the wheel blocks are in place, slowly release the brake pedal until the blocks absorb the vehicle load.
4. Apply the parking brake.
5. Shift the transmission into P (Park).
6. Turn off the engine.

To drive away:

1. Start the vehicle.
2. Apply and hold the brake pedal.
3. Shift the transmission into gear.
4. Release the parking brake.

5. Drive slowly until the vehicle and trailer are clear from the blocks.
  6. Apply and hold the brake pedal.
  7. Have someone retrieve and store the blocks.
- While going downhill, the weight of the trailer pushing on the tow vehicle may decrease overall stability. Therefore, to maintain adequate control, reduce your speed and shift to a lower gear. Avoid long or repeated use of the brakes when descending a hill, as this reduces their effectiveness and could cause overheating. Shifting to a lower gear instead provides “engine braking” and reduces the need to brake as frequently.
  - If the engine coolant temperature rises to a high temperature, refer to “If your vehicle overheats” in the “In case of emergency” section of this owner’s manual.
  - Trailer towing requires more fuel than normal circumstances.
  - Avoid towing a trailer for your vehicle’s first 500 miles (805 km).
  - For the first 500 miles (805 km) that you do tow, do not drive over 50 MPH (80 km/h).

- Have your vehicle serviced more often than at intervals specified in the recommended Maintenance Schedule in the “NISSAN Service and Maintenance Guide”.
- When making a turn, your trailer wheels will be closer to the inside of the turn than your vehicle wheels. To compensate for this, make a larger than normal turning radius during the turn.
- Crosswinds and rough roads will adversely affect vehicle/trailer handling, possibly causing vehicle sway. When being passed by larger vehicles, be prepared for possible changes in crosswinds that could affect vehicle handling.

Do the following if the trailer begins to sway:

1. Take your foot off the accelerator pedal to allow the vehicle to coast and steer as straight ahead as the road conditions allow. This combination will help stabilize the vehicle
  - Do not correct trailer sway by steering or applying the brakes.
2. When the trailer sway stops, gently apply the brakes and pull to the side of the road in a safe area.

3. Try to rearrange the trailer load so it is balanced as described earlier in this section.
- Be careful when passing other vehicles. Passing while towing a trailer requires considerably more distance than normal passing. Remember, the length of the trailer must also pass the other vehicle before you can safely change lanes.
  - Downshift the transmission to a lower gear for engine braking when driving down steep or long hills. This will help slow the vehicle without applying the brakes.
  - Avoid holding the brake pedal down too long or too frequently. This could cause the brakes to overheat, resulting in reduced braking efficiency.
  - Increase your following distance to allow for greater stopping distances while towing a trailer. Anticipate stops and brake gradually.
  - NISSAN recommends that the cruise control not be used while towing a trailer.
  - Some states or provinces have specific regulations and speed limits for vehicles that are towing trailers. Obey the local speed limits.

- Check your hitch, trailer wiring harness connections, and trailer wheel lug nuts after 50 miles (80 km) of travel and at every break.
- When launching a boat, don't allow the water level to go over the exhaust tail pipe or rear bumper.
- Make sure you disconnect the trailer lights before backing the trailer into the water or the trailer lights may burn out.

**When towing a trailer, final drive gear oil should be replaced and transmission oil/fluid should be changed more frequently. For additional information, see the "Maintenance and do-it-yourself" section earlier in this manual.**

#### FLAT TOWING FOR ALL-WHEEL DRIVE VEHICLE (if so equipped)

Towing your vehicle with all four wheels on the ground is sometimes called flat towing. This method is sometimes used when towing a vehicle behind a recreational vehicle, such as a motor home.

#### CAUTION

- **Failure to follow these guidelines can result in severe transmission damage.**
- **Whenever flat towing your vehicle, always tow forward, never backward.**
- **DO NOT tow your All-wheel drive (AWD) vehicle with any wheels on the ground. Doing so may cause serious and expensive damage to the powertrain.**
- **For emergency towing procedures refer to "Towing recommended by NISSAN" in the "In case of emergency" section of this manual.**

#### FLAT TOWING FOR FRONT WHEEL DRIVE VEHICLE (if so equipped)

Towing your vehicle with all four wheels on the ground is sometimes called flat towing. This method is sometimes used when towing a vehicle behind a recreational vehicle, such as a motor home.

## UNIFORM TIRE QUALITY GRADING

### CAUTION

- Failure to follow these guidelines can result in severe transmission damage.
- Whenever flat towing your vehicle, always tow forward, never backward.
- **DO NOT tow your front wheel drive continuously variable transmission vehicle with all four wheels on the ground (flat towing). Doing so WILL DAMAGE internal transmission parts due to lack of transmission lubrication.**
- For emergency towing procedures refer to “Towing recommended by NISSAN” in the “In case of emergency” section of this manual.

### Continuously Variable Transmission

To tow a vehicle equipped with a continuously variable transmission, an appropriate vehicle dolly **MUST** be placed under the towed vehicle's drive wheels. **Always** follow the dolly manufacturer's recommendations when using their product.

DOT (Department of Transportation) Quality Grades: All passenger car tires must conform to federal safety requirements in addition to these grades.

Quality grades can be found where applicable on the tire sidewall between tread shoulder and maximum section width. For example:

### **Treadwear 200 Traction AA Temperature A**

#### Treadwear

The treadwear grade is a comparative rating based on the wear rate of the tire when tested under controlled conditions on a specified government test course. For example, a tire graded 150 would wear one and one-half (1 1/2) times as well on the government course as a tire graded 100. The relative performance of tires depends upon the actual conditions of their use, however, and may depart significantly from the norm due to variations in driving habits, service practices and differences in road characteristics and climate.

#### Traction AA, A, B and C

The traction grades, from highest to lowest, are AA, A, B, and C. Those grades represent the tire's ability to stop on wet pavement as measured under controlled conditions on specified government test surfaces of asphalt and concrete. A tire marked C may have poor traction performance.

### WARNING

**The traction grade assigned to this tire is based on straight-ahead braking traction tests, and does not include acceleration, cornering, hydroplaning, or peak traction characteristics.**

#### Temperature A, B and C

The temperature grades are A (the highest), B, and C, representing the tire's resistance to the generation of heat, and its ability to dissipate heat when tested under controlled conditions on a specified indoor laboratory test wheel. Sustained high temperature can cause the material of the tire to degenerate and reduce tire life, and excessive temperature can lead to sudden tire failure. The grade C corresponds to a level of performance which all passenger car tires must meet under the Federal Motor Safety Standard No. 109. Grades B and A represent higher levels of performance on the laboratory test wheel than the minimum required by law.

 **WARNING**

The temperature grade for this tire is established for a tire that is properly inflated and not overloaded. Excessive speed, under-inflation, or excessive loading, either separately or in combination, can cause heat build-up and possible tire failure.

## EMISSION CONTROL SYSTEM WARRANTY

Your NISSAN vehicle is covered by the following emission warranties:

### For USA

1. Emission Defects Warranty
2. Emissions Performance Warranty

Details of this warranty may be found with other vehicle warranties in your Warranty Information Booklet which comes with your NISSAN vehicle. If you did not receive a Warranty Information Booklet, or it is lost, you may obtain a replacement by writing to:

- Nissan North America, Inc.  
Consumer Affairs Department  
P.O. Box 685003  
Franklin, TN 37068-5003

### For Canada

Emission Control System Warranty

Details of this warranty may be found with other vehicle warranties in your Warranty Information Booklet which comes with your NISSAN vehicle. If you did not receive a Warranty Information Booklet, or it is lost, you may obtain a replacement by writing to:

- Nissan Canada Inc.  
5290 Orbitor Drive  
Mississauga, Ontario, L4W 4Z5

## REPORTING SAFETY DEFECTS

### For USA

If you believe that your vehicle has a defect which could cause a crash or could cause injury or death, you should immediately inform the National Highway Traffic Safety Administration (NHTSA) in addition to notifying NISSAN.

If NHTSA receives similar complaints, it may open an investigation, and if it finds that a safety defect exists in a group of vehicles, it may order a recall and remedy campaign. However, NHTSA cannot become involved in individual problems between you, your dealer, or NISSAN.

To contact NHTSA, you may call the Vehicle Safety Hotline toll-free at 1-888-327-4236 (TTY: 1-800-424-9153); go to <http://www.safercar.gov>; or write to: Administrator, NHTSA, 400 Seventh Street, SW., Washington, D.C. 20590. You can also obtain other information about motor vehicle safety from <http://www.safercar.gov>.



You may notify NISSAN by contacting our Consumer Affairs Department, toll-free, at 1-800-NISSAN-1.

### For Canada

If you believe that your vehicle has a defect which could cause a crash or could cause injury or death, you should immediately inform Transport Canada in addition to notifying NISSAN.

If Transport Canada receives complaints, it may open an investigation, and if it finds that a safety defect exists in a group of vehicles, it may request that NISSAN conduct a recall campaign. However, Transport Canada cannot become involved in individual problems between you, your dealer, or NISSAN.

You may contact Transport Canada's Defect Investigations and Recalls Division toll free at 1-800-333-0510. You may also report safety defects online at: <https://wwwapps.tc.gc.ca/Saf-Sec-Sur/7/PCDB-BDPP/fc-cp.aspx?lang=eng> (English speakers) or <https://wwwapps.tc.gc.ca/Saf-Sec-Sur/7/PCDB-BDPP/fc-cp.aspx?lang=fra> (French speakers)

Additional information concerning motor vehicle safety may be obtained from Transport Canada's Road Safety Information Centre at 1-800-333-0371 or online at [www.tc.gc.ca/roadsafety](http://www.tc.gc.ca/roadsafety) (English speakers) or [www.tc.gc.ca/securiteroutiere](http://www.tc.gc.ca/securiteroutiere) (French speakers).

To notify NISSAN of any safety concerns please contact our Consumer Information Centre toll free at 1-800-387-0122.

## READINESS FOR INSPECTION/ MAINTENANCE (I/M) TEST

### WARNING

**A vehicle equipped with All -Wheel Drive (AWD) should never be tested using a two wheel dynamometer (such as the dynamometers used by some states for emissions testing), or similar equipment. Make sure you inform the test facility personnel that your vehicle is equipped with AWD before it is placed on a dynamometer. Using the wrong test equipment may result in drivetrain damage or unexpected vehicle movement which could result in serious vehicle damage or personal injury.**

Due to legal requirements in some states and Canadian Provinces, your vehicle may be required to be in what is called the "ready condition" for an Inspection/Maintenance (I/M) test of the emission control system.

The vehicle is set to the "ready condition" when it is driven through certain driving patterns. Usually, the ready condition can be obtained by ordinary usage of the vehicle.

## EVENT DATA RECORDERS (EDR)

If a powertrain system component is repaired or the battery is disconnected, the vehicle may be reset to a “not ready” condition. Before taking the I/M test, check the vehicle’s inspection/maintenance test readiness condition. Place the ignition switch in the ON position without starting the engine. If the Malfunction Indicator Light (MIL) comes on steady for 20 seconds and then blinks for 10 seconds, the I/M test condition is “not ready”. If the MIL does not blink after 20 seconds, the I/M test condition is “ready”. Contact a NISSAN dealer to set the “ready condition” or to prepare the vehicle for testing.

This vehicle is equipped with an Event Data Recorder (EDR). The main purpose of an EDR is to record, in certain crash or near crash-like situations, such as an air bag deployment or hitting a road obstacle, data that will assist in understanding how a vehicle’s systems performed. The EDR is designed to record data related to vehicle dynamics and safety systems for a short period of time, typically 30 seconds or less. The EDR in this vehicle is designed to record such data as:

- How various systems in your vehicle were operating;
- Whether or not the driver and passenger safety belts were buckled/fastened;
- How far (if at all) the driver was depressing the accelerator and/or brake pedal; and,
- How fast the vehicle was traveling.
- Sounds are not recorded.

These data can help provide a better understanding of the circumstances in which crashes and injuries occur. NOTE: EDR data are recorded by your vehicle only if a nontrivial crash situation occurs; no data are recorded by the EDR under normal driving conditions and no personal data (e.g. name, gender, age and crash location) are recorded. However, other parties, such as law enforcement, could combine the EDR data with the type of personally identifying data routinely acquired during a crash investigation.

To read data recorded by an EDR, special equipment is required and access to the vehicle or the EDR is needed. In addition to the vehicle manufacturer and NISSAN dealer, other parties, such as law enforcement, that have the special equipment, can read the information if they have access to the vehicle or the EDR. EDR data will only be accessed with the consent of the vehicle owner or lessee or as otherwise required or permitted by law.

## **OWNER'S MANUAL/SERVICE MANUAL ORDER INFORMATION**

Genuine NISSAN Service Manuals for this model year and prior can be purchased. A genuine NISSAN Service Manual is the best source of service and repair information for your vehicle. This manual is the same one used by the factory-trained technicians working at NISSAN dealerships. Genuine NISSAN Owner's Manuals can also be purchased.

### **For USA**

For current pricing and availability of genuine **NISSAN Service Manuals**, contact:

1-800-450-9491

[www.nissan-techinfo.com](http://www.nissan-techinfo.com)

For current pricing and availability of genuine **NISSAN Owner's Manuals**, contact:

1-800-247-5321

### **For Canada**

To purchase a copy of a genuine NISSAN Service Manual or Owner's Manual, for this model year and prior, please contact your nearest NISSAN dealer. For the phone number and location of a NISSAN dealer in your area, call the NISSAN Information Center at 1-800-387-0122 and a bilingual NISSAN representative will assist you.

# 10 Index

## A

Active Head Restraint . . . . . 1-6  
Air bag (See supplemental restraint system) . . . . . 1-41  
Air bag system  
    Front (See supplemental front impact air bag system) . . . . . 1-48  
Air bag warning labels . . . . . 1-56  
Air bag warning light. . . . . 1-56, 2-13  
Air cleaner housing filter . . . . . 8-17  
Air conditioner  
    Air conditioner operation . . . . . 4-29  
    Air conditioner service . . . . . 4-37  
    Air conditioner specification label . . . . . 9-12  
    Air conditioner system refrigerant and oil recommendations . . . . . 9-7  
    Heater and air conditioner controls . . . . . 4-26, 4-35  
    Servicing air conditioner . . . . . 4-37  
Air flow charts. . . . . 4-30  
Alarm system  
(See vehicle security system) . . . . . 2-30  
Anchor point locations . . . . . 1-26  
Antenna . . . . . 4-77  
Anti-lock brake warning light. . . . . 2-10  
Anti-lock Braking System (ABS). . . . . 5-38  
Armrests. . . . . 1-12  
Around View™ Monitor . . . . . 4-15  
Audible reminders . . . . . 2-16  
Audio system . . . . . 4-37  
    Bluetooth® audio . . . . . 4-73, 4-74

    Compact disc (CD) player . . . . . 4-48, 4-52, 4-57, 4-62  
    FM/AM/SAT radio with compact disc (CD) player . . . . . 4-46, 4-50, 4-54, 4-60  
Audio System  
    iPod® Player. . . . . 4-68, 4-70  
Audio system  
    Radio . . . . . 4-37  
    USB interface . . . . . 4-64, 4-66  
Autolight switch. . . . . 2-36  
Automatic  
    Automatic power window switch . . . . . 2-52  
Automatic anti-glare inside mirror . . . . . 3-32  
Automatic door locks . . . . . 3-6  
AUX jack . . . . . 4-64

## B

Battery . . . . . 8-13  
    Charge warning light . . . . . 2-10  
Before starting the engine . . . . . 5-13  
Belt (See drive belt) . . . . . 8-16  
Block heater  
    Engine . . . . . 5-47  
Bluetooth® audio . . . . . 4-73, 4-74  
Bluetooth® hands-free phone system . . . . . 4-79, 4-91  
Booster seats . . . . . 1-38  
Brake  
    Anti-lock Braking System (ABS). . . . . 5-38  
    Brake light (See stop light). . . . . 8-29  
    Brake system . . . . . 5-37

    Brake warning light . . . . . 2-10  
    Brake wear indicators . . . . . 2-16, 8-20  
    Parking brake operation . . . . . 5-19  
    Self-adjusting brakes . . . . . 8-20  
Brakes . . . . . 8-20  
Break-in schedule . . . . . 5-34  
Brightness/contrast button . . . . . 4-9  
Brightness control  
    Instrument panel . . . . . 2-37  
Bulb check/instrument panel . . . . . 2-9  
Bulb replacement . . . . . 8-29

## C

Capacities and recommended fuel/lubricants. . . . . 9-2  
Cargo light . . . . . 2-56  
Cargo (See vehicle loading information) . . . . . 9-14  
Car phone or CB radio. . . . . 4-79  
CD care and cleaning . . . . . 4-75  
CD player  
(See audio system) . . . . . 4-48, 4-52, 4-57, 4-62  
Check tire pressure. . . . . 2-28  
Child restraints. . . . . 1-20, 1-21, 1-22, 1-24  
    Precautions on child restraints . . . . . 1-22, 1-29, 1-33, 1-38  
    Top tether strap anchor point locations . . . . . 1-26  
Child restraint with top tether strap . . . . . 1-26  
Child safety rear door lock. . . . . 3-7  
Chimes, audible reminders. . . . . 2-16  
Cleaning exterior and interior . . . . . 7-2  
C.M.V.S.S. certification label. . . . . 9-11

Cold weather driving . . . . .	5-46
Compact disc (CD) player . . . . .	4-48, 4-52, 4-57, 4-62
Console box . . . . .	2-47
Continuously Variable Transmission (CVT) . . . . .	5-15
Continuously Variable Transmission (CVT) fluid . . . . .	8-12
Driving with Continuously Variable Transmission (CVT) . . . . .	5-15
Control panel buttons . . . . .	4-4
Brightness/contrast button . . . . .	4-9
Enter button . . . . .	4-4
Setting button . . . . .	4-7
Controls	
Heater and air conditioner controls . . . . .	4-26, 4-35
Coolant	
Capacities and recommended fuel/lubricants . . . . .	9-2
Changing engine coolant . . . . .	8-8
Checking engine coolant level . . . . .	8-8
Engine coolant temperature gauge . . . . .	2-5
Corrosion protection . . . . .	7-5
Cruise control . . . . .	5-27
Cup holders . . . . .	2-45

## D

Daytime running light system (Canada only) . . . . .	2-37
Defroster switch	
Rear window and outside mirror defroster switch . . . . .	2-34
Dimensions and weights . . . . .	9-9
Dimmer switch for instrument panel . . . . .	2-37
Display controls (see control panel buttons) . . . . .	4-4

Door locks . . . . .	3-5
Drive belt . . . . .	8-16
Driving	
Cold weather driving . . . . .	5-46
Driving with Continuously Variable Transmission (CVT) . . . . .	5-15
Precautions when starting and driving . . . . .	5-2

## E

Economy - fuel . . . . .	5-35
Emission control information label . . . . .	9-11
Emission control system warranty . . . . .	9-29
Engine	
Before starting the engine . . . . .	5-13
Block heater . . . . .	5-47
Capacities and recommended fuel/lubricants . . . . .	9-2
Changing engine coolant . . . . .	8-8
Changing engine oil . . . . .	8-10
Changing engine oil filter . . . . .	8-11
Checking engine coolant level . . . . .	8-8
Checking engine oil level . . . . .	8-9
Engine compartment check locations . . . . .	8-6
Engine coolant temperature gauge . . . . .	2-5
Engine cooling system . . . . .	8-7
Engine oil . . . . .	8-9
Engine oil and oil filter recommendation . . . . .	9-6
Engine oil viscosity . . . . .	9-6
Engine serial number . . . . .	9-11
Engine specifications . . . . .	9-8
Starting the engine . . . . .	5-13, 5-14
Enter button . . . . .	4-4
Event data recorders . . . . .	9-31
Exhaust gas (Carbon monoxide) . . . . .	5-2

Extended storage switch . . . . .	8-24
Eyeglass case . . . . .	2-44

## F

Flashers (See hazard warning flasher switch) . . . . .	6-2
Flat tire . . . . .	6-3
Floor mat positioning aid . . . . .	7-5
Fluid	
Capacities and recommended fuel/lubricants . . . . .	9-2
Continuously Variable Transmission (CVT) fluid . . . . .	8-12
Engine coolant . . . . .	8-7
Engine oil . . . . .	8-9
Windshield-washer fluid . . . . .	8-12
F.M.V.S.S. certification label . . . . .	9-11
Fog light switch . . . . .	2-38
Forward Collision Warning system . . . . .	5-29
Front air bag system (See supplemental restraint system) . . . . .	1-48
Front seats . . . . .	1-2
Fuel	
Capacities and recommended fuel/lubricants . . . . .	9-2
Fuel economy . . . . .	5-35
Fuel-filler door and cap . . . . .	3-27
Fuel-filler door lock opener lever . . . . .	3-27
Fuel gauge . . . . .	2-5
Fuel octane rating . . . . .	9-5
Fuel recommendation . . . . .	9-4
Loose fuel cap warning . . . . .	2-28, 3-27
Fuses . . . . .	8-21
Fusible links . . . . .	8-23

## G

Garage door opener, HomeLink® Universal Transceiver . . . . .	.2-56
Gas cap . . . . .	.3-27
Gauge	
Engine coolant temperature gauge . . . . .	.2-5
Fuel gauge . . . . .	.2-5
Odometer . . . . .	.2-4
Speedometer . . . . .	.2-4
Tachometer . . . . .	.2-4
Trip odometer . . . . .	.2-4
General maintenance . . . . .	.8-2
Glove box . . . . .	.2-46
Glove box lock . . . . .	.2-46

## H

Hands-free phone system, Bluetooth® . . . . .	.4-79, 4-91
Hazard warning flasher switch . . . . .	.6-2
Headlight and turn signal switch . . . . .	.2-35
Headlight control switch . . . . .	.2-35
Headlights . . . . .	.8-27
Head restraints	
Active Head Restraint . . . . .	.1-6
Heated seats . . . . .	.2-39
Heater	
Heater and air conditioner controls . . . . .	.4-26, 4-35
Heater operation . . . . .	.4-28, 4-36
Hill descent control switch . . . . .	.2-41
Hill descent control system . . . . .	.5-44
Hill start assist system . . . . .	.5-45

HomeLink® Universal Transceiver . . . . .	.2-56
Hood release . . . . .	.3-22
Hook	
Luggage hook . . . . .	.2-47
Horn . . . . .	.2-38

## I

Ignition switch . . . . .	.5-8
Ignition Switch	
Push-Button Ignition Switch . . . . .	.5-10
Immobilizer system . . . . .	.2-31, 3-4, 5-9, 5-13
Important vehicle information label . . . . .	.9-11
In-cabin microfilter . . . . .	.8-18
Increasing fuel economy . . . . .	.5-35
Indicator lights and audible reminders (See warning/indicator lights and audible reminders) . . . . .	.2-9
Inside automatic anti-glare mirror . . . . .	.3-32
Inside mirror . . . . .	.3-31
Instrument brightness control . . . . .	.2-37
Instrument panel . . . . .	.0-6, 2-2
Instrument panel dimmer switch . . . . .	.2-37
Intelligent Key system	
Key operating range . . . . .	.3-12
Key operation . . . . .	.3-14
Mechanical key . . . . .	.3-4
Remote keyless entry operation . . . . .	.3-17
Troubleshooting guide . . . . .	.3-20
Warning signals . . . . .	.3-20
Interior light . . . . .	.2-54
iPod® Player . . . . .	.4-68, 4-70
ISOFIX child restraints . . . . .	.1-24

## J

Jump starting . . . . .	.6-10
-------------------------	-------

## K

Keyfob battery replacement . . . . .	.8-25
Keyless entry	
With Intelligent Key system (See Intelligent Key system) . . . . .	.3-17
Keyless entry system (See remote keyless entry system) . . . . .	.3-2
Keys, For Intelligent Key system . . . . .	.3-2, 3-11

## L

Labels	
Air conditioner specification label . . . . .	.9-12
C.M.V.S.S. certification label . . . . .	.9-11
Emission control information label . . . . .	.9-11
Engine serial number . . . . .	.9-11
F.M.V.S.S. certification label . . . . .	.9-11
Tire and Loading Information label . . . . .	.9-12
Vehicle identification number (VIN) plate . . . . .	.9-10
Warning labels (for SRS) . . . . .	.1-56
LATCH (Lower Anchors and Tethers for Children) System . . . . .	.1-24
License plate	
Installing the license plate . . . . .	.9-13
Lift gate . . . . .	.3-23
Lift gate release . . . . .	.3-26
Light	
Air bag warning light . . . . .	.1-56, 2-13
Brake light (See stop light) . . . . .	.8-29

Bulb check/instrument panel . . . . .	2-9
Bulb replacement . . . . .	8-29
Charge warning light . . . . .	2-10
Fog light switch . . . . .	2-38
Headlight and turn signal switch . . . . .	2-35
Headlight control switch . . . . .	2-35
Headlights . . . . .	8-27
Interior light. . . . .	2-54
Light bulbs . . . . .	8-27
Low tire pressure warning light . . . . .	2-11
Low windshield-washer fluid warning light . . . . .	2-28
Passenger air bag and status light . . . . .	1-50
Security indicator light. . . . .	2-15
Spotlights (See map light) . . . . .	2-55
Warning/indicator lights and audible reminders . . . . .	2-9
Lights	
Map lights . . . . .	2-55
Lock	
Child safety rear door lock . . . . .	3-7
Door locks . . . . .	3-5
Fuel-filler door lock opener lever . . . . .	3-27
Glove box lock . . . . .	2-46
Lift gate release . . . . .	3-26
Power door locks . . . . .	3-6
Loose fuel cap warning. . . . .	2-28, 3-27
Low fuel warning light . . . . .	2-12, 2-28
Low tire pressure warning light . . . . .	2-11
Low windshield-washer fluid warning light. . . . .	2-28
Luggage hook . . . . .	2-47
Luggage rack (see roof rack) . . . . .	2-48
Luggage (See vehicle loading information) . . . . .	9-14
Luggage storage (see vehicle loading information) . . . . .	2-48

**M**

Maintenance	
General maintenance . . . . .	8-2
Inside the vehicle . . . . .	8-3
Maintenance precautions . . . . .	8-5
Outside the vehicle . . . . .	8-2
Seat belt maintenance. . . . .	1-19
Under the hood and vehicle . . . . .	8-4
Malfunction indicator light . . . . .	2-15
Manual front seat adjustment. . . . .	1-2
Map lights . . . . .	2-55
Meters and gauges . . . . .	2-3
Instrument brightness control. . . . .	2-37
Mirror	
Automatic anti-glare inside mirror. . . . .	3-32
Inside mirror . . . . .	3-31
Outside mirror control . . . . .	3-33
Outside mirrors . . . . .	3-33
Vanity mirror . . . . .	3-31
Moonroof. . . . .	2-52
Multi-remote control system (See remote keyless entry system). . . . .	3-2

**N**

NISSAN Intelligent Key® . . . . .	3-3
NISSAN vehicle immobilizer system . . . . .	2-31, 3-4, 5-9, 5-13
NISSAN voice recognition system . . . . .	4-98

**O**

Octane rating (See fuel octane rating). . . . .	9-5
---	-----

Odometer . . . . .	2-4
Oil	
Capacities and recommended fuel/lubricants . . . . .	9-2
Changing engine oil . . . . .	8-10
Changing engine oil filter . . . . .	8-11
Checking engine oil level . . . . .	8-9
Engine oil . . . . .	8-9
Engine oil and oil filter recommendation . . . . .	9-6
Engine oil viscosity . . . . .	9-6
One shot call. . . . .	4-82, 4-82, 4-93
Outside mirror control . . . . .	3-33
Outside mirrors . . . . .	3-33
Overheat	
If your vehicle overheats. . . . .	6-12
Owner's manual order form . . . . .	9-32
Owner's manual/service manual order information . . . . .	9-32

**P**

Parking	
Parking brake operation . . . . .	5-19
Parking/parking on hills . . . . .	5-36
Phone, Bluetooth® hands-free system . . . . .	4-79, 4-91
Power	
Front seat adjustment . . . . .	1-4
Power door locks . . . . .	3-6
Power outlet . . . . .	2-42
Power rear windows . . . . .	2-51
Power steering system . . . . .	5-37
Power windows . . . . .	2-50
Rear power windows . . . . .	2-51

Precautions	
Maintenance precautions . . . . .	8-5
Precautions on child restraints . . . . .	1-22, 1-29, 1-33, 1-38
Precautions on seat belt usage . . . . .	1-13
Precautions on supplemental restraint system . . . . .	1-41
Precautions when starting and driving . . . . .	5-2
Pre-tensioner seat belt system . . . . .	1-55
Programmable features . . . . .	4-7
Push starting . . . . .	6-12

## R

Radio	
Car phone or CB radio . . . . .	4-79
FM/AM/SAT radio with compact disc (CD) player . . . . .	4-46, 4-50, 4-54, 4-60
Readiness for inspection maintenance (I/M) test . . . . .	9-30
Rear power windows . . . . .	2-51
RearView Monitor . . . . .	4-10
Rear window and outside mirror defroster switch . . . . .	2-34
Rear window wiper and washer switches . . . . .	2-33
Recorders	
Event data . . . . .	9-31
Refrigerant recommendation . . . . .	9-7
Registering your vehicle in another country . . . . .	9-10
Remote keyless entry system . . . . .	3-2
Reporting safety defects (US only) . . . . .	9-29
Roof rack . . . . .	2-48

## S

Safety	
Child safety rear door lock . . . . .	3-7
Child seat belts . . . . .	1-22, 1-29, 1-33, 1-38
Reporting safety defects (US only) . . . . .	9-29
Seat adjustment	
Front manual seat adjustment . . . . .	1-2
Front power seat adjustment . . . . .	1-4
Second row bench seats . . . . .	1-5
Seatback pockets . . . . .	2-44
Seat belt	
Child safety . . . . .	1-20
Infants and small children . . . . .	1-21
Injured Person . . . . .	1-16
Larger children . . . . .	1-21
Precautions on seat belt usage . . . . .	1-13
Pregnant women . . . . .	1-16
Pre-tensioner seat belt system . . . . .	1-55
Seat belt extenders . . . . .	1-19
Seat belt maintenance . . . . .	1-19
Seat belts . . . . .	1-13
Shoulder belt height adjustment . . . . .	1-18
Three-point type with retractor . . . . .	1-16
Seat belt warning light . . . . .	2-13
Seats	
Adjustment . . . . .	1-2
Front seats . . . . .	1-2
Heated seats . . . . .	2-39
Manual front seat adjustment . . . . .	1-2
Security indicator light . . . . .	2-15
Security system (NISSAN vehicle immobilizer system), engine start . . . . .	2-31, 3-4, 5-9, 5-13
Self-adjusting brakes . . . . .	8-20
Service manual order form . . . . .	9-32

Servicing air conditioner . . . . .	4-37
Setting button . . . . .	4-7
Shoulder belt height adjustment . . . . .	1-18
Spark plug replacement . . . . .	8-16
Speedometer . . . . .	2-4
Spotlights (See map light) . . . . .	2-55
SRS warning label . . . . .	1-56
Starting	
Before starting the engine . . . . .	5-13
Jump starting . . . . .	6-10
Precautions when starting and driving . . . . .	5-2
Push starting . . . . .	6-12
Starting the engine . . . . .	5-13, 5-14
Steering	
Power steering system . . . . .	5-37
Stop light . . . . .	8-29
Storage . . . . .	2-44
Storage bin . . . . .	2-48
Sunglasses case . . . . .	2-44
Sunglasses holder . . . . .	2-44
Sunroof (see Moonroof) . . . . .	2-52
Sun visors . . . . .	3-30
Supplemental air bag warning labels . . . . .	1-56
Supplemental air bag warning light . . . . .	1-56, 2-13
Supplemental front impact air bag system . . . . .	1-48
Supplemental restraint system	
Information and warning labels . . . . .	1-56
Precautions on supplemental restraint system . . . . .	1-41
Supplemental restraint system (Supplemental air bag system) . . . . .	1-41
Switch	
Autolight switch . . . . .	2-36
Automatic power window switch . . . . .	2-52
Fog light switch . . . . .	2-38
Hazard warning flasher switch . . . . .	6-2



Headlight and turn signal switch . . . . .	.2-35
Headlight control switch . . . . .	.2-35
Hill descent control switch . . . . .	.2-41
Ignition switch . . . . .	.5-8
Power door lock switch . . . . .	.3-6
Rear window and outside mirror defroster switch. . . . .	.2-34
Rear window wiper and washer switches . . . . .	.2-33
Turn signal switch . . . . .	.2-38
Vehicle dynamic control (VDC) off switch. . . . .	.2-40
Windshield wiper and washer switch . . .	.2-32

## T

Tachometer . . . . .	.2-4
Temperature gauge	
Engine coolant temperature gauge . . . .	.2-5
Theft (NISSAN vehicle immobilizer system), engine start. . . . .	.2-31, 3-4, 5-9, 5-13
Three-way catalyst . . . . .	.5-2
Tire	
Flat tire . . . . .	.6-3
Spare tire . . . . .	.6-5
Tire and Loading Information label . . . .	.9-12
Tire chains . . . . .	.8-40
Tire placard. . . . .	.9-12
Tire pressure . . . . .	.8-32
Tire rotation. . . . .	.8-41
Types of tires. . . . .	.8-38
Uniform tire quality grading . . . . .	.9-28
Wheels and tires. . . . .	.8-32
Wheel/tire size. . . . .	.9-9

Tire pressure	
Low tire pressure warning light . . . . .	.2-11
Tire Pressure Monitoring System (TPMS) . . .	.5-3
Top tether strap child restraint . . . . .	.1-26
Towing	
Flat towing . . . . .	.9-27
Towing load/specification . . . . .	.9-22
Tow truck towing. . . . .	.6-13
Trailer towing. . . . .	.9-18
Transceiver	
HomeLink® Universal Transceiver . . . .	.2-56
Transmission	
Continuously Variable Transmission (CVT) fluid . . . . .	.8-12
Driving with Continuously Variable Transmission (CVT) . . . . .	.5-15
Travel (See registering your vehicle in another country). . . . .	.9-10
Trip odometer . . . . .	.2-4
Turn signal switch . . . . .	.2-38

## U

Uniform tire quality grading . . . . .	.9-28
USB interface	
Audio file operation. . . . .	.4-65, 4-67

## V

Vanity mirror . . . . .	.3-31
Variable voltage control system. . . . .	.8-16
Vehicle dimensions and weights . . . . .	.9-9
Vehicle dynamic control (VDC) off switch . .	.2-40
Vehicle dynamic control (VDC) system. . . .	.5-39

Vehicle identification . . . . .	.9-10
Vehicle identification number (VIN) (Chassis number) . . . . .	.9-10
Vehicle identification number (VIN) plate. . .	.9-10
Vehicle loading information . . . . .	.9-14
Vehicle recovery . . . . .	.6-16
Vehicle security system . . . . .	.2-30
Vehicle security system (NISSAN vehicle immobilizer system), engine start . . .	.2-31, 3-4, 5-9, 5-13
Ventilators . . . . .	.4-25
Visors . . . . .	.3-30
Voice Prompt Interrupt . . . . .	.4-82, 4-93
Voice recognition system . . . . .	.4-98

## W

Warning	
Air bag warning light . . . . .	.1-56, 2-13
Anti-lock brake warning light . . . . .	.2-10
Battery charge warning light . . . . .	.2-10
Brake warning light . . . . .	.2-10
Hazard warning flasher switch . . . . .	.6-2
Low fuel warning light . . . . .	.2-12, 2-28
Low tire pressure warning light . . . . .	.2-11
Low windshield-washer fluid warning light . . . . .	.2-28
Passenger air bag and status light . . . .	.1-50
Seat belt warning light. . . . .	.2-13
Vehicle security system . . . . .	.2-30
Warning/indicator lights and audible reminders . . . . .	.2-9
Warning labels (for SRS) . . . . .	.1-56
Warning lights . . . . .	.2-9

Washer switch	
Rear window wiper and washer switches . . . . .	.2-33
Windshield wiper and washer switch . . .	.2-32
Weights (See dimensions and weights) . . . .	.9-9
Wheels and tires. . . . .	.8-32
Wheel/tire size. . . . .	.9-9
When traveling or registering your vehicle in another country . . . . .	.9-10
Windows	
Locking passengers' windows . . . . .	.2-51
Power rear windows. . . . .	.2-51
Power windows . . . . .	.2-50
Rear power windows . . . . .	.2-51
Windshield-washer fluid. . . . .	.8-12
Windshield wiper and washer switch . . . .	.2-32
Wiper	
Rear window wiper and washer switches . . . . .	.2-33
Windshield wiper and washer switch . . .	.2-32
Wiper blades. . . . .	.8-18

## GAS STATION INFORMATION

### RECOMMENDED FUEL:

Use unleaded regular gasoline with an octane rating of at least 87 AKI (Anti-Knock Index) number (Research octane number 91).

#### CAUTION

- **Using a fuel other than that specified could adversely affect the emission control system, and may also affect the warranty coverage.**
- **Under no circumstances should a leaded gasoline be used, because this will damage the three-way catalyst.**
- **Do not use E-15 or E-85 fuel in your vehicle. Your vehicle is not designed to run on E-15 or E-85 fuel. Using E-15 or E-85 fuel in a vehicle not specifically designed for E-15 or E-85 fuel can adversely affect the emission control devices and systems of the vehicle. Damage caused by such fuel is not covered by the NISSAN new vehicle limited warranty.**

- **U.S. government regulations require ethanol dispensing pumps to be identified by a small, square, orange and black label with the common abbreviation or the appropriate percentage for that region.**

For additional information, see “Recommended fluids/lubricants and capacities” in the “Technical and consumer information” section.

### RECOMMENDED ENGINE OIL:

- Genuine NISSAN engine oil or equivalent
- Engine oil with API Certification Mark
- Viscosity SAE 0W-20

See “Engine oil and oil filter recommendations” in the “Technical and consumer information” section of this manual.

### COLD TIRE PRESSURE:

See Tire and Loading Information label.

The label is typically located on the driver side center pillar or on the driver's door. For additional information, see “Wheels and tires” in the “Maintenance and do-it-yourself” section of this manual.

### RECOMMENDED NEW VEHICLE BREAK-IN PROCEDURE:

During the first 1,200 mi (2,000 km) of vehicle use, follow the recommendations outlined in the “Break-in schedule” information found in the “Starting and driving” section of this manual. Follow these recommendations for the future reliability and economy of your new vehicle. Failure to follow these recommendations may result in vehicle damage or shortened engine life.



Printing : December 2013 (02)  
Publication No.: OM14E 0T32U1  
Printed in U.S.A.  
T00UM-JM03D

T32-D